

REGAL



OWNER'S MANUAL 26 EXPRESS/ 26 XO

4-2019

California Proposition 65

CALIFORNIA PROPOSITION 65

Boats manufactured for use in California for model year 2018 and after meet the California EVAP Emissions regulation for spark-ignition marine watercraft. Boats meeting this requirement will have a label affixed near the helm.

WARNING

Operating, servicing and maintaining a recreational marine vessel can expose you to chemicals including engine exhaust, carbon monoxide, phthalates, and lead, which are known to the State of California to cause cancer and birth defects or other reproductive harm. To minimize exposure, avoid breathing exhaust, service your vessel in a well-ventilated area and wear gloves or wash your hands frequently when servicing this vessel. For more information go to: www.P65warnings.ca.gov/marine.

The fuel system in this boat complies with U.S. EPA mandated evaporative emission standards at time of manufacture using certified components.

MANUFACTURER'S WARRANTY COVERAGE

This evaporative emission control system is warranted for two years. If any evaporative emission-related part on your spark-ignition marine watercraft is defective, the part will be repaired by Regal Marine Industries, Inc.

OWNER'S MANUAL/RESPONSIBILITIES

- As the spark-ignition marine watercraft owner, you are responsible for the performance of the required maintenance listed in your owner's manual. Regal Marine Industries, Inc. recommends that you retain all receipts covering maintenance on your spark-ignition marine watercraft, but Regal Marine Industries, Inc. cannot deny warranty solely on the lack of receipts.
- As the owner, you should be aware that Regal Marine Industries, Inc. may deny you warranty coverage of your spark-ignition marine watercraft or a part has failed due to abuse, neglect, or improper maintenance or unapproved modifications.
- You are responsible for presenting your spark-ignition marine watercraft to a Regal Marine Industries, Inc. distribution center or a service center as soon as the problem exists. The warranty repairs should be completed in a reasonable amount of time, not to exceed 30 days. If you have any questions regarding your warranty coverage, you should contact Regal Marine Industries, Inc. at 407-851-4360.

Notes

The information found in this owner's manual may change at any time.

Designated items referred to may not be installed on your vessel. In keeping with its commitment to continued product improvement Regal Marine Industries, Inc. reserves the right to modify the vessel at any time without notice including changes in specifications, colors, fabrics, materials and equipment or to discontinue a model. Regal is not obligated to make similar changes or modifications to models sold prior to the date of such changes.

All specifications are approximate including weights, fuel figures and speeds. Speeds are calculated at sea level with a temperature of 70 to 85 degrees. Increases in altitude and/or temperature will reduce horsepower and thereby reduce the speed of the vessel.

All information is for reference only and should be used as a guideline. Consult local and state guidelines as they may differ in your area. Any decisions relating to safe operation of the vessel are the responsibility of the operator.



Table Of Contents

	Chapter	Page
1	INTRODUCTION	5
2	SAFETY ON BOARD	18
3	RULES OF THE ROAD	41
4	SYSTEMS	52
5	ENGINES/CONTROLS	134
6	VESSEL OPERATION/TRAILERING	184
7	AUXILIARY EQUIPMENT	207
8	COSMETIC CARE/MAINTENANCE	242
9	TROUBLESHOOTING	289
10.	STORAGE/WINTERIZATION	305
11.	GLOSSARY/INDEX	306
12.	TECHNICAL	313
	26EX DRAWINGS	322
	26XO DRAWINGS	368

Introduction



Boating is becoming more popular each and every year. There are numerous types of recreational vessels on our waterways today involved in an every growing number of activities. Therefore, as a Regal boat owner it is of the highest priority to learn about general boating practices before operating your vessel.

Your Regal dealer will answer many questions and provide valuable “hands on” information during the completion of the new boat delivery process. In addition, your dealer has received special factory training on the product line and his services should be employed to solve any technical problems and periodic maintenance beyond the scope of this manual. Your Regal dealer carries a line of factory approved parts and accessories.

Your Regal dealer can provide information regarding national training organizations such as the U.S. Power Squadron and United States Coast Guard Auxiliary. Along with other organizations and literature, they can help build your “boating savvy” by developing the necessary skills and awareness to be a safe and confident skipper.

Also, your local library can assist in providing recommended boating literature such as Chapman Piloting Seamanship & Boat Handling by Elbert S. Maloney.

Furthermore, boating information is available on the internet. Remember, waterway conditions can change in a heartbeat. Knowing how to react quickly comes from experience and knowledge which can be gained through boating education. Welcome aboard!



WELCOME TO REGAL

I know I speak for everyone at Regal when I welcome you to the ever-growing family of Regal boat owners. You've chosen a boat that is recognized worldwide for its standard of excellence. Each step in construction has been carefully scrutinized to assure safety, performance, reliability and comfort for both your passengers and yourself.

Your yacht is certified by the National Marine Manufacturers Association. It also complies with the applicable standards set by the United States Coast Guard, American Boat and Yacht Council and the International Marine Certification Institute. Your Regal boat was built with the same attention to detail and quality of construction that we would expect in a craft we would purchase ourselves.

Whether you're a veteran boater or a newcomer, we strongly urge you to read this owner's manual thoroughly. Familiarize yourself with the various components of your vessel, and heed the safety precautions noted herein.

If you have questions that are not covered in this manual, please consult your authorized Regal dealer for assistance, phone the Regal factory at 407-851-4360 or E-mail us at www.regalboats.com.

Thank you, and welcome to the "World of Regal!"

*Duane Kuck
President & CEO*

Introduction

REGAL MARINE INDUSTRIES, INC. MISSION STATEMENT

With God's help

and a steadfast commitment to integrity,

we will develop a team

of exceptional people and relationships

to provide exceptional customer satisfaction.



Chapter 1

REGAL OWNER'S MANUAL

Your Regal owner's manual has been compiled with information to assist you in operating your craft with safety and pleasure. **This manual targets specific details of Regal related systems and components along with their location, operation and maintenance that normally is not found in the vendor information. In addition, supplier related equipment information is located within the owner's information package.**

OWNER'S INFO PACKET

An owner's information packet (black satchel) is located on the vessel. *Read and become familiar with the materials.* This packet contains valuable literature on your propulsion package, standard and optional equipment, systems, various care and cleaning instructions along with component warranty and instructional information.

Store the information packet in a clean, dry location.

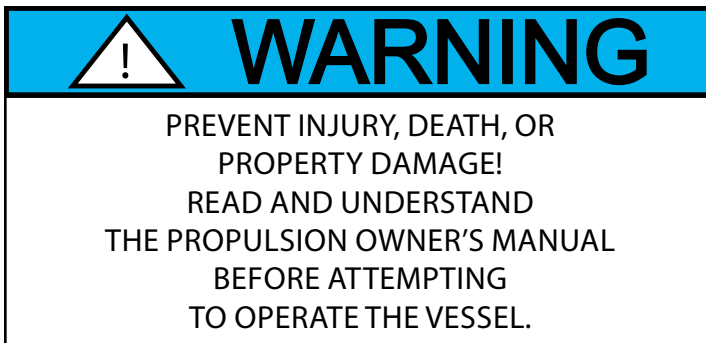

The Regal owner's manual is not to be thought of as a complete shop technical document. Beside the system chapters, there is troubleshooting information devoted to select current standard and optional equipment. In addition, refer to the engine and generator (if installed) operator's manuals. More detailed information may exist in the owner's packet associated with that component.

Remember that your Regal dealer has received special factory training and his services should be employed to solve more technical problems. Call 407-851-4360 or go to the internet at www.RegalBoats.com to find the closest Regal dealership.

In keeping with its commitment to improvement Regal Marine Industries, Inc. is continually upgrading the product line. Regal notes that all dimensions, specifications, models, standard and optional equipment is subject to change without notice at any time.

Introduction

GENERAL INFORMATION

HULL IDENTIFICATION NUMBER (HIN)

The United States Coast Guard has established a universal system of numerically recognizing vessels by using a hull identification number or "HIN." This number identifies your Regal yacht's model, hull number, month and year of manufacture. The HIN is normally found on your boat's transom, on the starboard side, just below the rub rail on the transom vertical surface. The HIN is stamped on a plate and reinforced with a special adhesive. The HIN consists of 12 alpha or numeric characters.

It is recommended that you locate and write down the HIN for future reference. It can be especially useful when ordering parts from your Regal dealer. A second HIN number is found in a hidden location. This second HIN is useful to authorities if the vessel is stolen and/or the original transom HIN is modified or eliminated.

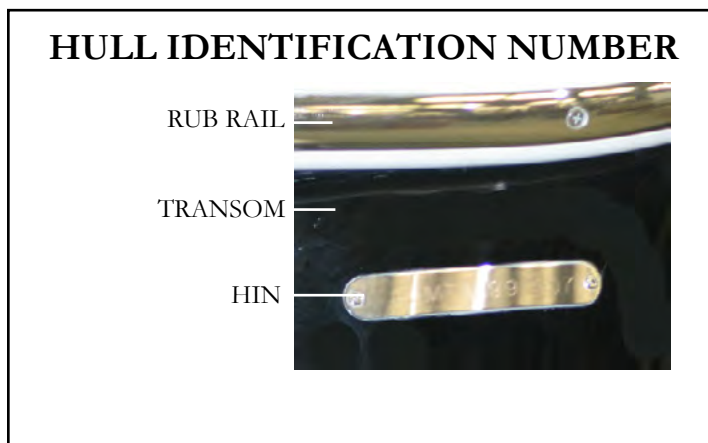

VESSEL INFORMATION SHEET

It is recommended that you fill out the information on the following page. It will supply vital statistics on your vessel. Make a copy of the data for safe keeping at home.

VESSEL FLOAT PLAN

Formulate the float plan on the following page before departing. Leave it with a responsible person who will notify the United States Coast Guard or local law enforcement authorities if you do not return as planned. If you change your plans be sure to notify this person. Make copies of the float plan and use one each time you go boating. This will help people know where to find you should you not return on schedule. Do not file the float plan with the United States Coast Guard.

NMMA YACHT CERTIFICATION PLATE

At the helm (dash) area you will notice a metal plate which recognizes that your vessel was built to design compliance in effect on the date the certification was verified. The plate also states that your vessel complies with U. S. Coast Guard safety system standards in effect on the date of certification. Vessels 26' and longer are candidates for the NMMA Yacht Certification Plate.





VESSEL INFORMATION

Owner: _____

Address: _____

City & State: _____

Home Phone: _____ Business Phone: _____

In Case Of Emergency Notify: _____

Address _____

City _____ State _____

Phone _____

Insurance Agent's Name: _____

Policy#: _____

USCG Phone: _____ Local Police: _____

Marina Phone: _____ Slip (Dock#): _____

Hull Serial #: RGM _____

Key #: _____ Port Engine: _____ Stbd Engine: _____

Key #: _____ Cabin Door: _____

Selling Dealer: _____

Address: _____

City & State: _____

Phone: _____ Fax: _____

Servicing Dealer: _____

Address: _____

City & State: _____

Phone: _____ Fax: _____

Introduction

VESSEL FLOAT PLAN

Fill out this form before departure. Leave it with a responsible person who will notify the Coast Guard or police if you don't return as planned. If you change your plans be sure to notify this person. Make copies of the float plan and use one each time you go on a trip. This will help people know where to find you should you not return on schedule. Do not file this plan with the Coast Guard.

Owner: _____

Address: _____

City & State: _____

Telephone#: _____

Person Filing Report: _____

Name _____

Telephone _____

Make Of Craft: _____

Length _____ Boat Name _____

Color _____ Trim _____ Hp _____

Inboard _____ Stern Drive _____

Hull I.D.# _____

Documented Vessel # _____

Other Information _____

Persons Aboard:

Name

Age

Address

Phone

_____ See Other Side For Additional Persons

Safety Equipment Aboard: _____

Life Jackets

First Aid Kit

Flares

Flash Light

VHF Radio

Cell Phone ___#_____

Computer ___Desk Top ___Lap Top___

E-mail address _____

Food _____ Water _____

State Registration# _____

Destination:

Leave From _____

Time Left _____

Going To _____

Fuel Capacity _____

Est. Day Of Arrival _____

Est. Time Of Arrival _____

If Not Back By _____ o'clock Call Authorities



VESSEL CRUISE CHECKLIST

- Obtain a current weather update.
- Periodically hoist the boat & inspect the hull bottom and propellers for damage. Marine growth such as barnacles will affect performance and fuel efficiency. Check sacrificial anodes located on the propulsion unit, transom and engine. Replace anode if less than 2/3 remaining.
- Check the electrical system and all safety related equipment. Carry extra fuses. Ensure they are of the proper capacity and type.
- If your boat has been in the water, run the bilge pump until the flow of water stops.
- If your boat has been out of the water, check to see that all bilge water has drained.
- Check that all required safety equipment is on board and in good working condition. Examples include personal flotation devices (PFD's), horn, bell, hand held fire extinguishers, and visual distress signals.
- Check fuel level. Fuel tanks should be filled to slightly less than capacity. Allow for fuel expansion. Remember the "one third rule".
- Open engine compartment. Inspect for fuel odors and visible leaks in the fuel, oil, coolant, exhaust and power steering systems.
- Check the fuel filters for the presence of water .
- Check fluid levels of engines, drives and generator.
- Visually inspect engine for cracked hoses, worn or loose belts, and loose hardware.

Introduction

RECOMMENDED ON BOARD EQUIPMENT

TOOLS

Allen Wrenches
Jack Knife
Phillips Screwdriver
System
Regular & Needle Nose Pliers
Combination Box & End Wrench Set
Screwdriver Set (One With Various Tips)
Side Cutters
Ratchet & Socket Set
Electrical Crimper, Cutter,Stripper Combo
Hammer
VOA Electrical Tester
Water Pump Pliers
Vise Grip Pliers
Floating Flashlight/Lantern
Oil/Fuel Filter Wrench
Tape Rule

BASIC GEAR & SUPPLIES

Tow Line
Mooring Lines
Dock Fenders
Distress Signals
First Aid Kit
Boat Hook
Charts & Plotting Instruments/Back-up Use
Emergency Food & Water
EPIRB
Bailer or Hand Pump
Extra Hand Held Fire Extinguishers
Personal Flotation Devices
Clean Rags, Diapers (For Under Engine-Oil Leaks)
Sunscreen (SPF 30+)
Bucket/Pans w/Lids-Draining/Storing Used Fluids
Mirror (For Inspection & Emergency Signaling)
Funnel

SPARE PARTS

Fuel Filters-Engines & Generator
Poly V- Belt (See Engine Manual)
Coolant For Engine Freshwater
Extra Light Bulbs
Seawater Filter
Fuses
Propeller Set (See Dealer)
Propeller Hardware
Flashlight Batteries
Engine Spare Parts
Generator Spare Parts
Air Filters-Engine & Generator
Oil Filters-Engine, Generator
Drive Oil Filters

BASIC GEAR & SUPPLIES

Lubricating Oil, Liquid Wrench
Duct & Electricians Tape
Coolant (Engine Freshwater Side)
Engine, Drive, Power Steering Oil
Boat Soap (Not Dish Soap)
Woody Wax
Vinyl Cleaner
Hydrogen Peroxide (AC Pans)
Life Raft
Rust Stain Remover (Starbrite)
Corrosion Block
Bilge Cleaner
Nylon Windbreaker Suit
Shop Vac (1 Gal. Cap. Wet-Dry)
Squeegee
Binoculars



Owner's Registration & Systems Checklist

Please note that your boat requires the proper registration by your authorized Regal dealer. To initiate the vessel warranty your dealer must complete the owner's registration form and systems checklist at the time of delivery. The owner must sign the paperwork to acknowledge that the dealer has reviewed the boat systems and warranty provisions with the owner. The owner should keep the original paperwork that features a temporary warranty registration. A warranty certificate will be sent approximately 6 weeks after receipt of the paperwork at Regal World Headquarters.

Dealer's Responsibility

Your vessel has undergone rigid quality assurance inspections before leaving the factory. In addition, your dealer has been trained to perform final pre-delivery checks and to service your Regal boat.

Your dealer's responsibilities include:

1. An orientation in the operation of your Regal boat including matters relating to the safe operation of the vessel.
2. Completion and mailing of your boat registration warranty form to Regal.
3. Location of vendor warranties, registration materials, owner's manual, operation, installation and maintenance instructions for auxiliary equipment supplied with or installed on your Regal boat.

Introduction

Owner's Responsibility

You are entitled to all the benefits and services outlined in your Regal warranty. However, you have certain responsibilities to ensure warranty satisfaction.

These are:

To read the warranty materials and understand them fully.

To examine the vessel in detail at the time of delivery.

Apply the following: boating rules and regulations, safety equipment, environmental regulations, accident reports and warranty regulations terms and conditions.

To read thoroughly all literature supplied with your boat including this owner's manual and to follow the recommendations in the literature.

To provide proper maintenance and periodic servicing of your boat and equipment as set forth in the various manuals supplied.

Customer Service

Take the time to write down your Regal dealer's phone number and E-mail address for future reference. Along with your Regal dealer information is a listing below of other phone numbers and web addresses which may prove useful.

Regal Dealer:

Phone: _____

E-mail: _____

Regal Marine Customer Service:

1-800-US REGAL (1-800-877-3425)

regal@regalboats.com

customer.service@regalboats.com

Volvo Penta Of America (24-Hour Hotline Support):

1-800-522-1959

vpa.consumerrelations@volvo.com



Chapter 1

REGAL MARINE INDUSTRIES, INC. LIMITED WARRANTY

Welcome to the Worldwide Family of Regal Owners! We are very pleased that you have chosen a Regal Powerboat!

This document is your Warranty Registration Certificate and Statement of Warranty. Please check the registration information section for accuracy. If this information is not correct or if you change your address at some future date, please notify us at the following address: Regal Marine Industries, Inc. Attention: Warranty Registrations, 2300 Jetport Drive, Orlando, Florida 32809; or E-mail at customer.service@regalboats.com.

Please read the warranty carefully. It contains important information on Regal's claims procedures and your rights and obligations under this warranty.

WHAT IS COVERED: This Limited Warranty applies only to Regal boats beginning with model year 2008.

LIFETIME LIMITED STRUCTURAL HULL WARRANTY: Regal Marine Industries, Inc. warrants to the original retail purchaser of this boat if purchased from an authorized Regal dealer that the selling dealer or Regal will repair or replace the fiberglass hull if it is found to be structurally defective in material or workmanship for as long as the *original* retail purchaser owns the boat. For purposes of this warranty, the hull is defined as the single fiberglass casting which rests on the water. This limited warranty is subject to all limitations and conditions explained below.

FIVE-YEAR TRANSFERABLE LIMITED STRUCTURAL HULL WARRANTY: In addition to the Lifetime Limited Structural Hull Warranty, Regal offers a Transferable Five-Year Limited Structural Hull Warranty. Under the Five-Year Transferable Limited Structural Hull Warranty, Regal will repair or replace the fiberglass hull if it is found to be structurally defective in material or workmanship within the first (5) years after the date of delivery to the original retail purchaser. Any remaining term of this Five-Year Limited Hull Warranty may be transferred to a second owner if within 60 days of purchase, the new owner registers the transfer with Regal and pays the established warranty transfer fee. Contact Regal Customer Service at the above address for details.

FIVE-YEAR LIMITED HULL BLISTER WARRANTY: Regal warrants that the selling dealer or Regal will repair any underwater gelcoated surfaces of the hull against laminate blisters which occur as a result of defects in material or workmanship within (5) years of the date of delivery, provided that the original factory gelcoat surface has not been altered. Alternation would include but is not limited to damage repair; excessive sanding, scraping, sandblasting; or from improper surface preparation for application of a marine barrier coating or bottom paint, any of which shall void this Five-Year Limited Hull Blister Warranty. Proper preparation must be applied to the hull bottom if the boat is to be moored in the water for periods in excess of sixty (60) days. Regal Marine shall repair or cause to be repaired any covered laminate blisters based on the following prorated schedule.

Less than two (2) years from delivery date - 100%, Two (2) to three (3) years from delivery date - 75%, Three (3) to four (4) years from delivery date - 50%, Four (4) to five (5) years from delivery date - 25%.

Reimbursement shall be limited to one repair, not to exceed one hundred (\$100.00) dollars per foot of boat length prior to prorating. Regal's prior authorization for the method and cost of repair, must be obtained before repairs are commenced. All costs to transport the boat for repairs are the responsibility of the owner.

LIMITED GENERAL WARRANTY: In addition to above hull warranties, Regal warrants to the original purchaser of this boat if purchased from an authorized Regal dealer that the dealer or Regal will repair or replace any parts found to be defective in materials or workmanship for a period of one (1) year from the date of delivery, subject to all exceptions, limitations and conditions contained herein.

LIMITED EXTERIOR FINISH WARRANTY: Regal warrants that the selling dealer or Regal will repair cosmetic defects in the exterior gelcoated finish including cracks or crazing reported to Regal within 90 days from the date of delivery to the original retail purchaser, subject to all limitations and conditions contained herein. All warranty work is to be performed at a Regal dealership or other location authorized by a Regal Customer Service Manager after it is established to Regal's satisfaction that there is a defect in material or workmanship.

REGISTRATION INFORMATION:

CUSTOMER OBLIGATIONS: The following are conditions precedent to the availability of any benefits under these limited warranties:

- (a) The purchaser must sign and the dealer must submit to Regal the "NEW BOAT DELIVERY CHECKLIST" within ten (10) days of the date of delivery and such information must be on file at Regal.
- (b) The purchaser must first notify the dealer from whom the boat was purchased of any claim under this warranty within the applicable warranty period and within a reasonable period of time (not to exceed thirty (30) days) after the defect is or should have been discovered; and
- (2) if such continued use causes other or additional damage to the boat or component parts of the boat.

Introduction

(c) Regal will not be responsible to repair any condition or replace any part, (1) if the use of the boat is continued after the defect is or should have been discovered; and (2) if such continued use causes other or additional damage to the boat or component parts of the boat.

(d) Based on the dealer's knowledge of Regal's warranty policy and/or consultations with Regal, the dealer will accept the claim and arrange for appropriate repairs to be performed, or deny the claim if it is not within the warranty.

(e) The dealer will contact the Regal boat owner regarding instructions for delivery of boat or part for warranty repair if it is covered by the limited warranty.

ALL COSTS TO TRANSPORT THE BOAT FOR REPAIRS ARE THE RESPONSIBILITY OF THE OWNER;

(f) If the Regal boat owner believes a claim has been denied in error or the dealer has performed the warranty work in an unsatisfactory manner, the owner must notify Regal's Customer Service Department in writing at the address listed for further consideration. Regal will then review the claim and take appropriate follow-up action.

WARRANTY EXCEPTIONS: THIS LIMITED WARRANTY does not cover and the following are not warranted:

- (a) Engines, metal plating or finishes, windshield breakage, leakage, fading and deterioration of paints, canvas, vinyl, upholstery and fabrics;
- (b) Gelcoat surfaces including, but not limited to, cracking, crazing, discoloration or blistering except as noted above;
- (c) Accessories and items which were not part of the boat when shipped from the Regal factory, and/or any damage caused thereby;
- (d) Damage caused by misuse, accident, galvanic corrosion, negligence, lack of proper maintenance, or improper trailering;
- (e) Any boat used for racing, or used for rental or commercial purposes;
- (f) Any boat operated contrary to any instructions furnished by Regal, or operated in violation of any federal, state, Coast Guard or other governmental agency laws, rules, or regulations;
- (g) The limited warranty is void if alterations have been made to the boat;
- (h) Transportation of boat or parts to and/or from the REGAL factory or service location;
- (i) Travel time or haul outs, loss of time or inconvenience;
- (j) Any published or announced catalog performance characteristics of speed, fuel and oil consumption, and static or dynamic transportation in the water;
- (k) Any boat that has been re-powered beyond Regal's power recommendations;
- (l) Boats damaged by accident and boats damaged while being loaded onto, transported upon or unloaded from trailers, cradles, or other devices used to place boats in water, remove boats from water or store or transport boats on or over land;
- (m) Water damage to, dry rot to, condensation to, or absorption by interior surfaces, wood structures or polyurethane foam; interior wood including, but not limited to, bleeding and/or discoloration as a result of condensation or moisture or water continually contacting the plywood causing staining to upholstery, carpet or other interior surfaces;
- (n) Costs or charges derived from inconveniences or loss of use, commercial or monetary loss due to time loss, and any other special, incidental or consequential damage of any kind or nature whatsoever.

NO WAIVER OF THESE ITEMS: The terms, conditions, limitations and disclaimers contained herein cannot be waived except by the Customer Service Manager of Regal. Any such waiver must be in writing. Neither the dealer, nor the customer, nor any service, sales and/or warranty representative of Regal is authorized to waive and/or modify these conditions, limitations and/or disclaimers.

GENERAL PROVISIONS:

ALL GENERAL, SPECIAL, INDIRECT, INCIDENTAL AND/OR CONSEQUENTIAL DAMAGES ARE EXCLUDED FROM THIS WARRANTY AND ARE TOTALLY DISCLAIMED BY REGAL. IT IS THE INTEREST OF THE PARTIES THAT THE OWNER'S SOLE AND EXCLUSIVE REMEDY IS THE REPAIR OR REPLACEMENT OF THE VESSEL OR ITS ALLEGEDLY DEFECTIVE COMPONENT PARTS AND THAT NO OTHER LEGAL OR EQUITABLE REMEDIES SHALL BE AVAILABLE TO SAID OWNER. SOME STATES DO NOT ALLOW THE EXCLUSION OF INCIDENTAL OR CONSEQUENTIAL DAMAGES SO THE FOREGOING MAY NOT APPLY TO YOU. THIS IS A LIMITED WARRANTY; REGAL MAKES NO WARRANTY, OTHER THAN CONTAINED HEREIN;

TO THE EXTENT ALLOWED BY LAW ANY WARRANTIES OF MERCHANTABILITY OR FITNESS FOR A PARTICULAR PURPOSE ARISING IN STATE LAW ARE EXPRESSLY EXCLUDED TO THE EXTENT ALLOWED BY LAW. ANY IMPLIED WARRANTY OF MERCHANTABILITY IS LIMITED TO THE PERIOD OF THIS LIMITED WARRANTY. ALL OBLIGATIONS OF REGAL ARE SPECIFICALLY SET FORTH HEREIN. REGAL DOES NOT AUTHORIZE ANY PERSON OR DEALER TO ASSUME ANY LIABILITY IN CONNECTION WITH REGAL BOATS. Some states do not allow limitations on how long an implied warranty lasts, so the above limitation may not apply to you. Regal's obligation with respect to this warranty is limited to making repairs to or replacing the defective parts and no claim for breach of warranty shall be cause for cancellation or rescission of the contract or sale for any boat manufactured by REGAL MARINE INDUSTRIES, INC.

Regal will discharge its obligations under this warranty as rapidly as possible, but cannot guarantee any specific completion date due to the different nature of claims which may be made and services which may be required. Regal reserves the right to change or improve the design of its boats without obligation to modify any boat previously manufactured. This limited warranty gives you specific legal rights, and you may also have other rights which may vary from state to state. Regal shall in no way be responsible for any repairs not PRE-AUTHORIZED by a Regal Customer Service Manager or repairs performed by a repair shop not PRE-AUTHORIZED by a Regal Customer Service Manager.

Safety On Board



Safety awareness can not be over emphasized. Safety on board needs to be the skippers number one priority. In this manual you will find many safety precautions and symbols to identify safety related items. Heed all safety precaution information.

Remember, the skipper is responsible for the safety of his passengers and crew.

SAFETY LABELS

SAFETY PRECAUTION DEFINITION

Safety precautions are stated as caution, warning and danger signal words. They are highlighted in this manual by font design and symbol usage. Also, a *notice* heading is included which provides operation and maintenance information but is not hazard-related. An information label provides tips on a variety of topics. **Become familiar and understand all safety precaution labels!**

	WARNING
Potentially hazardous situation that, if not avoided, could result in death or serious injury.	

	CAUTION
Indicates a potentially hazardous situation or unsafe practice that, if not avoided, may result in injury, property or product damage.	

NOTICE	
General or specific information which is important to correct operation or maintenance, but is not hazard related.	

	DANGER
Immediate hazardous situation that, if not avoided, will result in death or serious injury.	

	INFORMATION
Educational tips for the skipper and crew.	

Safety On Board

PRECAUTIONARY LABELS

Read and understand all safety labels affixed to your Regal boat or found in this manual and the vendor literature. Many of the safety labels are posted close to the helm, aft cockpit, cabin and swim platform. The location of the labels may vary.

Review the helm safety labels with passengers before disembarking.

Use common sense to analyze the result of an action on board your vessel. **Always think safety first!**

NOTICE

DO NOT REMOVE OR COVER
ANY PRECAUTIONARY LABELS.
KEEP HARSH CHEMICALS
AWAY FROM LABELS.
IF A LABEL BECOMES ILLEGIBLE,
CONTACT YOUR REGAL DEALER
FOR ORDERING REPLACEMENTS.

GENERAL BOATING SAFETY

We understand that you are eager to go boating. However, we strongly suggest that you thoroughly familiarize yourself and friends or members of your family with safe boating practices before setting out.

Remember, that along with the freedom and exhilaration of boating comes the responsibility that you have for the safety of your passengers and other boaters who share the water with you.

Boating regulations vary from state to state. Check with your local state and local authorities for the regulations pertaining to your area.

Check with local FM weather stations, U. S. Coast Guard, or on-line for the latest weather conditions. Remember getting caught in severe weather is hazardous. Check weather conditions periodically while you are boating. If you are forced to operate your boat in a storm condition, take common sense precautions; wear PFD's, store gear, reduce speed and if possible head for safe refuge.

It is best to avoid operating your boat in foggy weather. When fog sets in, take bearings, log courses and speeds. You are required to emit a five second blast from your horn or whistle once every minute. Also, have your passengers wear PFD's and observe for oncoming vessels.

Operation in shallow water presents a number of hazards including sand bars and water levels influenced by tides. If the vessel strikes an underwater hazard, check for boat and engine damage. If the engine vibrates excessively after striking an underwater obstruction, it may indicate a damaged propeller. If you run aground, seek help by radio or flares.

Make sure your boat and equipment are in top condition. Do this by frequently inspecting the hull, engine and propulsion components.



Chapter 2

You must provide a Coast Guard approved personal flotation device (PFD) for every person on board. These PFD's should be in good condition and easily accessible.

Insist that non-swimmers and children on board wear a PFD at all times. If you encounter rough weather conditions, make sure everyone on board is wearing a PFD, including yourself. Instruct your passengers in how to put on their PFDs and be sure they know their storage location on the boat. Remember, in an emergency, a PFD that cannot be quickly located and worn is useless.

Never allow anyone to sit anywhere on the boat not specifically designed as seating. While underway, ALWAYS insist passengers sit in a seat and set an example by doing this yourself.



Never drink and drive! As captain, you are responsible for the safety of your passengers. Alcohol and boating can be a dangerous combination. DO NOT mix them. Alcohol impairs the boat operators ability to make conscious decisions and react

to emergency situations quickly.

Never overload your boat! An overloaded boat, or one with uneven weight distribution can be difficult to steer.

CAUTION

READ AND UNDERSTAND THE SEATING ARRANGEMENT DRAWING IN THE TECHNICAL CHAPTER (12-38). THIS DRAWING DISPLAYS THE DESIGNATED SEATING ARRANGEMENT FOR A BALANCED LOAD AND VESSEL MAXIMUM PERSONS CAPACITY.

Use maximum caution when fueling. Never allow any smoke or flame nearby while you are fueling. **ALWAYS** check for fuel leaks and fumes when fueling is finished. **Be**

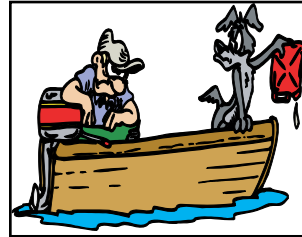

certain there is enough fuel aboard for your cruising needs. Include any reserve that might be needed should you change your plans due to weather or an emergency. **Practice the “one-third rule:** Use one-third of your fuel going out, one-third to return

and retain one- third as a reserve.

Always check the weather before departure. Be particularly cautious of forecasted electrical storms and high winds.

Always have up-to-date charts aboard as a back-up to your plotter and auto pilot option. Charts can be obtained at your closet marina, on-line store or by contacting one of three federal government agencies.

Always file a float plan. Leave details of your trip with someone responsible who will be remaining on shore. Include expected return, plus name and phone number of a contact person in case of emergency.

Use care, courtesy and common sense when launching, docking or operating your boat.

Learn and obey the “Rules of the Road”. A weather resistant placard copy of the “Rules of the Road” is included in the on board Regal information packet. Additional information can be obtained from the U.S. Coast Guard Auxiliary or your local Power Squadron organization. In case of emergency know the international distress signals for your VHF radio. The spoken word “MAYDAY” is the international signal of distress and is for emergency use only. Under no circumstances should this word be used, unless there is danger at hand.

Safety On Board

Posted speed limits, swimming areas, “no wake” zones and other restrictions should be red-flagged. They are so noted for a reason. Sensible boat use, plus courtesy, equals enjoyable and safe boating.

It is your responsibility to stay abreast of all federal, state and local rules, as some laws or regulations may change or be different from state to state. Contact your local boating agencies for updated information.

We can not stress safety enough! Remember, there are no brakes on your boat, and the water current and wind velocity both affect your ability to respond. The operator must use caution at all times to maintain control of his vessel and especially to keep a safe distance from other boats and obstacles.

Always keep all safety gear in optimum condition. Pay special attention to attached tags and plates indicating expiration dates on equipment such as fire extinguishers, and personal flotation devices. Encourage a periodic maintenance check on all safety equipment. Contact your Regal dealer or marine professional for more information. Again, remember that the captain is responsible for his crew, passengers and vessel.

REQUIRED SAFETY EQUIPMENT

PERSONAL FLOTATION DEVICES



All personal flotation devices (PFD's) must be Coast Guard approved, in good working condition, and must be the correct size for the wearer. All PFD's must be readily accessible. This means being able to wear them in a reasonable amount of time in case of an emergency (fire, boat sinking, etc.). They should not be stored or locked in closed areas. Also, make sure that all coverings are removed such as plastic from any PFD's. Devices such as a ring buoy need to be available for immediate deployment. A PFD should be worn at all times when your boat is operating on the water. A PFD may save your life.

As a minimum U. S. Coast Guard requirement all recreational boats must carry one type I, II, III, or V PFD (wearable) for each person aboard. See the explanation following for each type. For type V to be counted they must be used according to the label instructions. **In addition, all boats over 16' must carry one Type IV (throwable) PFD.**

Some states require that PFD's be worn by children of specific ages at all times. Check with local and state boating agencies for particular requirements in your state before taking children on the water. Child life jackets are classified by the child's weight and should like all life jackets be sized before being purchased.

Remember PFD's will not necessarily keep you from drowning, even though they are designed to keep a person from sinking. When purchasing PFD's make sure it safely fits the person wearing it. It is a good idea to test PFD's in a life-guarded shallow pool before venturing on the water.



Chapter 2

Refer to the USCG minimum equipment requirements at the end of this chapter. It is meant to be a guide only. Contact state and local agencies for additional equipment requirements. Remember as the captain of your vessel you are responsible for its safe operation.



TYPE I- Also known as an off-shore jacket, it provides the most buoyancy. It is a PFD for all waters and is especially useful in rough waters where rescue may encompass additional time. It is designed to turn most unconscious

users in the water to a true face-up position. Type I PFD is available in adult & child sizes. Buoyancy minimum poundages are 15.5 adult, 11 medium child, and 7 for small child and infants.

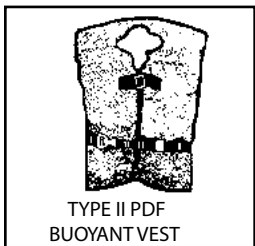

TYPE II PFD
BUOYANT VEST

TYPE II- Also known as near-shore buoyant vest, it is recommended for calm, inland water where rescue time will be minimal. It will turn some unconscious people face-up in the water but not as numerous as Type I. They use the same buoyancy

minimum poundages as the type I PFD's.

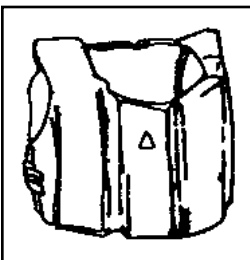

TYPE III- Known as a flotation aid it is good for calm, inland water or where there is a chance for quick rescue. It is designed so wearers can place themselves in a face-up position in the water. The wearer may have to tilt their head back to avoid face-down positions.

Type III offer the same buoyancy minimum poundages as the Type II. They are generally the most comfortable for continuous wear. Float coats, fishing vests, and vests featuring designs for various sport activities are examples of Type III.

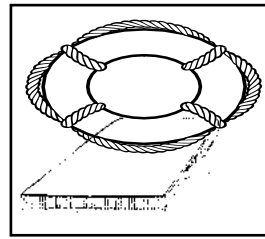

TYPE IV- Intended for calm, inland water with heavy vessel traffic, where help is constantly present. It is designed to be thrown into the water for someone to grab on to and held until rescued. It is not designed to be worn. Type IV includes ring buoys, buoyant cushions, and horseshoe buoys.

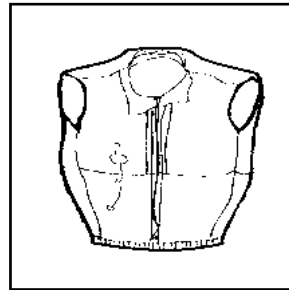

TYPE V- Also known as a special use device this is the least bulky of all PFD's. It contains a small amount of inherent buoyancy, and an inflatable chamber. It is rated even to a Type I, II, or III PFD (as noted on the jacket label) when inflated. Some Type V devices provide significant hypothermia protection. Varieties include deck suits, work vests, board sailing vests and Hybrid PFD's. Remember that this Type V type PFD may be carried instead of another PFD **only if used according to the approval condition on the label.**

Note: A water skier or wakeboarder is considered on board the vessel and a PFD is required for the purposes of compliance with the PFD carriage requirements. It is advisable and recommended for a skier or wakeboarder to wear a PFD designed to withstand the impact of hitting the water at a high speed. "Impact Class" marking on the label refers to PFD strength, not personal protection. Some state laws require a skier or wakeboarder to wear a PFD.

Safety On Board

PFD'S FOR PETS

If you are a skipper who needs to have his pet dog or cat on board or dock side then a PFD is recommended. The PFD will aid you in finding the pet if it should fall overboard. The device must fit the pet properly. Also, it may take a bit of training before the pet is comfortable wearing the PFD. Normally, dogs are easier to train wearing a life vest than a cat.

Marine type retail stores will fit a pet to a PFD by body weight.

MAINTAINING YOUR PFD'S

A PFD is only useful if it is well maintained. Always be aware of PFD age since it has a life expectancy like any other piece of equipment.

✓ Check periodically for broken zippers, frayed webbing, water soaked kapok bags, missing straps, and sewing that has become undone.

✓ Clean each PFD with mild soap and water only. Again, let dry sufficiently before storing.

✓ Keep PFD's out of grease and oil since they can deteriorate the jacket inner and outer materials.

✓ Check any kapok-bagged jackets by squeezing. If you hear air escaping the bag is defective and the PFD should be thrown away.

✓ Grab the cover with the fingers. If the cover material rips, the PFD is rotted and should be thrown away.

✓ If the kapok bag is hard the PFD should be discarded.

FIRE EXTINGUISHERS

GENERAL INFORMATION

Fire extinguishers are classified by a letter and numeric symbol. The letter references the type of fire the unit is designed to extinguish.

For example, type B extinguishers commonly used on boats are designed to put out flammable liquids such as grease, oil and gasoline.

The number indicates the general size of the extinguisher (minimum extinguishing agent weight).

Coast Guard Approved extinguishers are identified by the following marking on the label:

“Marine Type USCG Approved, Size..., Type..., 162.028/.../”, etc.

FIRE EXTINGUISHER CONTENTS				
CLASS	FOAM IN GALS.	CO2 IN LBS.	DRY CHEM IN LBS.	HALON IN LBS.
B-I	1.25	4	2	2.5
B-II	2.5	15	10	10

MINIMUM PORTABLE FIRE EXTINGUISHERS REQUIRED		
VESSEL LENGTH	NO FIXED SYSTEM	WITH FIXED SYSTEM

LESS THAN 26'	1 B-1	0
26' TO LESS THAN 40'	2 B-1 OR 1 B-II	1 B-1
40' TO 65'	3 B-1 OR 1 B-1 & 1 B-II	2 B-1 OR 1 B-2



U. S. Coast Guard approved fire extinguishers are required on all Regal boats. Besides the minimum Coast Guard requirements always check state and local agencies for additional requirements and equipment.

Coast Guard approved extinguishers are hand-portable, either B-I or B-II classification. U. S. Coast Guard approved hand-portable and semi-portable extinguishers contain a metal plate that shows the manufacturers name and extinguisher type, capacity and operating instructions. They have a special marine type mounting bracket which keeps the extinguisher solidly mounted until needed. The extinguisher needs to be mounted in a readily accessible location but one that will not be bumped by people while underway. All approved extinguishers shall have an indication gauge.

U.S.C.G APPROVED FIRE EXTINGUISHER TYPES & FEATURES



■ The dry chemical agent is widely used because of its convenience and low cost. The extinguisher canister is filled with a white dry chemical powder along with a pressurized gas. It is a good idea to shake this type periodically because they tend to “pack” on the canister bottom.



leaves a messy residue. Do not use this extinguisher for electric fires.

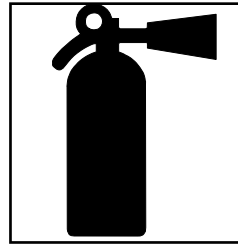

■ The carbon dioxide unit uses CO₂ gas under high pressure, with a funnel discharge hose usually swivel mounted. This extinguisher leaves no residue and does not cause interior engine harm. To ensure workability, weigh the unit annually. A 10% maximum weight variance is

allowed.

Another type of liquified gas used today is FE-241. This gas is colorless and odorless, heavier than air and sinks to the lower bilge to extinguish fires. Since the year 2000 ingredients have changed to a more environmental friendly formula (Chlorotetrafluoroethane or FE-241). FE-241 is used in portable-hand units along with making up the majority of boat automatic fire extinguishing systems. The canister needs to be weighed once a year. These clean agent units feature a dash mount indicator.

Refer to the information regarding fire prevention in this manual.

VISUAL DISTRESS SIGNALS

All vessels used on coastal waters, any of the Great Lakes, territorial seas, and those waters connected directly to them up to a point where a body of water is less than two miles wide, must be equipped with Coast Guard approved visual distress signals.

Vessels owned in the United States operating on the high seas must be equipped with U.S.C.G. approved visual distress signals.

Safety On Board

VISUAL DISTRESS SIGNALS

PYROTECHNIC DEVICES

Pyrotechnic visual distress signals must be Coast Guard approved, be ready for service and must be readily accessible. They all display a marking which is the service life, which must not have expired. A minimum of 3 devices are required for the day and 3 devices for night.

Some devices meet both day and night requirements. Pyrotechnic devices should be stored in a cool, dry location. Most of these devices can be purchased in an highly visible (orange) watertight container. Types of Coast Guard approved pyrotechnic distress signals and associated devices are:

- Pyrotechnic red flares, hand-held or aerial type.
- Pyrotechnic orange smoke, hand-held or floating type.
- Launchers for parachute flares or aerial red meteors.

All in all, each distress signal has certain advantages and disadvantages.

There is no distress signal that is best under all situations.

Pyrotechnics are recognized world-wide as superior distress signals. A downfall is they emit a very hot flame that can cause burns and or ignite flammable materials. Pistol launched and hand-held parachute flares operate consistent with firearms and therefore must be carefully handled. Check with local and state regulations since some of these device are considered firearms and are prohibited. It is best to carry red aerial flares which are visible from a greater distance. Also, the red parachute flares burn for longer periods and therefore are more likely to be seen by another vessel.

Non-pyrotechnic devices must all be in serviceable con-

NON-PYROTECHNIC DEVICES

dition, readily accessible, and must be certified by the manufacturer to comply with U.S.C.G standards. They include:

- Orange distress flag.
- Electric distress light.

The distress flag is for day use only. It must be 3 x 3 or larger with a black square and ball on an orange background. It can be spotted when attached to a boat hook, long fishing rod, or paddle with the person waving the flag back and forth overhead.

The electric distress light is for night use only flashing the international SOS distress signal (... _ _ _ ...).

Under Inland Navigation Rules, a high intensity white light that flashes at regular intervals from 50-70 times per minute is considered a distress signal.

Remember that regulations prohibit the display of visual distress signals on the water under any circumstances except when assistance is required to prevent immediate or potential danger to passengers on a vessel.



INTERNATIONAL DISTRESS SIGNALS

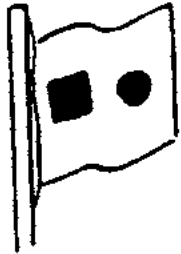

BLACK SQUARE
AND BALL ON
ORANGE BACKGROUND



CODE FLAGS
NOVEMBER
& CHARLIE



SQUARE FLAG
& BALL



PERSON
WAVING
HANDS

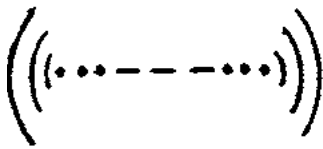

MORSE
CODE S.O.S.



"MAYDAY"
BY
RADIO

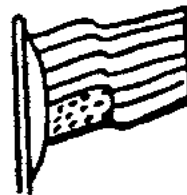

ENSIGN
UPSIDE
DOWN



PARACHUTE
RED FLARE



RED METEOR
FLARES



SMOKE



FOG HORN
SOUNDED
CONTINUOUSLY



GUN FIRED AT
1- MINUTE
INTERVALS

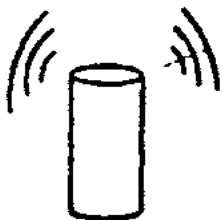

POSITION
INDICATING
RADIO BEACON



DYE MARKER
(ANY COLOR)



HAND-HELD
FLARE

Safety On Board

SOUND PRODUCING DEVICES

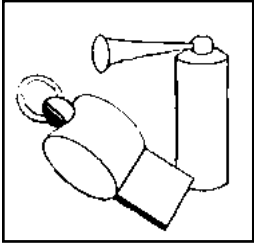

According to both Inland and International Rules, all boats **must** carry a way of producing an efficient sound signal. If your vessel is 12 meters (39' 4") or longer, a power whistle or power horn and bell must be carried. Bell mouth must be at least 7 7/8"

diameter.

The sound signal made in all cases must be capable of a four or six second blast audible for one half mile. See the section discussing bridge and whistle signals for more information.

RADIO COMMUNICATIONS

VHF radios are used for distress and ship to shore and ship to ship communications today. Learn the specialized messages such as **Mayday, Mayday, Mayday**. It is only used when life or vessel is in imminent danger.

Many of the more recent VHF's feature DSC capability which offers the ability to place and receive digital calls directly with vessels and shore stations including USA and Canadian Coast Guards. Channel 70 is reserved exclusively for DSC calls. Refer to the VHF owner's information since you need to establish a Mobile Maritime Safety Identity (MMSI) number before using the DSC feature. A MMSI number identifies each DSC radio, like a telephone number. The FCC requires a ship station license for all vessels equipped with a marine VHF radio.

NAVIGATION LIGHTS

The U. S. Coast Guard requires recreational boats operating at night to display navigation lights between sunset and sunrise along with other periods of reduced visibility.

Navigation lights help avoid collisions by improving the night visibility of vessels. Red and green directional lights, white stern lights, white masthead lights and white all-around lights must be displayed in specified positions, depending on boat size, and mode of operation.

The configuration of visible lights tells an operator the size, direction of travel and means of propulsion (sail, power, rowing or at anchor) of another vessel.

This helps both operators determine who has the right of way. Larger boats are required to carry bigger, brighter lights that are visible over longer distances. See the light requirement chart for pleasure craft.

MARINE SANITATION DEVICES

Recreational vessels under 65' with installed toilet facilities must have an operable marine sanitation device (MSD) on board. Vessels 65' and under may use Type I, II, or III MSD's. All installed MSD's must be U.S. Coast Guard certified. The MSD's are labeled to show conformity to the regulations.

NAVIGATION RULES

The navigation rules establish actions to be taken by vessels to avoid collision. They are divided into Inland/International. *Operators of vessels 39.4' or more shall have on board and maintain a copy of the Inland navigation rules.*



NAVIGATION LIGHT RULES

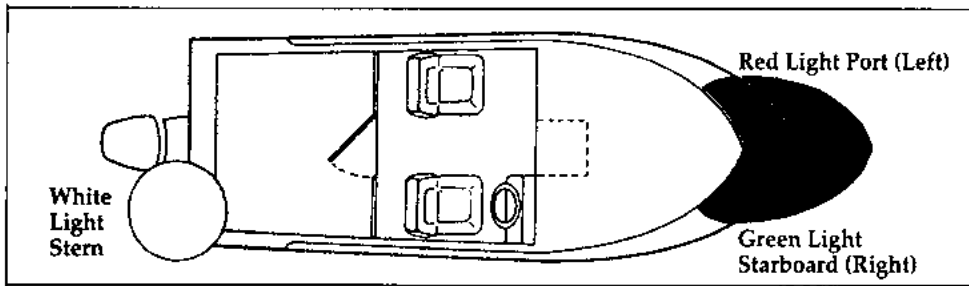

Location of lights on vessel	Visible Range		Degrees of arc lights
	Less than 12 m.	12 m. but less than 20 m.	
Masthead	2	3	225°
All-round	2	2	360°
Side lights	1	2	112.5° each color
Stern light	2	2	135°

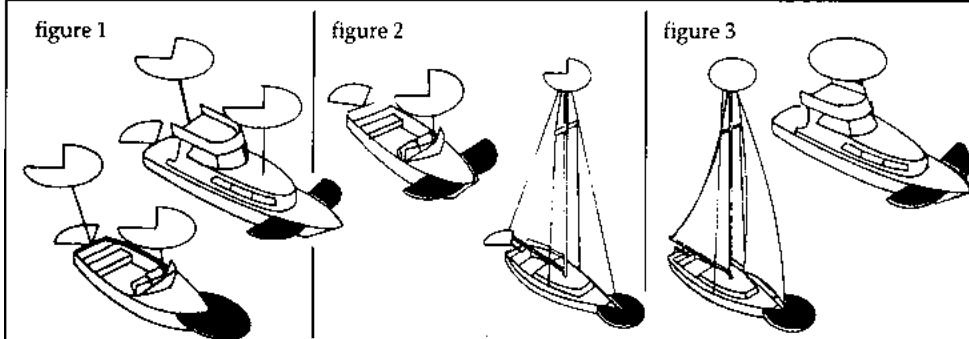

Boats less than 12 meters in length

Motorboats or sailboats using power: The lighting arrangements to figure 1, 2 or 3 may be used.

Sailboat using sails alone: The lighting arrangements in figure 4, 5 or 6 may be used.

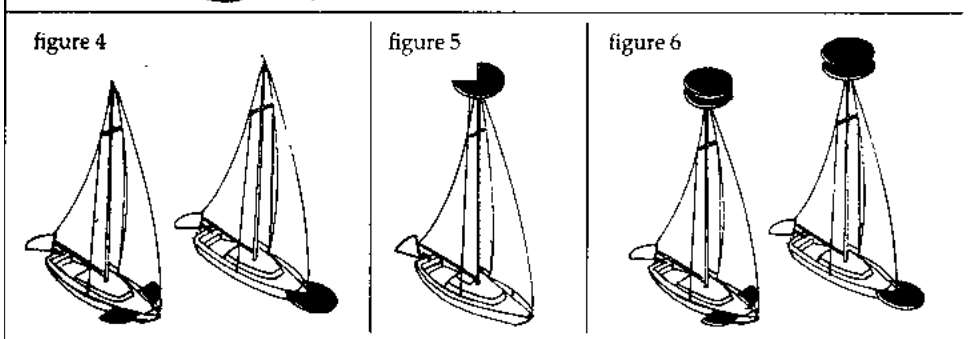

Boats 12 meters but less than 20 meters in length

Motorboats or sailboats using power: The lighting arrangements to figure 1 or 2 may be used.

Sailboat using sails alone: The lighting arrangements in figure 4, 5 or 6 may be used.

Location of lights

Lights should be located as shown in the drawings.

The masthead light (forward white light in figures 1, 2 and 7d) must be at least one meter higher than the colored lights on a boat less than 12 meters in length and at least 2.5 meters above the gunwale on a boat 12 meters but less than 20 meters in length.

Exceptions

Motorboat or sailboat using power, built before December 24, 1980: The lighting arrangement in figure 1, 2 or 3 may be used. However, the arrangement in figure 3 is not acceptable on a boat that is 12 meters or longer on international waters.

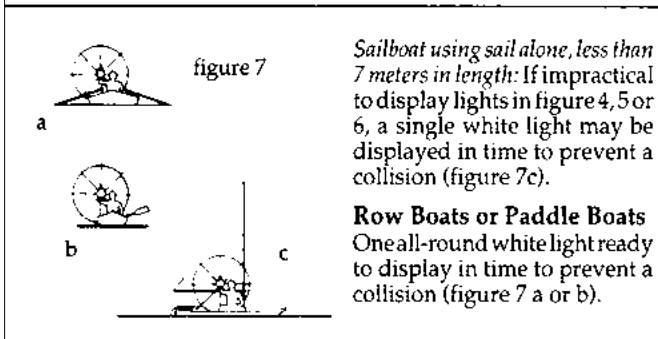

Sailboat using sail alone, less than 7 meters in length: If impractical to display lights in figure 4, 5 or 6, a single white light may be displayed in time to prevent a collision (figure 7c).

Row Boats or Paddle Boats
One all-round white light ready to display in time to prevent a collision (figure 7 a or b).

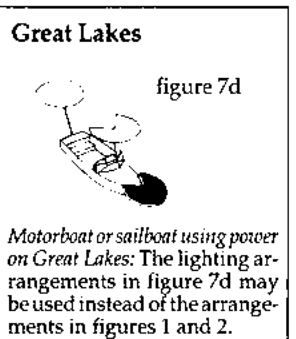

Great Lakes

Motorboat or sailboat using power on Great Lakes: The lighting arrangements in figure 7d may be used instead of the arrangements in figures 1 and 2.

POLLUTION REGULATIONS

NOTICE

DISCHARGE OF OIL PROHIBITED

THE FEDERAL WATER POLLUTION CONTROL ACT PROHIBITS THE DISCHARGE OF OIL OR OILY WASTE INTO OR UPON THE NAVIGABLE WATERS AND CONTIGUOUS ZONE OF THE UNITED STATES IF SUCH DISCHARGE CAUSES A FILM OR SHEEN UPON, OR DISCOLORATION OF THE SURFACE OF THE WATER, OR CAUSES A SLUDGE OR EMULSION BENEATH THE SURFACE OF THE WATER.

**VIOLATORS ARE SUBJECT TO
A PENALTY OF \$5,000**

MARPOL TREATY

The USCG now enforces the International Convention for the Prevention of Pollution from ships, referred to commonly as the MARPOL TREATY (marine pollution). This international treaty prohibits the overboard dumping of all oil, garbage, ship-generated plastic and chemicals. There is a placard on board your boat (typical example shown below) that explains the garbage and plastic dumping laws in detail.

Immediately notify the USCG if your vessel discharges oil or hazardous substances in the water. Call toll free 1-800-424-8802. Report the following information: location, source, size, color, substances and time observed.

No vessel may intentionally drain oil or oily waste from any source into the bilge of any vessel. A bucket or bailer is suitable as a portable means of discharging oily waste. The placard noted above is normally located in the engine or may be attached to the engine hatch.



GARBAGE DISCHARGE

The act to prevent pollution from ships places limitations on the discharge of garbage from vessels. It is illegal to dump **plastic trash** anywhere in the ocean or navigable waters of the United States. Also, it is illegal to discharge **garbage** in the navigable waters of the United States, including the Great Lakes. The discharge of other types of garbage is allowed outside certain specified distances from shore as determined by the nature of that garbage. United States vessels of 26 feet or longer must display in a prominent location, a durable placard at least 4" x 9" notifying crew and passengers of discharge restrictions. USA vessels of 26' or longer equipped with a galley and berthing must have a written Management Plan describing the plan for collecting, processing, storing and discharging garbage, and designate the person charged with carrying out the plan.

The placard noted below is usually found under the galley or the cockpit refreshment center.

THE DISCHARGE OF PLASTIC OR GARBAGE WITH PLASTIC INTO ANY WATERS IS PROHIBITED . THE DISCHARGE OF ALL GARBAGE IS PROHIBITED IN THE NAVIGABLE WATERS OF THE UNITED STATES AND IN ALL OTHER WATERS, WITHIN THREE NAUTICAL MILES OF THE NEAREST LAND.		
THE DISCHARGE OF DUNNAGE, LINING, AND PACKING MATERIALS THAT FLOAT IS PROHIBITED WITHIN 25 NAUTICAL MILES FROM THE NEAREST LAND.	OTHER UNGROUND GARBAGE MAY BE DISCHARGED BEYOND 12 NAUTICAL MILES FROM THE NEAREST LAND.	OTHER GARBAGE GROUND TO LESS THAN ONE INCH MAY BE DISCHARGED BEYOND THREE NAUTICAL MILES FROM THE NEAREST LAND.
A PERSON WHO VIOLATES THE ABOVE REQUIREMENTS IS LIABLE FOR A CIVIL PENALTY OF UP TO \$25,000, A FINE OF UP TO \$50,000, AND IMPRISONMENT FOR UP TO FIVE YEARS FOR EACH VIOLATION, REGIONAL, STATE, AND LOCAL RESTRICTIONS ON GARBAGE DISCHARGES MAY ALSO APPLY.		

Safety On Board

LIFE RAFTS

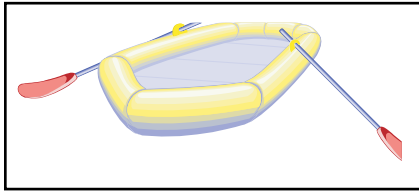

Inflatable life rafts are recommended for ocean going and vessels operating in a large body of water like the Great Lakes.

They provide a shelter for extended periods. If used, make sure it is large enough for all aboard and contains the proper emergency equipment pack. Also, periodically have the unit professionally serviced. Make sure the life raft is Coast Guard approved since it would require meeting a number of stringent material and performance standards.

USCG MINIMUM EQUIPMENT REQUIREMENTS

Use the chart below as a guideline for assuring your vessel is outfitted to meet USCG standards. Remember to check with local and state authorities for additional equipment requirements. Make sure your vessel certificate of numbers are on the boat, updated and displayed properly according to state requirements. Keep the paperwork on board in a watertight and safe environment. Make sure it is quickly accessible.

On documented vessels keep both the original and current certificate on board stored in a safe, dry, and accessible location. Also, on documented vessels make sure the vessel name/hailing port are marked on the hull exterior with letters not less than 4" in height. In addition, the Official Number must be permanently affixed on a clearly visible interior structure part of the boat-block type Arabic numbers not less than 3" in height.

USCG Minimum Equipment Requirements for Recreational Vessels					
Boat Size in Feet	16'	26'	40'	65'	165'
Personal Flotation Devices ¹	One Type I, II, III, or V per person		One Type I, II, III, or V per person plus one Type IV throwable		
Fire Extinguishers ²	One B-I, any type		One B-II or Two B-I	One B-II and one B-I, or three B-I	One or more B-II (vessels 0-50 tons gross) Two or more B-II (vessels 50-100 tons gross)
No Fixed System			One B-I	Two B-I or one Class B-II	
With Fixed System	No Portables Required				
Visual Distress Signals	Night signals required when operating at night		Minimum of three day-use and three night-use (or three day/night combination) pyrotechnic devices ⁵		
Sound Producing Devices	Horn or whistle recommended to signal intentions or signal position		One bell, and one whistle or horn required to signal intentions or position		
Backfire Flame Arrestor	One CG-approved device on each carburetor of all gasoline-powered engines built after April 1940, except outboard motors				
Ventilation	CG standard system required on gasoline powered vessels with enclosed engine compartments built after August 1980				
Navigation Lights					
Under Power ^{3,4}	Sidelights, Stern Light and Masthead ^{6,7}				
Under Sail	Sidelights and Stern Light ^{5,8}				
Rowing	Same as "Under Sail"				
At Anchor	All-round light, 2nm (at night) or black anchoring ball (during the day) when outside a designated anchorage				
Visibility Range	1nm Sidelights, 2nm all others		3nm Masthead, 2nm all others		5nm Masthead, 2nm all others
Pollution Regulations	"Honor system" (no plaques required)		5" x 8" Oil Discharge placard and 4" x 9" Waste Discharge placard		
Marine Sanitation Devices	CG-certified Type I, II or III Marine Sanitation Device (MSD). Subject to local laws!		Vessels over 40' with a galley must have a Waste Management Plan		Type II or III MSD only
Navigation Rules	Familiarity with the Inland Navigation Rules required		The Inland Navigation Rules ("Rules of the Road") must be kept on board		

<ol style="list-style-type: none"> 1. <i>Pfd's must be CG approved, wearable by the intended user and readily accessible.</i> 2. <i>Fire extinguishers required on boats with enclosed engine compartments (not outboards), enclosed living spaces or permanent fuel tanks.</i> 3. <i>Sailboats operating under engine power are considered power driven and must follow the "Under Power" rules. During the day, motorsailing vessels are required to fly a motoring cone.</i> 4. <i>Power-driven vessels under 23' and under 7 knots can substitute a white lantern or torch in place of the required lights.</i> 	<ol style="list-style-type: none"> 5. <i>Non-pyrotechnic substitutes: 1 orange distress flag (day-use) and 1 electric SOS signal light (night-use).</i> 6. <i>All boats under 65' can substitute a single bi-color light for sidelights.</i> 7. <i>Boats under power under 40' can substitute a single all-round light for separate stern and masthead lights.</i> 8. <i>Boats under sail under 40' can substitute a tri-color light for separate sidelights and stern light.</i>
---	---

Additions to these requirements are prescribed by some individual state laws. Check your state's Boating Safety Handbook for a complete list.



EXHAUST & CARBON MONOXIDE

Carbon monoxide (CO) in exhaust can be hazardous, especially from gasoline engines, gasoline generators, grills, stoves, space heaters and on a much smaller degree diesel engines.

CO is a natural by-product of the gasoline engine using an artificial spark. Diesels on the other hand detonate fuel using pressure and temperature. Looking at the two engines another way, gasoline engines use much more oxygen up in the combustion process which contributes to a much higher CO build-up. Although diesels do produce a small amount of CO the combustion process operates with much greater amounts of oxygen which the end result is a much lower CO level.

Ensure that you read the information and follow all the recommendations regarding CO.

Familiarize your crew, passengers and yourself with the sources, symptoms and possible effects of carbon monoxide poisoning. Remember that boats in the same general vicinity can cause your vessel to accumulate dangerous CO levels in the cabin and or in the cockpit.

For safety sake avoid the following:

1. Do not park by other boats with their engine idling or generator cycling for an extended period of time .
2. Do not disable the carbon monoxide alarms that come with your Regal boat. Test the units in accordance with the alarm manufacturers instructions.
3. Do not operate an engine for extended periods of time while in a confined area or where exhaust outlets face a sea wall or bulkhead.
4. Do not operate the engine for an extended period of time with the canvas in the upright and installed position.
5. Have the engine exhaust system inspected when the boat is in for service.
6. Persons sleeping can easily be overcome by carbon monoxide without realizing it. Do not sleep on board while an engine or generator is running close-by.
7. Do not operate your vessel for extended periods with the bow up in slow cruise conditions especially close behind a vessel being towed or one operating at slow speeds.
8. When underway open all hatches, windshield vents, and main cabin entry door to allow proper airflow from bow to stern.

	WARNING
AVOID SERIOUS INJURY OR DEATH FROM CO POISONING! DO NOT OPERATE THE BOAT WITH PEOPLE HOLDING ON TO THE SWIM PLATFORM OR WITH PEOPLE IN THE WATER.	

Safety On Board

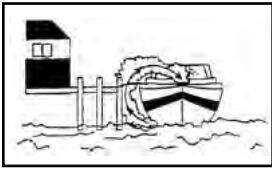

Blockage of exhaust outlets can cause carbon monoxide to accumulate in the cabin and cockpit area even when the hatches, windows, portholes and doors are open. Sea walls and other confined spaces can cause CO levels to be dangerously elevated.

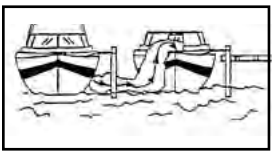

Exhaust from another vessel alongside your boat, while docked or anchored, can emit poisonous CO gas inside the cabin and cockpit areas of your boat.

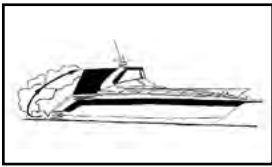

The “station wagon effect” or back-drafting can cause CO gas to accumulate inside the cabin, cockpit/hardtop or bridge areas when the boat is under-way, using protective weather coverings (canvas), high bow angle, improper or heavy loading, slow speeds, or at rest. This can occur when traveling behind another boat.

How does CO affect us?

In high concentrations, CO can be fatal in minutes. However, the effects of lower concentrations over a extended period of time can be just as lethal.

Our blood uses hemoglobin to carry the oxygen we breathe to different body parts. Unfortunately, hemoglobin carries CO more readily than it does oxygen. The result is when we breathe in CO it replaces oxygen in our blood and we begin to suffocate. Also, when we are removed from the CO source it remains in our blood for hours causing long term effects. People have been known to become sick and even lose consciousness hours after exposure.

Carbon monoxide accumulation requires immediate attention! Thoroughly ventilate cabin and cockpit areas. Determine the probable source of the carbon monoxide and correct the condition immediately. Anyone with symptoms of CO poisoning should be placed in a fresh air environment and medical attention found immediately. Regal has installed CO detectors on your boat. Have these detectors professionally calibrated at regular intervals according to the equipment manufacturer’s recommendations.

A Few Notes About Diesel/CO Poisoning

The diesel engine under normal combustion produces much smaller amounts of CO. Therefore, it is far less likely to be fatal to a healthy person. Other factors including weather, temperature and engine condition can greatly affect the unsafe build-up of CO. The **best** approach is to respect and treat the engine, generator and other vessel components the same way you would a gasoline propulsion system giving particular attention to the sources and possible effects of CO poisoning!

Diesel exhaust in the combustion process produces various components and the captain must be aware that the build-up of these select components over a period of time can cause CO or seasickness like symptoms.

These include carbon dioxide, carbon monoxide (CO), nitrogen dioxide, nitric oxide, sulfur dioxide and others.

A healthy person breathing in sulfur dioxide over a period of time through a diesel engine or generator exhaust can develop nausea. This condition is not life threatening but the person may exhibit CO poisoning or seasickness symptoms. Just never rule out that it could be CO poisoning! Immediately find the source of the problem and move the individual to a fresh air environment!



Symptoms of excessive exposure to carbon monoxide (CO) are:

- Dizziness
- Drowsiness
- Nausea
- Headache
- Ringing in the ears
- Throbbing temples
- Watering, itchy eyes
- Flushed appearance
- Inattentiveness
- Incoherence
- Fatigue or vomiting
- Convulsions

WARNING

INSPECT THE EXHAUST SYSTEM. IMMEDIATELY REPAIR OR REPLACE LEAKING, CRACKED AND CORRODED, OR MISSING EXHAUST COMPONENTS.

- Before each trip inspect engine and generator.
- Make sure all exhaust hose clamps are in place and secure.
- Look for exhaust leaking from the exhaust system components, indicated by rust and or black streaking, water leaks, or corroded or cracked fittings.
- Inspect all rubber exhaust hoses for burned or cracked areas. All rubber hoses should feel soft and be free of kinks.
- Visually verify that water exits at the engine exhaust outlet.
- Keep an ear tuned for any change in exhaust sound that could indicate an exhaust component malfunction.

DO NOT OPERATE THE VESSEL IF ANY OF THE ABOVE CONDITIONS EXIST. CONTACT A MARINE PROFESSIONAL!

DANGER

CARBON MONOXIDE IS A TASTELESS, ODORLESS AND INVISIBLE GAS THAT CAN CAUSE DISCOMFORT, SEVERE ILLNESS, AND EVEN DEATH. EXERCISE CAUTION WHILE OPERATING GENERATOR OR ENGINES IN CONFINED SPACES OR AT DOCKSIDE. DO NOT ALLOW HULL EXHAUST OUTLETS TO BECOME BLOCKED OR EXHAUST FUMES CAN BECOME TRAPPED IN AND AROUND THE CONFINES OF YOUR BOAT. DURING IDLE AND SLOW CRUISE CONDITIONS, BILGE BLOWERS SHOULD BE USED.

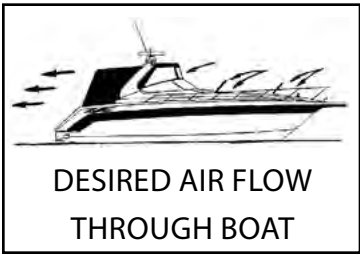

To help prevent carbon monoxide accumulation, ventilate your cabin and cockpit while underway. Open a forward hatch, porthole or window to allow air to travel through the boat's interior and

cockpit. See the illustration for desired airflow.
NOTE: Never occupy moored boat with engines running and/or canvas completely covering vessel.

NOTICE

CARBON MONOXIDE PRECAUTIONARY LABELS ARE LOCATED AT THE HELM, TRANSOM AND CABIN. ENSURE THAT ALL ABOARD READ AND UNDERSTAND THE SIGNS AND EFFECTS OF CARBON MONOXIDE (CO).

Safety On Board

CARBON MONOXIDE DETECTORS

Your Regal boat features designated sleeping accommodations along with galley sink and head compartments. Working CO detectors must be utilized. They are standard equipment on your Regal boat. Mooring by boats running gasoline generators along with vessels using gas cooking/grilling/heating devices could lead to dangerous levels of carbon monoxide on your boat. Always be aware of other vessels mooring close to you especially if you are staying on board overnight. Read the owner's manual and vendor information regarding the CO detectors installed on your vessel.

Follow the periodical service recommendations per the vendor regarding re-calibration of the carbon monoxide detector.

Never attempt to repair a CO detector yourself.

Get to know the signs of carbon monoxide poisoning.

Remember that carbon monoxide (CO) is known as the silent killer.

At Least Annually

To be performed by a marine professional:

- ☑ Replace exhaust hoses or mufflers if any evidence of cracking, charring or deterioration is found.
- ☑ Replace the engine water pump impeller along with the plate and housing if necessary. This will help prevent cooling system and exhaust system overheating.
- ☑ Inspect each of the metallic exhaust components for cracking, rusting, leaking or looseness. Pay detailed attention to the exhaust manifold, cylinder head, water injection elbows.



BOATING & ALCOHOL



FEDERAL LAWS PROHIBIT OPERATING A VESSEL UNDER THE INFLUENCE OF ALCOHOL OR DRUGS. THESE LAWS ARE VIGOROUSLY ENFORCED BY ALL ENFORCEMENT AGENCIES.



Operating a vessel while intoxicated became a specific federal offense effective in 1988. The ruling set federal standards for determining when an individual is intoxicated. If the blood alcohol content (BAC) is

.10% (.08 in some states) or higher for operators of recreational vessels being used only for pleasure are subject to a civil penalty up to \$1,000 or criminal penalty up to \$5,000, one year imprisonment or both. In some states the fines and imprisonment may increase significantly.

The effects of alcohol and drugs account for the highest single cause of marine accidents and deaths. Most deaths in boating accidents occur when someone falls into the water. Balance is one of the first things you lose when drinking alcohol or under the influence of drugs. The problem arises out of not knowing your balance is restricted.

Overall vision is reduced by alcohol especially at night, along with double or blurred vision. Peripheral vision is lessened which restricts seeing vessels or objects on the side. Also, color awareness decreases especially with red and green which happen to be the colors of boat navigation lights, buoys, and channel markers.

Alcohol will greatly increase your heat loss so it increases the effects of hypothermia. Finally, your ability to make correct judgements in emergency situations is greatly reduced. Alcohol takes away the brains ability to process information quickly and delays a persons reaction time.

Don't drink and drive!

ALCOHOL MYTHS AND FACTS

Myth: Beer is less intoxicating than other alcoholic beverages.

Fact: One 12 oz. can of beer has about the same amount of alcohol as a 5oz. glass of wine or a shot of liquor.

Myth: Black coffee, fresh air, and a shower will sober the effects of alcohol.

Fact: After consuming alcohol time is the only thing that will sober you up. Our bodies average burning 1 oz. of alcohol every hour. If a person is drunk, it will take a person seven or more hours to sober up.

Myth: Telling if a person is too drunk to operate a vessel is easy.

Fact: Many experienced drinkers have learned to compensate for the visual effects of alcohol and can disguise their drunk condition.

Myth: You can judge if you are fit to operate a boat.

Fact: Judgement is one of the first elements you lose when drinking.

Safety On Board

BOATING ACCIDENTS

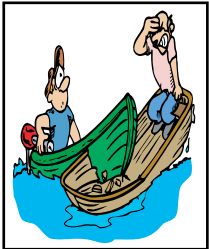

The following is a list of common causes of boating accidents. Be aware of them and take the necessary steps to ensure that yourself and crew are educated and prepared to act in an emergency.

1. Mixing boating and alcohol. Remember, the skipper is responsible for his crew, passengers and vessel.
2. Trying to reach the bow by the deck walk-around at unsafe speeds. Use the center walk-through.
3. Someone sitting on the bow, deck, or swim platform while underway.
4. Choosing a boating outing day with inclement weather, especially in high winds and thunderstorms in the forecast or staying out when bad weather is approaching.
5. Disembarking without checking all the fluids or systems, and especially fuel system components.
6. Not monitoring the boating traffic or possible obstructions around you.
7. Emergency communications equipment, signaling devices, and navigation lights not working.
8. Improper boat handling especially high speed turns in rough water. Using trim improperly.
9. Being too far from shore with inadequate fuel supply or navigational aids.
10. Passengers, especially children that are not wearing the proper life saving devices.
11. Skipper or passengers not seated in the boat.

REPORTING BOATING ACCIDENTS



According to the Federal Boat Safety Act of 1971 involving collision, accident or other casualty, the operator must make a formal report within 48 hours to the nearest state

boating authority when the incident involves:

1. Death
2. Injury requiring treatment other than first aid
3. The disappearance of someone from a boat under death or injury circumstances.

A formal report must be made within 10 days for accidents involving more than \$2000 damage or complete loss of vessel.

For information regarding accident reporting, please call the **Boating**

Safety Hot line at 800-368-5647.

If there is no state provision for reporting boating accidents a report must be made to the Coast Guard officer in charge, Marine Inspection Unit nearest to the accident site or USCG station.



RENDERING ASSISTANCE

The operator of a vessel is obligated by law to provide assistance that can be provided safely to any individuals in a dangerous situation on the waterway. The operator is subject to fine and or imprisonment for failure to do so.

DANGER

AVOID BODILY INJURY OR DEATH FROM
FALLING OVERBOARD! ALL OCCUPANTS
SHALL STAY SEATED IN THE COCKPIT
WHILE THE BOAT IS RUNNING.

FEDERAL REGULATIONS REGARDING VESSEL SECURITY

Federal maritime regulations contain specific information when operating near naval vessels, oil tankers and cruise ships.

1. You may not approach within 100 yards of any U.S. naval vessel, oil tanker, or cruise ship. When this is impossible to avoid, you must contact either the vessel or the Coast Guard escort vessel on channel 16 of the VHF radio.
2. Also, you must operate at minimum speed within 500 yards of these vessels.

WARNING

Do not approach within 100 yards of any U.S. naval vessel. If you need to pass within 100 yards of a U.S. naval vessel in order to ensure a safe passage in accordance with the Navigation Rules, you must contact the U.S. naval vessel or the Coast Guard escort vessel on VHF-FM channel 16.

OPERATE AT MINIMUM SPEED

You must operate at minimum speed within 500 yards of any U.S. naval vessel and proceed as directed by the Commanding Officer or the official patrol.

Violations of the Naval Vessel Protection Zone are a felony offense, punishable by up to 6 years in prison and/or up to \$250,000 in fines

Safety On Board

WATER SPORTS

Besides learning the safety precautions for safe boating, as well as understanding and knowing required rules and regulations, you are obligated to be particularly careful around other water sportsman, such as scuba divers, water skiers, wake boarders, and fisherman.

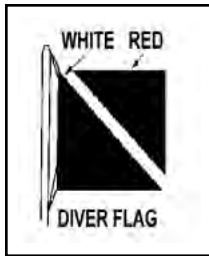

Whenever you see a “Diver Down” flag, maintain a distance of at least 100 feet on inland waters. In bays and open waters stay 300 feet away. The flag indicates a diver in the water. If a diver is operating from your boat, be certain to use this flag and post a lookout on board to observe the diver’s

air bubbles.

SWIM PLATFORM

On integrated or extended swim platforms you should make periodic inspections of the swim ladder and hardware that supports the platform to ensure that all connections and fittings are tight and in good condition.

Use heed when operating the boat in reverse to insure that water does not accumulate excessively on the platform or transom, especially in rough seas or strong currents. Do not exceed the recommended maximum capacity label!



Typical label shown.

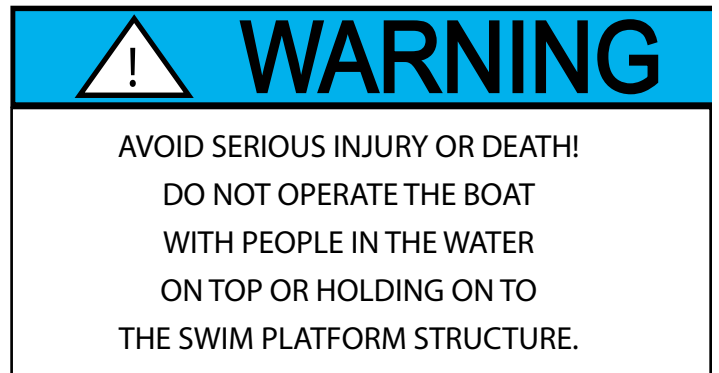

Read and understand the warning label above regarding “teak surfing.”

FISHING



Most boaters fish from time to time. With the propulsion systems of today it is possible to fish in out-of-the-way places. When cruising, stay clear of fisherman. They may have lines or nets out which might be cut or get caught in your propeller if you come too close. Slow down when

approaching fishing boats. Do not return to cruising speed until the boats have been passed. If a fishing boat should be anchored, a large wake could flip or swamp the boat, upset fishing gear, pull the anchor loose from the bottom or worse yet cause someone to fall overboard.

When fishing from your boat, never anchor in a shipping channel or tie up to any navigational aid. These must be kept clear of at all times.

Be sure to carry a local chart of the area to back up your plotter and be on the lookout for shallow water and hidden obstructions. Many times local conditions change and there is a time lag on the plotter chip until the next revision.

Pick up a tidal chart if appropriate so you do not end up grounded.



WEATHER/WATER CONDITIONS WAVES & FOG

Before a boating outing check the weather conditions. As we all know the weather can change rapidly in many parts of the country. It does so sometimes without being predicted. NOAA weather radio reports are continuously available on designated frequencies installed on VHF radios and various hand held devices. Also, many local radio stations carry weather reports along with on-line information.

CLOUD FORMATIONS

Clouds indicate the type of current weather and upcoming changes in the weather. Knowing the type of cloud formation can assist you in understanding current weather. Flat clouds (stratus) normally indicate stable air. Cumulus clouds indicate unstable air. Many times a “cotton ball” or cumulus cloud builds vertical height in the afternoon and the result is a thunderstorm with increased winds and waves; sometimes these storms are quite violent. Also, water spouts with high vortex winds can develop over water. You can find additional weather information (meteorology) at your local library or on the internet.

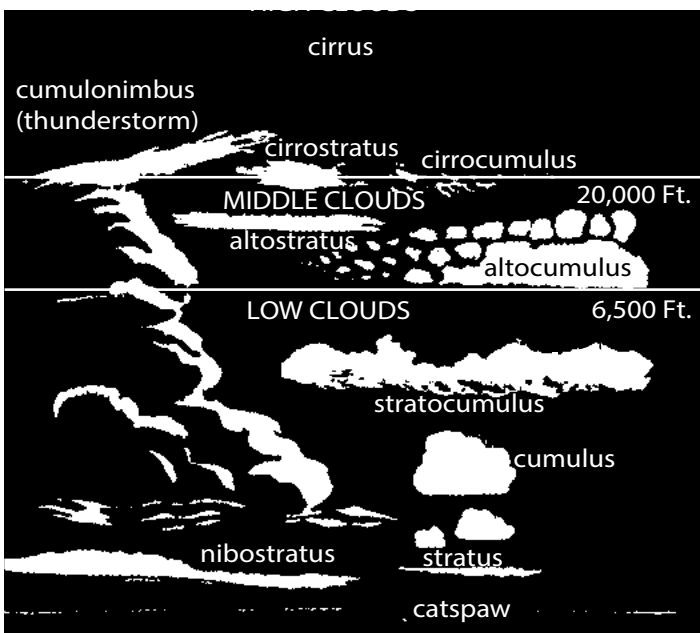

As the wind blows across water waves are created. The stronger the wind and increased distance across the water enlarges the wave action.

Other factors that can cause problem situations for vessels are fog, currents, and tidal changes.

Fog can develop inland on clear, calm mornings. Coastal areas see large “blankets” of fog roll in and stay for extended time periods sometimes causing hazardous navigation conditions. If you are caught in the fog, do not panic. Think of the best plan of action and proceed carefully. If you are limited in navigation equipment at the first sign of fog proceed to the nearest shoreline and wait until the fog lifts.

Boats equipped with navigation equipment, local waterway experience and charts should proceed to a safe harbor. Use extreme caution, signal as needed, and reduce to a speed where you can stop within half of your forward vision range.

If foul weather catches you at sea do the following:

1. Slow down. Proceed with caution and put on your life vests.
2. Try to reach the nearest safe shoreline.
3. Navigate your vessel slowly into the waves at a 45 degree angle.
4. Passengers should sit low in the center of the vessel.
5. Monitor your bilge pump. Make sure sump stays free of water.
6. Secure loose gear. Make ready emergency equipment.
7. If the engine stops, throw the anchor over the bow. If needed use a sea anchor. Never anchor off the stern.

Rules Of The Road

NAVIGATION RULES DEFINED



The Navigation Rules set forth actions to be followed by boats to avoid collision. They are referred to as the “Rules of the Road”. There are two main parts referred

to as the inland and international rules. The inland rules apply to vessels operating inside the boundaries of the United States. The international rules (referred to as 72 COLREGS) apply to vessels operating on the high seas and all connected waters outside the established demarcation boundaries. Most navigational charts show the demarcation lines by red dotted lines and are published in the navigation rules. Remember to consult state and local agencies since areas such as “no wake zones,” swimming beaches, “diver down flag” and inland landlocked lakes fall under their jurisdiction. This section is only an introduction to the “rules of the road”. We strongly recommend additional training before getting behind the “wheel” of your boat.

You can order the Inland & International Navigation Rules from:

Superintendent of Documents
U. S. Government Printing Office
Washington, DC 20402
Tel: (202-512-1800) Fax:(202-512-2250)

NAVIGATION RULES

RIGHT OF WAY

1. Cross waves at right angles.
2. When caught in heavy water or squalls, head either directly into the waves or at a slight angle. Reduce speed, but maintain enough power to maneuver your boat safely.
3. Keep your speed under control. Respect the rights of other boaters engaged in all water sports. Give them plenty of operating room.
4. Whenever meeting a boat head on, keep to the right where possible.
5. When two boats cross, the boat to the right (starboard) has the right of way.

 **WARNING**

TO AVOID INJURY AND DEATH
FOLLOW THE NAVIGATION “RULES OF THE
ROAD” TO PREVENT COLLISIONS.



6. When overtaking or passing, the boat being passed has the right of way.

In general, boats with less maneuverability have right-of-way over more agile craft. The skipper must keep his craft clear of the following vessels:

- A vessel not under command or aground; due to their circumstances, these vessels have no maneuverability.
- A vessel restricted in its maneuverability; these vessels usually are performing work which limits their maneuverability. Examples are boats surveying, dredging, laying pipe or cable, or servicing navigational markers.
- A vessel engaged in fishing; these include boats fishing with lines, trawls or nets, but not trolling lines.
- Sailboats; they have the right-of-way over powerboats. However, if a sailboat is using a prop to move forward, it is considered a powerboat even if the sails are up.
- Remember the unwritten “rule of tonnage”. Basically a smaller tonnage vessel should take every effort to avoid close quarters with a larger tonnage vessel. One way to accomplish this is to have a designated human lookout to “eyeball” the horizon for any developing collision course.
- Use defensive driving skills on the waterway just as you do on the roadway. The other vessel may not know the “rules of the road”. Be alert and ready to take immediate action.
- If a collision course is unavoidable neither boat has the right of way. Both boats must react to avoid an accident according to the rules of the road.

LOOKOUTS

International and Inland navigation rules spell out the specifics of establishing a lookout. *A lookout is legally defined by the court system as a person who has specifically charged duties on board such as observing sounds, echoes, lights and any inhibitors to navigation with complete thoroughness as permitted by the circumstances.*

The term “specifically charged” means that the lookout has no other duties at that time that could prevent him from keeping a proper watch.

Of course the skipper must delegate the lookout duties to a seasoned crew member who can react to events quickly and communicate effectively with the captain with little notice. As captain of your yacht you are responsible for the vessel and the crew. Choose an experienced individual as lookout and review the navigation rules with this person so he can make the right call quickly as situations develop.

WHISTLE SIGNALS

ONE LONG BLAST: Warning signal
(Coming out of slip)

ONE SHORT BLAST: Pass on my port side

TWO SHORT BLASTS: Pass on my starboard side

THREE SHORT BLASTS: Engine(s) in reverse

FOUR OR MORE BLASTS: Danger signal

BRIDGE SIGNALS

SOUND	VISUAL	DAY (Flag)	NIGHT (Lights)
VESSEL: Open	— ●	↑	↑
BRIDGE: OK	— ●	↓	↓
No	● ● ● ● ● ●	Same	Same
VESSEL: Replies:	● ● ● ● ● ●	or	or
RADIO: VHF CH. 13		No	No

Rules Of The Road

NAVIGATION RULES

The Navigation Rules set forth 3 types of crossing situations- crossing, meeting, and overtaking. In each case, both boats are governed by special procedures.

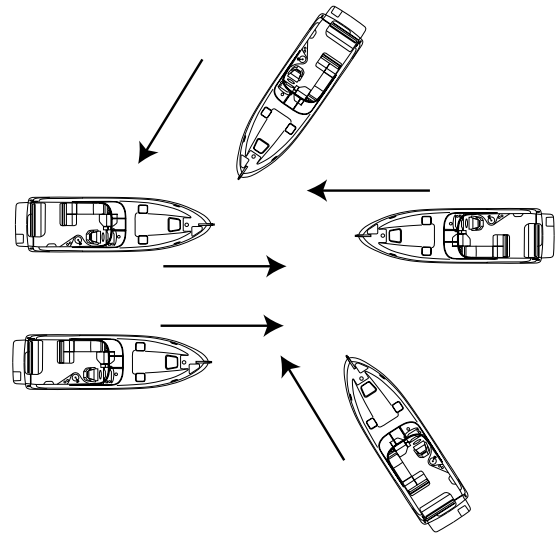

In a head-on meeting, both vessels must sound a single blast to give way toward starboard and pass to port.

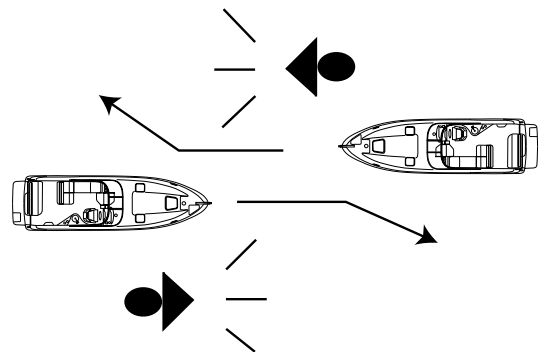

These rules appear when there is a risk of collision. In a crossing situation be aware of the other craft's position. For safety, there should be a noticeable change in the angle, bow or stern; a gradual change in position indicates possible danger.

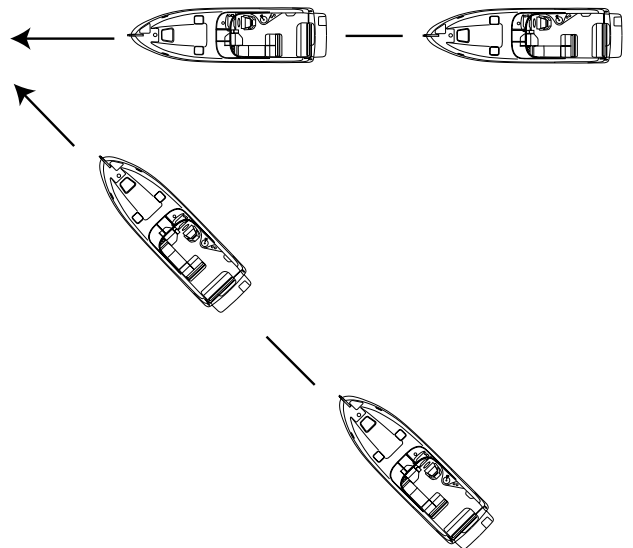



NAVIGATION RULES

An overtaking boat is burdened, and is not the privileged craft, even though it approaches the danger zone of the overtaken boat.

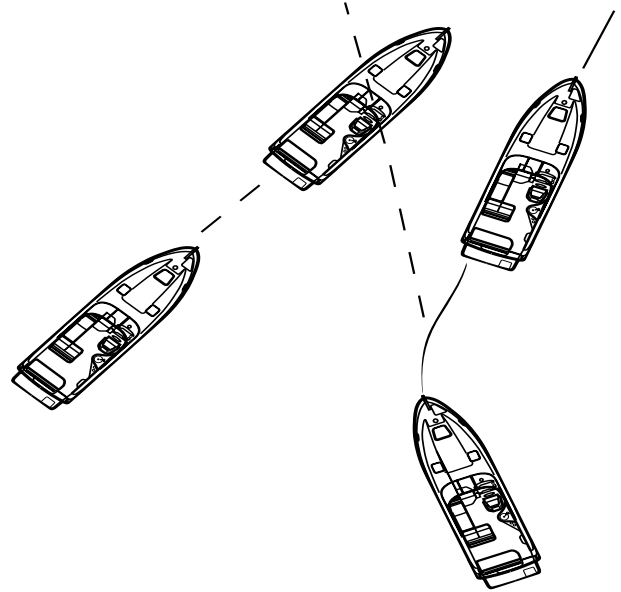

The overtaking boat first signals with a single blast if that boat desires to pass on the starboard side of the boat ahead, or a double blast if passing to port. The overtaken craft responds with the same signal if safe, or with the danger signal (5 short blasts or more) if unsafe. The boat overtaking must not pass unless the appropriate signals are sounded.

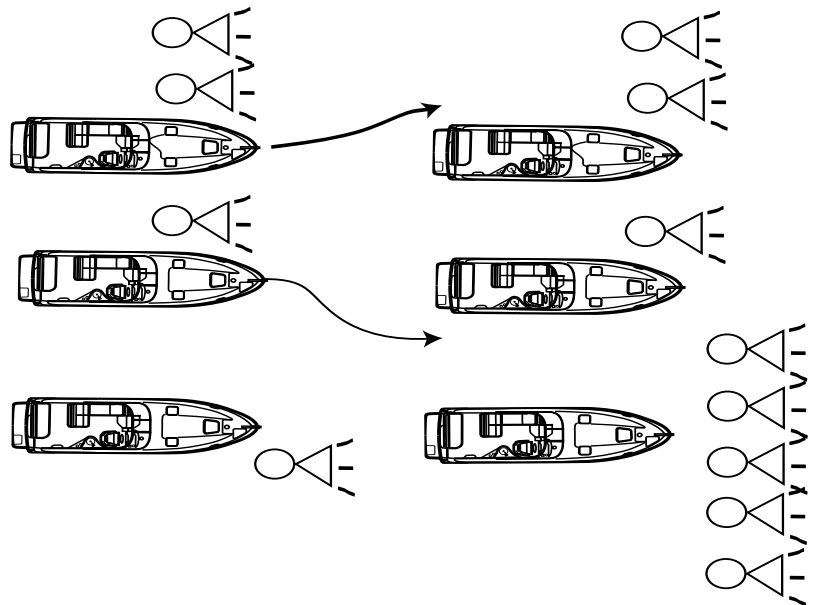

Rules Of The Road

NAVIGATION AIDS



Navigation aids are placed along coasts and navigable waters as a guide for mariners in determining their position in reference to land and hidden danger. Each aid provides specific information. They form a continuous system of charted markers for monitoring on the plotter or providing accurate piloting on paper as a backup.

Your on board plotter provides up to date navigation aids. Besides coastal maps a complete domestic interior waterway grid is featured on the plotter.

If desired, there are hand-held GPS devices that are available as back-up devices. In addition, nautical charts are provided by the National Ocean Service (NOS) and are distributed nationwide through marinas and outlet stores. These charts show the geography of the coast, water depth, landmarks, navigation aids (buoys and markers), marine hazards, and port facilities. Use only up-to-date charts for navigation. We recommend when purchasing a chart to look for the weather resistant ones.

Buoys provide a road map to keep the skipper on course and to avoid hazards. Buoys are identified by light, shape, color and in severe weather conditions by sound.

Buoys or beacons called lateral markers indicate the port and starboard sides of the waterway to be followed. U. S markers follow the buoy system known as Red Right Returning. When returning from sea or traveling upstream, the green markers are to port (on your left) and the red markers are to the starboard side (on your right). When traveling downstream or out to sea the marker color would be reversed.

Before operating your vessel, learn to identify the various navigational aids such as lateral aids, mid-channel markers, information and regulatory markers.

NOTICE

SKIPPERS MUST NOT RELY ON BUOYS ALONE TO MARK THEIR POSITION. SEVERE WEATHER CONDITIONS AND WAVE ACTION CAN ALTER A BUOYS POSITION. NEVER TIE UP TO A BUOY. IT IS ILLEGAL AND DANGEROUS.





LATERAL AIDS

Port Side
Odd Numbers

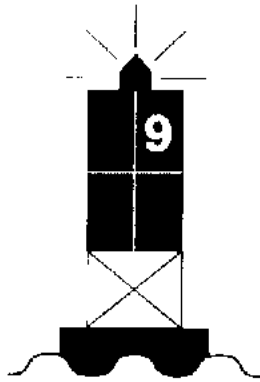
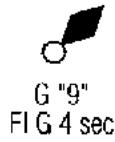

Chart Symbol



Lighted Buoy
(Green Light Only)

Starboard Side
Even Numbers

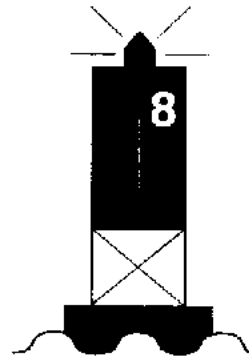

Chart Symbol



Lighted Buoy
(Red Light Only)

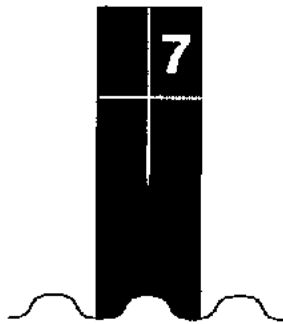

Chart Symbol



Can Buoy
(Unlighted)

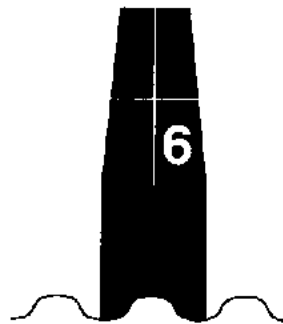

Chart Symbol



Nun Buoy
(Unlighted)



Chart Symbol



Day Mark



Chart Symbol



Day Mark

Rules Of The Road

MID-CHANNEL MARKERS

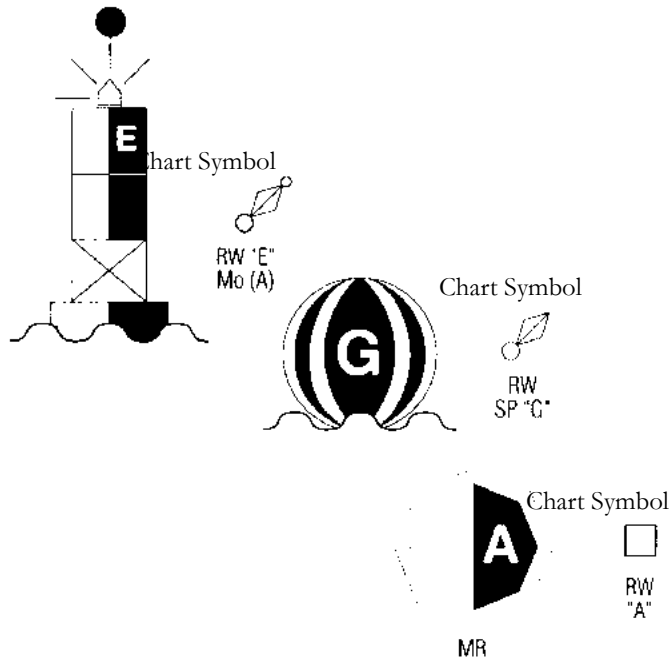

REGULATORY MARKERS

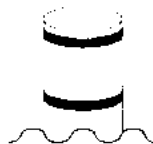

Diamond Shape Warns Of Danger



Diamond Shape With Cross-Boats Keep Out



Circle Marks Area Controlled As Indicated



For showing information such as locations, distances and directions



NIGHT RUNNING

Boats operating between sunset and sunrise (hours vary by state), or in conditions of reduced visibility, must use navigation lights. Night time operation, especially during bad weather and fog, can be dangerous. All Rules of the Road apply at night, but it is best to slow down and stay clear of all boats regardless of who has the right-of-way. To see more easily at night, avoid bright lights when possible. Also, it is helpful to have a passenger (appoint as lookout) keep watch for other boats, water hazards and navigational aids.

To determine the size, speed and direction of other vessels at night, you should use the running lights. A green light indicates starboard side, and a red light indicates port side. Generally, if you see a green light, you have the right-of-way. If you see a red light, give way to the other vessel.

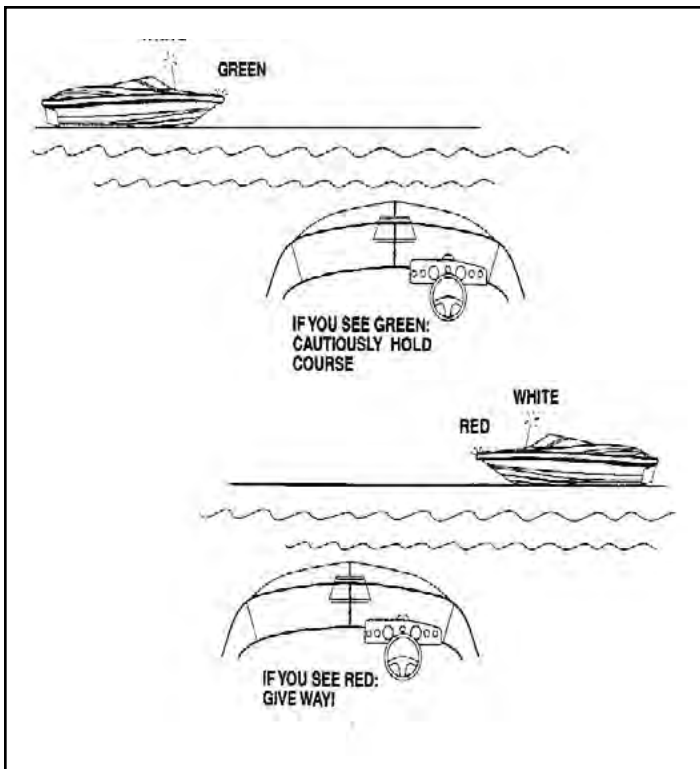

Rules Of The Road

BRIDGE CLEARANCE

Be aware that your vessel requires a specified bridge clearance height. This height is a measured estimate from the waterline to the top of the highest equipment height. The estimated height can change because of variances in the loaded condition of the vessel and equipment variances. Consult the bridge clearance specifications located in Chapter 12 (Technical Information section).

Some bridges are tendered. Know and use the proper bridge signals when approaching these bridges (see bridge signals in this chapter). You can also monitor and communicate on channel 13 of a VHF radio for bridge information in most domestic locals. Other bridges are marked with a clearance measurement and you are on your own. It is recommended that you have a look out posted for additional visual assistance when entering a bridge zone. After determining your vessel will clear the bridge proceed with caution at a safe idle speed. Keep your eye on vessel traffic at all times in order to react quickly. Keep both hands on the helm since you may need to change course because of current and wind conditions. Resume a safe speed once clear of the bridge structure and acknowledgment of clear visibility.

Just use common sense around any type of bridge structure!

BRIDGE LIGHTING

Bridge lighting is maintained by the Department of Homeland Security. On the following pages are 2 typical examples of night-time bridge lighting. As the skipper approaches bascule and fixed bridges light position (arc of visibility) and color will indicate the safe channel through the bridge. Notice green denotes the “safe” entry location on single-span bridges and green or white on multiple-span bridges designates the main channel. In addition, green denotes the “up” position for single and double lift bridges.



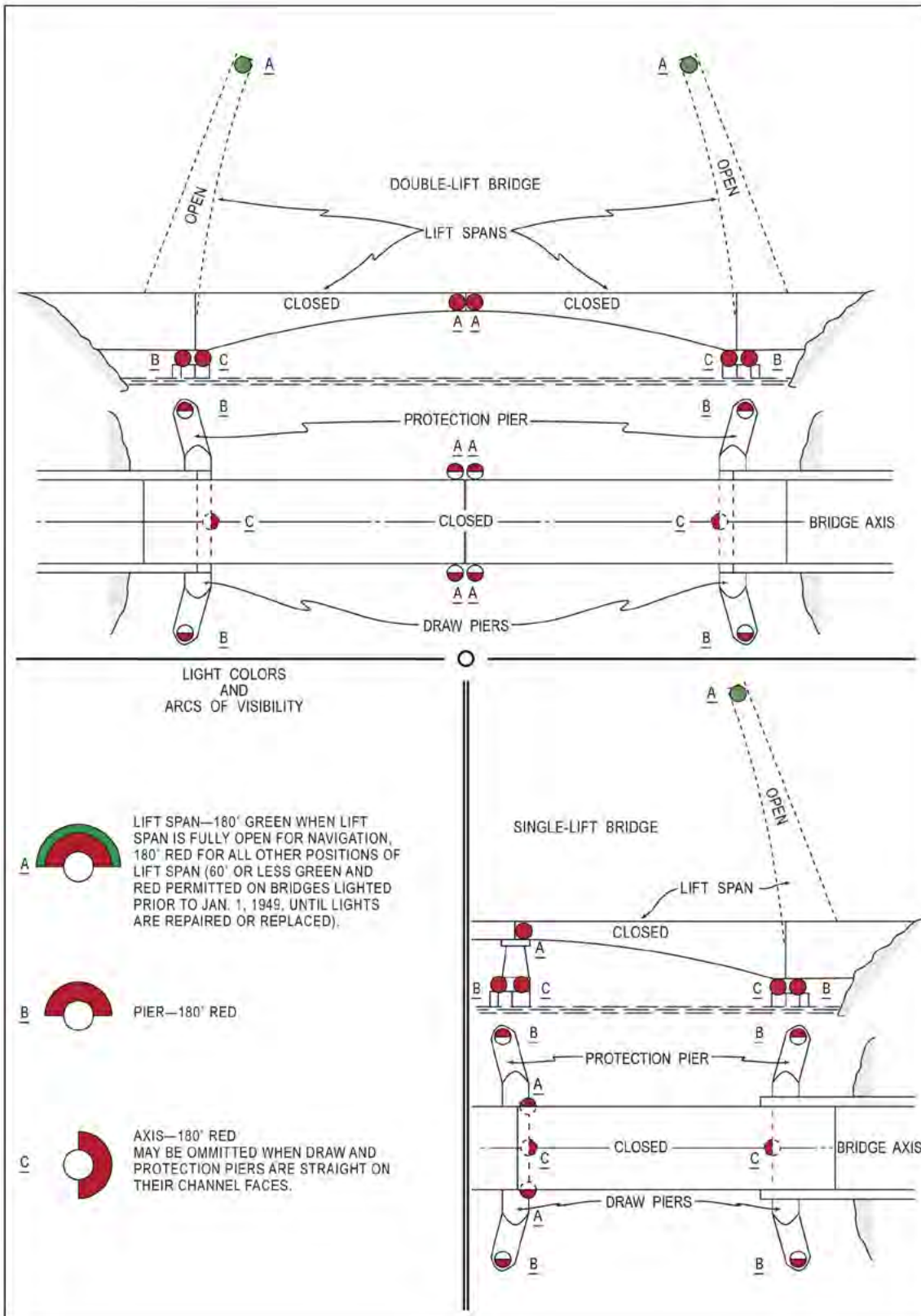

Rules Of The Road

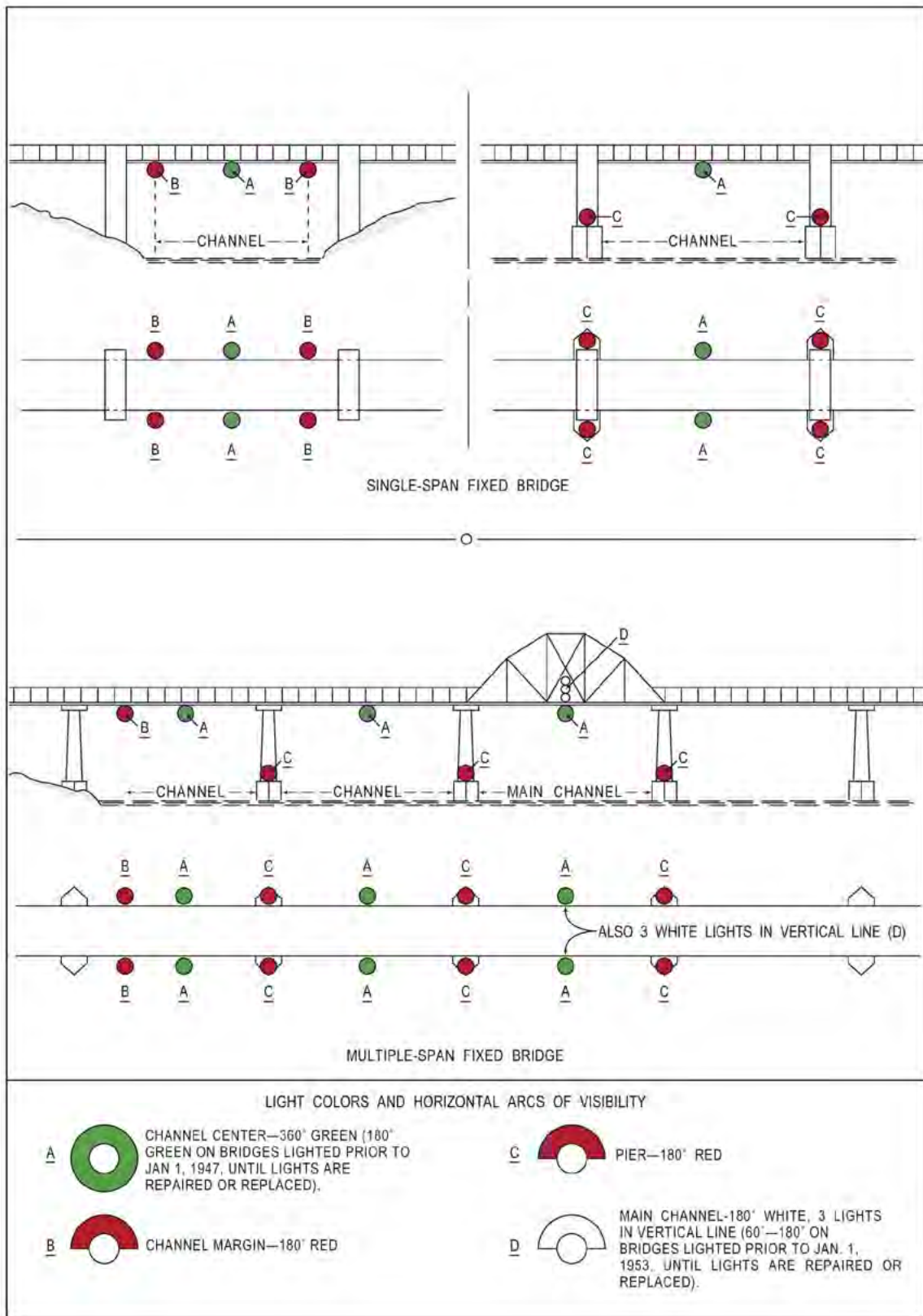

Systems

OVERVIEW

In this chapter Regal stern drive on board systems are introduced. Information includes several main systems including fuel, electrical, air conditioning (AC), windlass, water, waste, electronics, entertainment and trim tabs. This is the “meat and potato” section for equipment operation.

A portion of the systems are identical for the outboard model so it makes sense to read this chapter completely. More specific outboard systems are found in the outboard section following the stern drive segment.

Note on outboards where the optional generator is installed an automatic fire extinguishing system is installed.

A system description, location of components, operational information along with common problems and solutions are covered with each of the system components. Enhanced vendor component details can be found in the owner’s information packet.

Be sure to read and follow any danger, warning, or caution labels in reference to boat systems or individual equipment components.

Your Regal boat may not contain all of the equipment or systems shown. Regal has the right to modify, update or delete equipment and/or systems at any time. Refer to the vendor documentation located in the owner’s information packet for more detailed information of individual system components.

STANDARD FIRE PORT



Note that for stern drive models as standard equipment there is a fire port and plug installed in the aft cockpit near the engine hatch. The plug includes a decal. In a fire emergency place a hand held fire

extinguisher in the port and pull the pin to evacuate the agent. See the photo above for typical fire port. Locate the fire port on your vessel, point out to passengers and make everyone aware of emergency procedures related to the fire port. Make sure an approved portable fire extinguisher of the correct type and weight is aboard and located for fast access in case of fire.

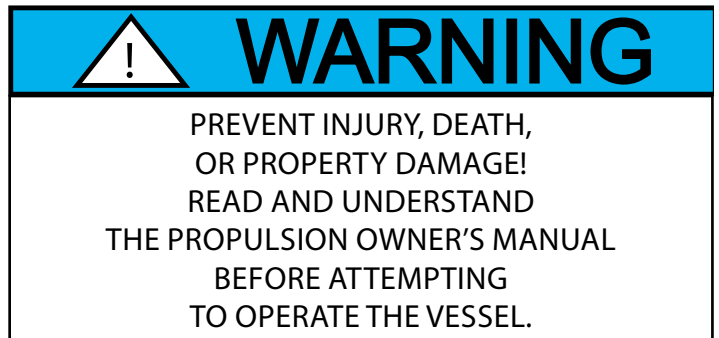

TYPICAL GASOLINE FUEL SYSTEM

In this section, a typical EPA approved domestic gasoline fuel system with components is introduced. The fuel system includes the fuel tank, fuel feed lines, fill and vent fittings along with fuel filters, emission devices natural and powered ventilation systems.

Gasoline today is processed in a different manner than it was a few years ago. As a result it has become more unstable and the product shelf life has been shortened.

As part of the Volvo product features the gasoline engine EVC system and transmissions are all protected by a fault handling system should a malfunction develop. A portion of this fault system is used to monitor the gasoline fuel system. Mercruiser propulsion systems offer “Smartcraft” technology which delivers key engine functions.

Select codes warn the captain with a “buzzer” sound while others will display on the helm tachometer, display, or alarm panel. The “pop-up” will alternate between the cause of the fault and a task to perform to aid in eliminating the situation.

It is important to read and understand your Volvo or MecCruiser propulsion owner’s manual in order to react to a fault code should a malfunction display on the instrumentation or an alarm sound.

GASOLINE SPECIFICATIONS

Gasoline Requirements- Use non-leaded gasoline with the following minimum octane rating:

- Inside United States-(R+M)2 (AK)- 87
- Outside United States- (RON) -90

The use of leaded fuels will damage the catalysts and can not be used with catalytic converters.

Gasoline in the United States and other areas is blended with 10% ethanol and is known as E-10 at the pumps. Marine engines used in your Regal boat may be operated with gasoline blended with no more than 10% ethanol and that meets the minimum octane specification.

Do not use ethanol blends greater than 10% such as a newer blend for select motor vehicles called E-15. Your marine engine may be damaged by more than 10% ethanol. A loss of performance may occur and the engine will not be covered by the engine manufacturer’s warranty.



TYPICAL EPA FUEL SYSTEM

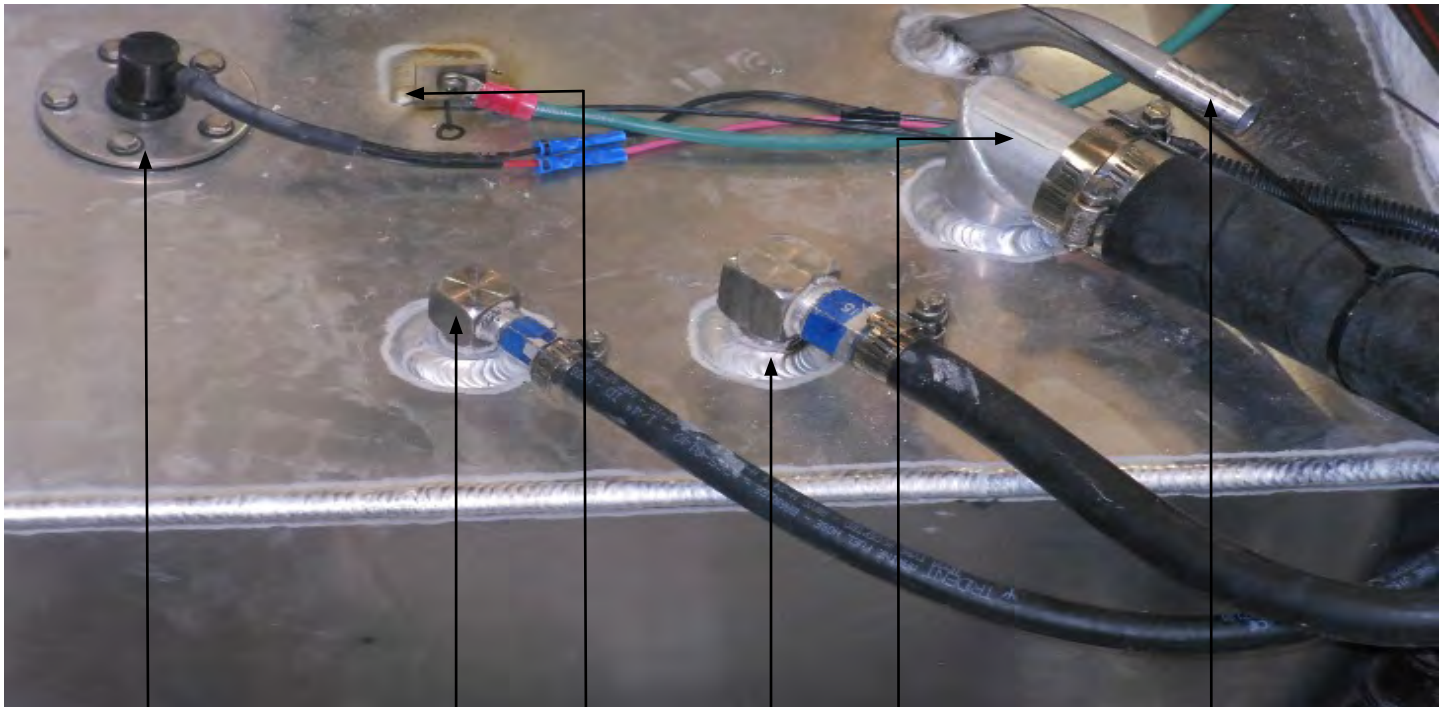

FUEL
SENDER

GENERATOR
FEED/OUT-
BOARD ONLY

TANK
GROUND

ENGINE
FEED

FUEL FILL

VENT

FUEL TANK

Boats manufactured for domestic use are now required to be outfitted with an EPA compliant fuel system using an aluminum tank. This system uses parts such as special baffle valves located inside the fuel tank to prevent fuel sloshing. Also, there is a carbon canister which functions much like the one in an automobile. This component is located between the fuel tank and hull side vent. The carbon canister never needs to be replaced and is not a serviceable item.

Tanks are initially outfitted to work with gasoline and diesel systems.

These tanks are tested and inspected along with the complete fuel system several times for safety requirements and quality by the fuel tank supplier, in house personnel and independent inspections by National Marine Manufacturers Association inspectors.

FUEL FILL FITTING

The fuel fill fitting is labeled “gas” and in addition displays the international symbol (See the next page). When fueling the boat keep the fill nozzle in contact with the fuel fill pipe since it decreases static electricity. Always use the recommended fuel octane rating as specified in your engine owner’s manual.

Extinguish all flame producing agents before fueling!

FUEL VENT FITTING



**COMBO FUEL FILL W/
INTERNAL VENT**

Currently, domestic EPA compliant fuel tanks vent fumes back into the fuel tank system. While the tank is filled, air displaced by the incoming fuel is vented through the fuel

system charcoal canister.

Your vessel uses a combo type (internal vented) fuel fill. Both the fuel fill and vent occupy the same cavity under a protective cover. If fuel overflows through the vent the design forces it back into the fuel fill hose and tank.

A seasoned skipper will hear a distinct sound as the tank nears the “top out” or full mode and may see fuel overflowing back into the fuel hose through the vent.

DO NOT OVERFILL THE TANK.

This helps avoid any overboard spills which harm the environment.

Note: On select vessels there is a key that fits into the fuel fill cap. Use it to secure the fitting from leaking fuel. Store the key in a safe place so it can be easily found for fueling. Check the vent fill screen periodically for debris.

ANTI-SIPHON VALVE



INTERNAL BALL/SPRING

The *gasoline* fuel tank feed lines that run from the fuel tank to the engine fuel components each use an anti-siphon valve. The valve is threaded into each fuel tank fitting

at the feed line. The valve is pulled off its seat by fuel pump pressure as the engine is cranking or running. There is a ball and spring assembly inside the valve that is activated by fuel pump impulses. It allows a one-way fuel roadway to the engine fuel system. It prevents fuel from siphoning out of the tank in the event of a fuel line rupture or disconnected fuel feed hose. When the engine fuel components stop the fuel from cycling the spring forces the ball against the valve opening to stop fuel flow.

Note that vessels with generators will feature an anti-siphon valve at the generator fuel feed location.

Never remove an anti-siphon valve as it is a fuel system safety component. Also, never remove the ball and spring from the valve assembly. The anti-siphon valve requires no normal maintenance. Symptoms indicating possible valve problems may be fuel starvation at intermediate or high rpm or in extreme cases an engine that will not start.

Contact your Regal dealer for further information.



FUEL GAUGE/SENDER

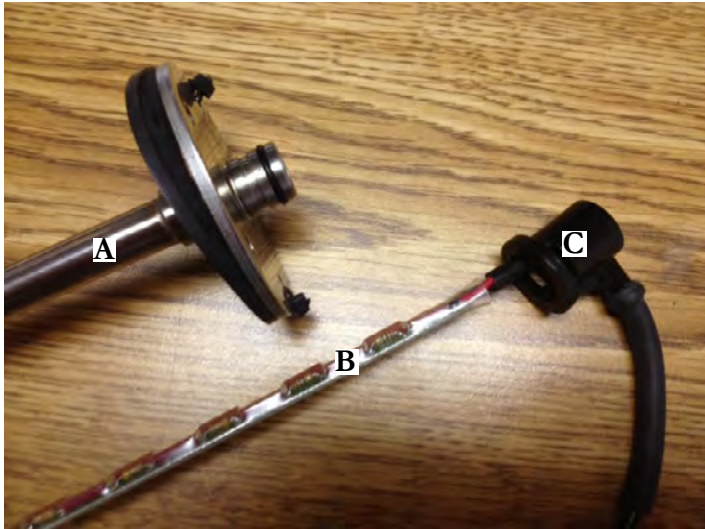

The dash fuel gauge is only an indication of the on board fuel supply. They are not exact reading instruments. Therefore, use the one third rule discussed earlier for monitoring your fuel supply. *There are not many filling stations on the open waterways!*

The gas sender located in the fuel tank uses a float system which sends a signal to the dash fuel gauge as to the estimated fuel tank level.

The new sending units feature a removable tube (B) which inserts inside the stainless steel sender (A) without having to remove the entire unit found in earlier units. The unit requires as little as 3" height to remove the tube. Also, a liquid-tight strain relief connector protects the harness.

A buna-N type float travels the length of the sender tube (A) as the fuel level changes. The resistors inside the tubing read the float level and send a signal to the dash gauge.

As an emergency tip in the event the fuel gauge shows no gauge activity or reads improperly:

Check the sender by disconnecting the 2 sender leads at the fuel tank and connecting an ohm meter between them. Make sure you zero out the meter by first connecting both red and black leads together and then adjusting the meter knob to zero. This needs to be performed to obtain a correct ohm reading. *The actual resistance between the sender leads should be between 30 and 240 ohms.*

FUEL FILTERS

Fuel filters are installed on your marine engines. They are of the spin on type similar to an automobile oil filter. Their main purpose is to trap dirt particles and condensation in the fuel system before it reaches the injectors. Impurities can clog up the injection system. It is a good idea to keep an extra set of fuel filters on board along with a filter wrench, catch container and clean rags for emergencies. Never use automotive style fuel filters on your vessel. Dispose of all fuel residual materials in an environmentally safe fashion.

CARBON CANISTER

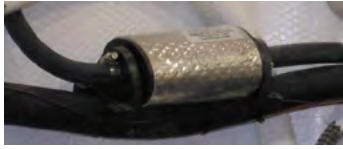

The domestic EPA compliant fuel tank system contains a carbon canister. (one for each fuel tank). It is located in the engine room (bilge or sump). Its environmental mission is to catch and filter any contaminants that are attempting to exit the fuel system via the fuel tank vent hose. This component should last the life of the fuel system and requires no periodic maintenance other than periodically checking the hose clamps for tightness.

VENTILATION SYSTEM

Gasoline propelled engines require a continuous supply of fresh air in order to generate peak horsepower and rpm. To deliver fresh air for the engine a permanently mounted vent is integrated into the boat's deck on both port and starboard sides. **This is called the natural ventilation system.**

When the engine is started fresh air is drawn through the vent system. As the demand for air increases in relationship to the engine revolutions per minute (rpm's) the engine induction system supplies the required additional air supply by inhaling more air.

As part of the gasoline combustion process fuel vapors can accumulate in the bilge and cause a possible explosion or fire. To offset the possibility of this happening a powered ventilation system exits fuel vapors and possible CO through a system of blowers with hoses that are strategically placed in the lower third of the engine compartment. There is one blower per engine. Gasoline vapors naturally seek the bilge bottom and the blowers evacuate any fuel vapors out the exhaust side of the ventilation system. **This is known as the powered ventilation system.** If you are working in the sump make sure you do not step on the black 4" blower hoses.

Check the vents periodically for any obstructions or foreign objects such as nests or spider webs. If the propulsion system is running at a lower than normal cruising rpm or seems to lack power or the vessel is slow to plane check the fresh air supply to the engine including the engine air filters.

Note that proper amounts of natural ventilation is even more important with diesel installations.



GASOLINE FUEL SYSTEM-GENERAL LABELS

NOTICE

SINCE GASOLINE IS AVAILABLE IN VARIOUS OCTANE LEVELS, REFER TO THE ENGINE MANUFACTURER'S OWNER'S MANUAL FOR THE CORRECT ONE FOR YOUR ENGINE. USING IMPROPER OCTANE FUEL CAN CAUSE ENGINE DAMAGE AND VOID THE WARRANTY.



DANGER

AVOID PERSONAL INJURY OR DEATH! GASOLINE IS A HIGHLY FLAMMABLE AND EXPLOSIVE MATERIAL. PRACTICE "NO SMOKING" AND EXTINGUISH ALL FLAMMABLE MATERIALS WITHIN 75 FEET OF THE FUEL DOCK.



WARNING

GASOLINE VAPORS CAN EXPLODE!
BEFORE STARTING ENGINE
OPERATE BLOWERS 4 MINUTES AND
CHECK ENGINE COMPARTMENT
FOR GASOLINE LEAKS AND VAPORS.
RUN BLOWERS BELOW CRUISING SPEED.



WARNING

AVOID SERIOUS INJURY OR DEATH
FROM EXPLOSION OR FIRE!
NEVER STORE FUEL OR FLAMMABLE
LIQUIDS ON BOARD.



WARNING

AVOID SERIOUS INJURY OR DEATH
FROM EXPLOSION OR FIRE
RESULTING FROM LEAKING FUEL.
INSPECT ENTIRE FUEL SYSTEM AT LEAST
ONCE A YEAR.

POSSIBLE GASOLINE FUEL PROBLEMS/ SOLUTIONS



1. Engine is hard to start or idle rough-

This problem can be caused by foreign particles or water in the fuel system or a blockage in the fuel supply which causes a lean condition.

Check all fuel system lines, clamps, fittings and filters for tightness. Check the entire system for fuel leaks.

2. The engine hesitates at intermediate speeds or fail to obtain top rpm-

Check the fuel system for possible leaks, clogged fuel filters and/or malfunctioning anti-siphon valve.

3. The fuel tank reads low and the engine is running rough.

The pick-up tube has possibly picked up some residual water from the bottom of the fuel tank.

Pour dry gas into the fuel fill fitting and fill the gas tank with fresh fuel. Test run the engines to purge impurities from the fuel system.

4. Fuel tank gauge not reading correctly/or not at all-

If you disconnect the fuel tank sending wire leading to the dash gauge at the sending unit and ground it momentarily with the key "on" the dash gauge should show full. Release the wire from the ground position and the gauge should show empty. Normally this would indicate the dash gauge is working properly. The next item to check would be the fuel sender ohms reading which is explained earlier in this section. Also, make sure the sender wires and ground are securely fastened and the ground wire is tight. Many times a loose ground wire will cause a malfunctioning dash gas gauge or the gauge needle moves erratic.



ELECTRICAL INTRODUCTION



In this section, basic DC (direct current) and AC (alternating current) electrical systems are introduced. Each primary electrical component is reviewed along with its location and function within the Regal electrical system.

For more complicated issues outside the scope of this manual contact your closet Regal dealer. They have undergone

extensive training on the Regal boat systems.

Be sure to read and follow any danger, warning, or caution labels in reference to the boat's electrical system or individual equipment components.



WARNING

PREVENT SEVERE INJURY OR DEATH!
DISCONNECT
ALL ELECTRICAL POWER SOURCES
BEFORE ATTEMPTING
TO REPAIR OR REPLACE
ANY ELECTRICAL COMPONENTS.

DIRECT CURRENT (12 VOLTS)

Your Regal boat uses 12 volt DC electricity otherwise known as direct current. It is called DC because it flows only one way in a circuit. Specifically to name a few, helm gauges, batteries, battery cables, engine electrical components, engine wiring harnesses, dash switches, selected lighting, shower sump, bilge pumps, and vacuum toilets are all components using a 12 volt DC system.

In the DC system used in the United States the red wire is designated as the “hot” or conductor wire and the black wire is referred to as the ground wire. At times other current carrying wires are color coded such as blue to identify their use as a low voltage conductor. This is especially helpful in troubleshooting and adding additional equipment. Be sure to review the wiring schematics in the drawing section of the technical chapter.

Direct current is stored in the ship’s batteries and *produced* through the engine alternator while the engine is running or by the battery charger at dockside.

The alternator charges the batteries by sending current through the main distribution panel relays, battery switches and harnesses to the appropriate battery. Normal DC voltage is between 12 and 15 volts. Lower or higher readings could indicate a charging malfunction or a weak battery.

The engine alternator used on your boat is internally self “excited” and produce DC current at idle. Normal stern drive alternator output would be around 105 amps.

Typical battery set-up includes:

The port battery is normally used to start the engine.

The starboard battery is the “house” battery and it controls many component functions.



TYPICAL BATTERY (12 VOLTS) DESCRIPTION

On board the boats direct current (DC) is *stored* in the ship's "wet cell" batteries. There is one engine starting battery and a "house" battery. The batteries may look identical but their functions are specific and unique.

BATTERY SPECIFICATIONS			
Battery Type	Group	CCA @32 Degrees F.	Reserve Capacity
Engine Cranking	31A	1190	195 min.
House	31 A	1190	N/A

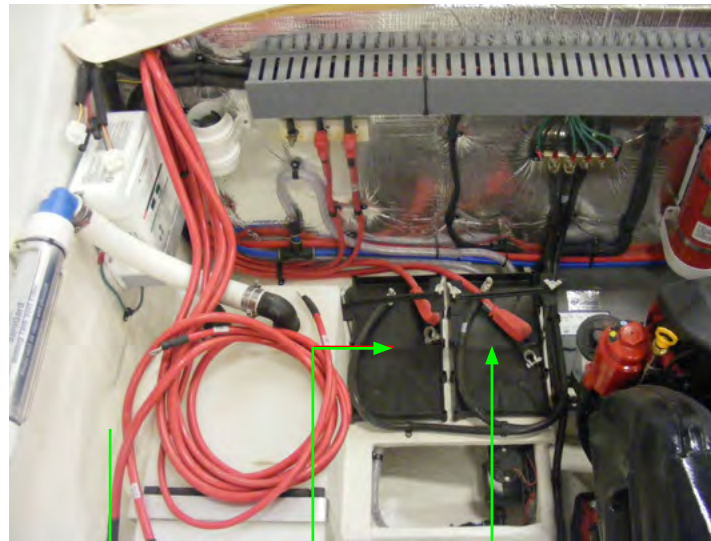

**ENGINE
STARTING
BATTERY**

**HOUSE
BATTERY**

BATTERY TERMINOLOGY

Group- Batteries are divided into groups which identify the height, length, and width of the battery. This is useful information should a replacement battery become necessary.

Cold Cranking Amps (CCA)- This rating measures the cranking power a full charged marine battery has available to start at 32 degrees F. Basically, the higher the rating the greater starting power of the battery.

Reserve Capacity (RC)- As usage on the boat increases so does the need for more reserve capacity. The reserve capacity represents the length of time in minutes a new fully charged battery can maintain the boat's electrical needs without the engine running or in the event the alternator fails.

POSSIBLE PROBLEMS/SOLUTIONS



1. Weak battery- This battery problem can be caused by low electrolyte cell levels. Warm engine compartment temperatures will deteriorate a battery's life quicker by evaporating the water from the electrolyte, thus corroding and weakening the positive grids inside the battery.

With the house battery low electrolyte levels can be monitored by periodic inspection and filling as needed with distilled water. Boaters in higher climate areas with longer stretches of hot weather will need to check their batteries more often.

If installed "maintenance free" engine cranking batteries require no water. They do feature a different chemistry that does consume less water. Inside the cells as gases are released condensation is formed which aids in maintaining the cell electrolyte level. These batteries incorporate a deeper layer of electrolyte over the plates, but eventually it can run dry.

2. Dead Battery- Either the battery will not accept a charge, hold a charge or the charging system is not supplying a charging current through the battery charging system and/or engine alternators.

The battery charger output can be checked by monitoring the lights on the charger front face.

To begin with check the battery post connections for tightness and corrosion.

With the engines running the displayed voltage of the port or starboard engine battery and house battery should be between 12.5 up to 14.6 volts. If less than 12 volts check for voltage across the battery terminals.

Batteries should be removed from the vessel if necessary and trickle charged. If readings after charging are still low replace the battery.



TYPICAL BREAKER

As part of the battery circuit protection from the battery to the battery management system panel a breaker is installed within 40” of the battery. If the breaker would draw excessive amperage it is possible it could “blow”. At this



point it would need to be reset. Always determine the reason why the breaker blew before resetting it.

To reset the breaker move the lever from the “off” position to the “on” position. The 3 Buss brand breakers are ig-

niton protected which means they are sealed providing protection from spark sources.

POSSIBLE PROBLEMS/SOLUTIONS

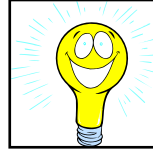

1. **A breaker at the battery management panel does not function-** The breaker is blown. Reset the breaker after determining the cause of the problem.

TYPICAL BATTERY CHARGER CIRCUIT



As part of the battery management panel there is an ACR (automatic charging relay) which distributes automatically as needed current from the battery charger to the appropriate battery. This component is located on the aft side of the battery management panel.

NOTE: As part of the battery circuit protection from the battery to the battery management system panel a breaker is installed within 40" of the battery. These breakers are located in the bilge.

As an option a 20 amp battery charger may be installed for domestic use. The charger output operates automatically at sea based on the component demands and is supplied current through the engine alternator.

At moored positions, there is an on board 3 prong receptacle to plug into the vessel. Once plugged into the receptacle run a correctly amperage sized extension into the marina power box. Make sure there is slack in the extension cord and there cord is not in the water.

Note: Make sure the extension cord is capable of handling up to 20 amps.

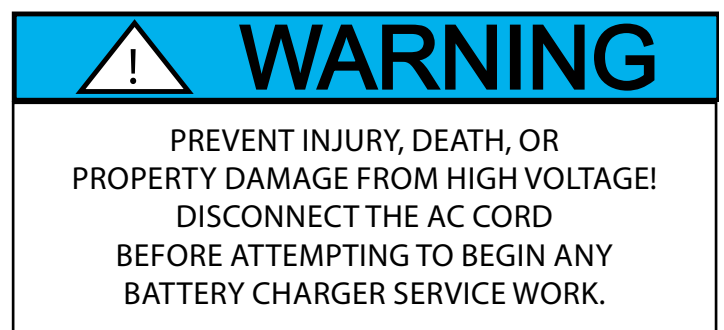



TYPICAL BATTERY MANAGEMENT SYSTEM-PARTS DESCRIPTION



ENGINE BATTERY SWITCH

COMBINE CRANKING-BATTERIES FOR EMERGENCY STARTS

BREAKER CLUSTERS

The battery management system is an important ingredient of the 12 volt direct current (DC) system. Refer to the battery management information in this section and the technical chapter for a breaker amperage listing. Be aware that in some cases the breaker protects a component; in other cases it may control a sub-panel or parts of a sub-panel.

Engine Battery- Controls Windlass Breaker

House Battery- Controls Cabin Main & Dash Main, Breakers

TYPICAL BATTERY MANAGEMENT SYSTEM-PARTS DESCRIPTION CON'T

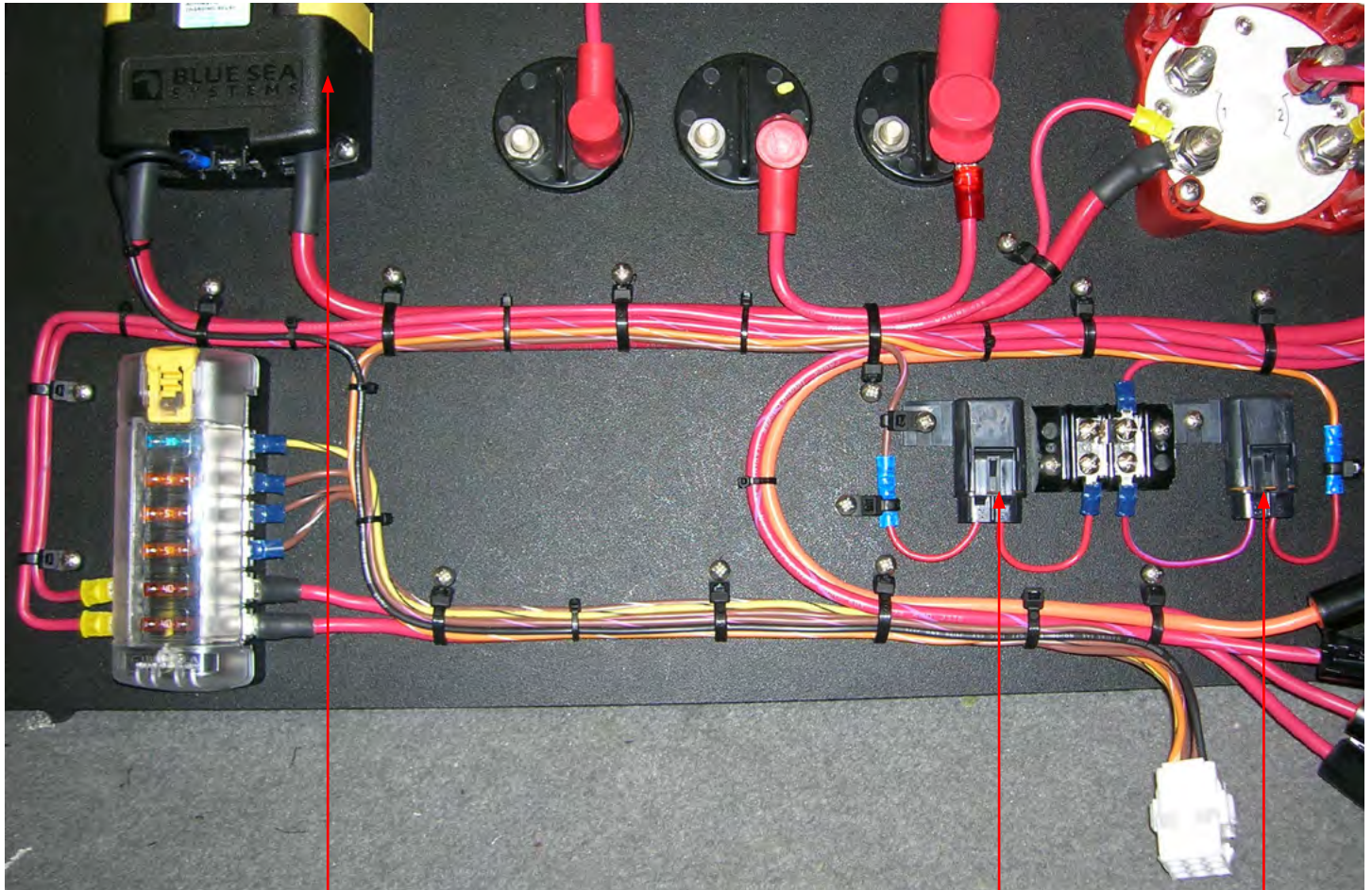

ACR- AUTOMATIC
CHARGING RELAY

CO FUSE

HALON FUSE



UNDER GALLEY FUSE BLOCK

LEFT SIDE

1. ELECTRIC HEAD 30 AMP
2. WATER PUMP 15 AMP
3. HEAD VENT BLOWER 5 AMP
4. MACERATOR 10 AMP
5. LEVEL MONITOR 3 AMP
6. OPEN

RIGHT SIDE

1. REFRIGERATOR 15 AMP
2. STEREO 10 AMP
3. CO MONITOR 3 AMP
4. CABIN LIGHTS 15 AMP
5. SALON TV 10 AMP
6. OPEN

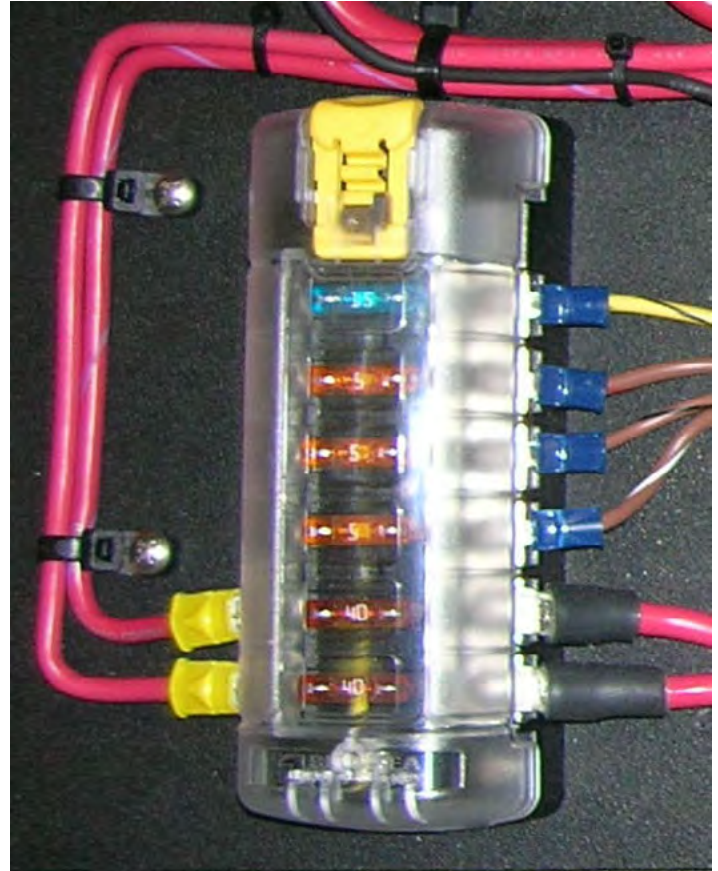

Main Circuit Breaker Cluster

CABIN MAIN- (70 AMP) protects the cabin main DC panel which controls direct current switch functions throughout the vessel.

DASH MAIN- (70 AMP) protects dash operation switch functions, engine hatch panel. In addition, it controls components located on the helm breaker panel. Note that engine functions are not controlled by the dash main breaker.

WINDLASS- (40 AMP) protects the deck mounted anchor windlass circuitry.

POSSIBLE PROBLEMS/SOLUTIONS

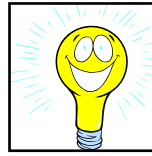

- 1. It is possible that one of the battery management system main circuit breakers may trip from long-term arcing and heat. The breaker may need to be reset-** This might happen occasionally with one of the battery charger breakers.
- 2. Breaker will not reset-** Replace the breaker. Contact the nearest Regal dealer for replacement parts.
- 3. Breaker continues to “trip”.** Check the affected equipment to determine if it is responsible for the excessive draw to trip the breaker. If the equipment is determined to be within specifications check for a “short” in the wiring circuit. Also, the breaker may be faulty. Contact the nearest Regal dealer.



Below are the common breakers that will be “on” or activated when you leave the vessel for extended periods of time with both master battery switches off at the management panel.

UNIVERSAL BATTERY SWITCHES “OFF”

1. Battery charger
2. Forward bilge pump
3. Aft bilge pump
4. Shower pump
5. Stereo memory

NOTICE

AS A SAFETY FEATURE
THE FORWARD/AFT BILGE PUMP CIRCUITS
ARE CONTINUOUSLY “ON”
EVEN WITH THE MASTER BATTERY SWITCH
IN THE “OFF” POSITION.



WARNING

PREVENT POSSIBLE FIRE/EQUIPMENT
DAMAGE!
NEVER TURN MASTER BATTERY SWITCH TO
THE “OFF” POSITION WHILE THE ENGINE IS
RUNNING.

Note: As stated above the engine alternator or electronics may be damaged from the current spike created by turning off the master battery switch with the engine running.

TYPICAL 12 VOLT LOWER HELM BREAKER PANEL



The sub-panel is controlled by the dash main breaker located on the battery management center panel.

The skipper should learn the location of all DC breakers on the vessel and the equipment they protect. For example, a breaker may trip on the sub-panel but may not trip the breaker on the battery management panel. Knowing his breaker location will aid the skipper in troubleshooting problems faster.

Remember, always find why a breaker “blows” before resetting it. Refer to the technical drawing section for additional information.

Note: A portion of the DC circuit protection is provided by the fuse block in the galley area as mentioned earlier in this chapter.



TYPICAL 12 VOLT HELM BREAKER PANEL

HORN- protects the horn circuitry.

SPOT LT- protects the deck mounted spot/search light.

TRIM TABS- protects the transom mounted electric-hydraulic trim tab circuit.

NAV LTS.- protects the port and starboard deck navigation lights.

COCKPIT LTS- activates the LED cockpit lights installed on the deck.

HIGH WATER ALARM- protects the helm mounted alarm. Part of the system including the sensor float is located in the engine room.

WIPER- protects windshield wiper circuit.

WINDLASS- protects the deck mounted foot petals.

EXH BLOWER- protects the head exhaust fan.

VAPOR DETECT- protects the gas vapor detector option located in the bilge.

COCKPIT FRIDGE- protects optional refrigerator circuitry.

PLOTTER- protects the optional chart plotter system.

BILGE LIGHTS- controls lights in the engine room.

UNDERWATER LTS.- protects the transom mounted light (under platform) circuit.

HALON- protects the halon fire extinguishing system located in the bilge.

DOCKING LTS.- protects the hull mounted docking light circuitry.

ARCH LT.- protects the power tower actuator circuitry.

AFT BILGE PUMP- protects the bilge pump in the engine room.

ACCESSORY 1 & 2- protects any optional equipment.

VHF RADIO- protects the marine radio circuitry.

GPS (FUSE)- protects the GPS chart plotter circuitry.

NEUTRA SALT- Protects the neutral salt engine related circuitry.

12 VOLT RECEPTACLE PLUG- protects plug-in circuitry.

12 VOLT RECEPTACLE PLUG- protects plug-in circuitry.

TYPICAL 12 VOLT HELM SWITCH PANELS

PORT SWITCH PANEL



STARBOARD SWITCH PANEL





TYPICAL 12 VOLT HELM SWITCH PANEL DESCRIPTION

HORN- toggles the horn system signals as needed.

BILGE BLOWER- controls power ventilation blower.

BILGE PUMP- controls engine room bilge pump.

NAV/ANC- energizes the bow navigation lighting and all around lighting.

COCKPIT LTS- protects the LED cockpit deck cockpit lights.

WIPER- activates the driver side windshield wiper.

UNDERWATER LTS- energizes the optional transom mounted underwater lighting system.

ARCH- activates the radar arch dual actuator system which drives the hydraulic rams to raise and lower arch.

WINDLASS- activates the optional windlass up and down anchor system.

Note: Remember that the forward windlass system on and off switch (looks like a battery switch) must be turned to the on position for the windlass system to operate. This switch is used as a safety net to keep the windlass from accidentally operating up or down.

LOCK-OUT SWITCH- Controls power to the up and down windlass switch. To activate the switch you need to rock it forward and press the red button to unlock it.

TYPICAL DC (12 VOLT) WIRING COLOR CODE & SIZES		
BLACK	16,14,12,10,8,6,4,2,2/0,40	GROUNDS
BLACK/WHITE	16	HALON INDICATOR
BLACK/YELLOW	10,16	GRD. DIESEL TRANSFER PUMP, MERC DIESEL STOP CIRCUIT
BLACK/WHITE	10	HALON MAIN GRD. FEED
BROWN/BLACK	10	MACERATOR, SUN ROOF
BROWN	10	SUN ROOF
BROWN	14	AFT BILGE PUMP-MANUAL
BROWN/WHITE	14	AFT BILGE PUMP-AUTO
BROWN/RED	14	FWD. BILGE PUMP-AUTO
BROWN/BLUE	14	FWD. BILGE PUMP-MANUAL
BROWN/PINK	16	CO DETECTOR
BROWN/BLACK	16	SHOWER SUMP PUMP
YELLOW	12,10	BLOWER
YELLOW/WHITE	16	HEAD VENT FAN MOTOR
YELLOW/BLACK	16	STEREO MEMORY
YELLOW/RED	14	ENGINE START CIRCUIT

Note: The list above applies to a number of vessels. Vessel components/wiring specifications may vary depending on the model.

TYPICAL DC (12 VOLT) WIRING COLOR CODE & SIZES (CONTINUED)		
ORANGE	10,12	VACUUM TOILET, REFRIGERATOR, HATCH RAM
ORANGE	16	WIPER RUN
ORANGE/WHITE	16	WIPER PARK
ORANGE/BLACK	10,12,16	HORN, HATCH RAM
BLUE	14	INTERIOR LIGHTS, SWITCHED CIRCUIT
BLUE/RED	14	INTERIOR LIGHTS, CONSTANT HOT CIRCUIT
BLUE/BLACK	16	COCKPIT SOFT LIGHTS
BLUE/GREEN	16	INTERIOR SOFT LIGHTS
BLUE	10	CABIN LIGHT MAIN CIRCUIT FEED
GRAY	14	NAVIGATION LIGHTS, RUN- NING, BOW, TRANSOM LIGHTS
GRAY/BLACK	14	NAVIGATION LIGHTS, AFT AN- CHOR, MASTHEAD
GRAY/WHITE	14	NAVIGATION LIGHTS, MAST- HEAD, FWD. RUNNING LIGHTS
RED	16	POSITIVE FEED- ELECTRON- ICS, GAS VAPOR DETECTOR, BREAKER TO DASH SWITCH FEEDS

Note: The list above applies to a number of vessels. Vessel components/wiring may vary depending on the model.

TYPICAL DC (12 VOLT) WIRING COLOR CODE & SIZES (CONTINUED)		
RED/WHITE	16	WINDLASS CONTROL-DOWN
RED/BLACK	16	WINDLASS CONTROL-UP
RED/WHITE	14	BATTERY PARALLEL-LOAD
RED	14	POSITIVE FEED-ELECTRONICS
RED	12	POSITIVE FEED-ELECTRONICS
RED	10	POSITIVE FEED-AUTO PILOT
RED/VIOLET	10	FUEL TANK TRANSFER PUMP AMPLIFIER POWER
RED	8	POSITIVE FEED- MAIN ALTERNATOR CHARGE
RED	6	POSITIVE FEED- MAIN ALTERNATOR CHARGE
RED	4	POSITIVE FEED-MAIN
RED	2	POSITIVE FEED- MAIN START- ER, BATTERY, GENERATOR
RED	2/0	POSITIVE FEED- MAIN, START- ER, BATTERY
PURPLE	16	STBD.IGNITION, HOUR METER- WINDSHIELD VENT
PURPLE/WHITE	16	PORT IGNITION, HOUR METER, WINDSHIELD VENT
PINK	16	STBD. FUEL TANK SENDER
PINK/BLACK	16	PORT FUEL TANK SENDER
TAN/BLUE	16	ENGINE ALARM CIRCUIT
GREEN	16	TANK LEVEL MONITOR, SPOT- LIGHT
GREEN	10	SPOTLIGHT
GREEN	8	BONDING

Note: The list above applies to a number of vessels. Vessel components/wiring may vary depending on the model.



(AC) ALTERNATING CURRENT-GENERAL INFORMATION

OVERVIEW

Alternating current sometimes called AC current is brought on board through the use of a dockside shore-power) cord. Just as a residential home uses 120/240 volts to run various household appliances and equipment the same holds true on your cruiser.

With AC current, electrons “cycle” in one direction a short distance and reverse themselves traveling in the opposite direction. This is how AC became known as alternating current.

The rate that the current reverses itself is referred to as frequency. In the United States the alternating current frequency is 60 cycles per second. Overseas a 50 cycle frequency per second is standard. Component specifications must match the country’s frequency.

BASIC ELECTRICAL TERMS

Voltage is a measurement of the electrical potential that an electrical power source contains for doing some type of work for us. Think of it as electrical pressure. An example might be your boat’s battery.

Amperage is a particular amount of electricity flowing through some part of a circuit. Think of amperage as the rate of electrical flow through your boat’s wiring.

Resistance inhibits the electrical flow through a circuit and is measured in ohms. An example would possibly be an incandescent light bulb. The resistance in the light bulb element allows it to glow and brighten the cabin along with giving off heat.

It is important that you understand and respect the alternating current system used on board. **Be sure to read and follow any danger, warning, or caution labels in reference to the boat’s electrical system or individual equipment components. Read all vendor supplied literature in the owner’s information packet. Most of all, use common sense!**

ALTERNATING CURRENT LOAD MANAGEMENT

Alternating current brought on board through the shore power cord dockside must be managed to achieve the most from the limited power available. It is completely opposite from our homes where available voltage, numerous breakers and an abundance of circuits serve an almost unlimited supply of appliances, lights and other components.

As you activate sub breakers at the main ship’s panel some desecration must be used. Monitor the load current (amperage) meter at the top right side of the main ship’s panel.

Note: In some cases it may be necessary after running the air conditioner awhile to turn the thermostat to the “fan” position before attempting to activate other breakers on the same shore circuit. This will shutdown the compressor motor but the system will still circulate cooled cabin air for a temporary period. This procedure will provide more available amperage for other selected components while the air conditioner system is in the “fan” mode.

DOCKSIDE (SHORE POWER) CORD SYSTEM

The dockside cord is the basic component used to deliver 30 amps of electrical power from the marina dock feed box to the boat itself.

Before plugging in the dockside power cord to the vessel check to see that all vessel AC breakers are off. This includes the incoming as well as both the main and equipment breakers at the AC ship's control panel. See the AC panel illustration later in this chapter.

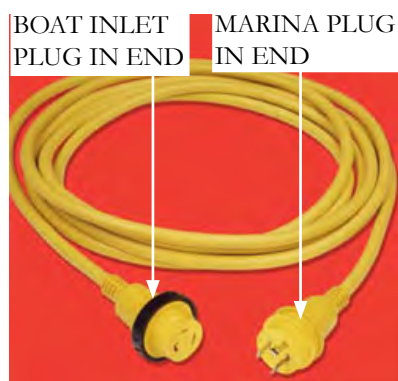

TYPICAL 30 AMP CORD

When connecting the shore power cord be sure to twist the cord into the boat inlet plug first. The inlet plug is located on the port deck. The cord installs one way only. Align the 2 pins with the 90 degree shape, (or use the imprinted arrows and detentes located

on the inlet plug) insert the cord end straight into the inlet plug and twist in a clockwise direction to lock in place. Screw the threaded sealing ring into the shore power inlet until tight. This protects the inlet and cord pins from moisture and possible corrosion build-up.

Shore power is optional. A 30 amp shore power inlet plug is standard equipment with this option.

When not in use close and turn the covers until tight to prevent moisture from entering the plug.



TIPS-MARINA SHORE POWER STATIONS

As you become a more experienced boater you may engage in longer cruises with over night stays. It is most frustrating after a day of hard boating to pull into a marina and find your shore power cord does not adapt to the marina shore power station. This may be especially true stopping at older marinas built before the 1978 National Electric Code was enacted for these facilities. Therefore, it is recommended that you purchase several shore power adapter cords to meet various marina plug footprints.

Carry an extra 125 volt/15 amp adapter with a female twist 3 prong plug to a straight blade male plug with a locking screw.

A point to remember is that sometimes a chart plotter will provide local cruising information including marinas and facilities they offer but normally they do not provide the power voltage available at dockside.

Remember that your boat's main ship's panel features a reverse polarity indicator. Be sure to read that section in this owner's manual chapter since plugging into a marina distribution system is where you can find some strange wiring especially at older facilities.

Your boat shore power cord may utilize a LED light system located at the male plug end. When you plug the cord into the dock receptacle the LED light should show **green** indicating the current is "on". If the LED light shows **red** there is incorrect wiring at the power site. Contact marina personnel immediately.

Plug the shore power cord into the marina dock power box last. This reduces the possibility of a shock hazard. Be aware there may be several types of inlet plugs located at a marina dock power center and you must be able to figure out which ones are adaptable to your vessel.

When running the shore power cord use stand-offs such as clips or Velcro straps to hold the cord from touching the water. These clips or straps can be fastened to a rail or other components. In tidal zones provide for low and high tide swings. Always review the power cord layout to provide a safety zone from the water.

Also, marina dock power centers normally have breakers that must be activated after installing the dockside cord. Check with the marina dock master for more information on their shore power operation and requirements.

Before attempting to disconnect the shore power cord turn off all equipment and main AC breakers on the ship's main control panel to prevent any component damage.

When disconnecting the shore power cord first turn the breaker to the "off" position at the marina dock power center. Then remove the dockside cord from the marina outlet. Always remove the cord from the boat's power inlet last. Roll the cord neatly and store it in a dry environment.



TYPICAL MARINA SHORE POWER STATION

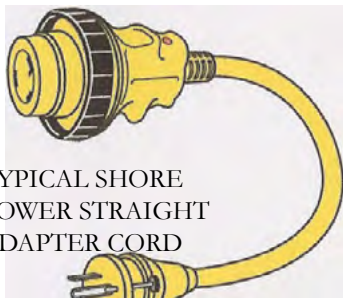

TYPICAL SHORE POWER STRAIGHT ADAPTER CORD

Note that normally it is more likely to find a wiring problem at older facilities usually located off the main waterways where grounding problems exist or where hot wires/neutrals and even grounds are reversed although it can happen at any facility. Any of the above situations may result in your boat shore power system going from polarized to unpolarized with a potential for a fire and personal injury. Know the warning signs such as reverse polarity indicators, main power inlets or if installed ELCI breakers tripping. Contact marina personnel immediately should dock receptacles/plugs trip your on board shore power system or as explained above the red LED light shows on the shore power cord when plugged into the marina plug.

Typical domestic 30 amp dockside cord (sometimes called the shore power cord) usually contain three wires;

Black-ungrounded conductor containing 120 volts

White-neutral ungrounded conductor

Green-grounding conductor



DANGER

**PREVENT BODILY INJURY, DEATH OR FIRE!
NEVER USE EXTENSION CORDS
OR IMPROVISED CORDS
IN SHORE POWER/MARINA INLETS.
USE ONLY APPROVED MARINE
SHORE POWER CORDS
MATCHING THE ORIGINAL
WIRE GAUGE AND AMPACITY .**



WARNING

**PREVENT SEVERE INJURY OR DEATH!
ALTERNATING CURRENT (AC) CAN KILL YOU!
DISCONNECT
ALL ELECTRICAL POWER SOURCES
BEFORE ATTEMPTING
TO REPAIR OR REPLACE
ANY ELECTRICAL COMPONENTS.**



POSSIBLE PROBLEMS/SOLUTIONS

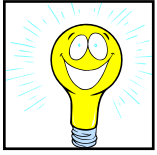

1. After the dockside cord is hooked up to the boat and the marina dock power center and the AC ship's panel main breaker for shorepower is activated no voltage is shown on the main panel AC volt meter.

Check the breaker on the marina dock power center to ensure it is activated.

Check the main breaker/voltage sensing device. The "power" icon should show green.

Check the ELCI main breaker/voltage sensing device. The power icon should show green. If a leakage fault exists a red icon will light indicating the breaker is "tripped". Use the test button to reset the breaker after the condition has been rectified.

Notify marina personnel to verify power and correct polarity at the dock distribution center.

TYPICAL ELCI SYSTEM

TYPICAL ELCI SYSTEM OVERVIEW

The shore power terminates at the power inlet. At this point electricity when energized travels through a main ELCI breaker with leakage fault technology to the ship's main AC control panel with shore power main and auxiliary equipment breakers. The ELCI is located between the shore power inlet and the ship's main AC panel breakers.

After the shore power inlet AC electricity travels to each of the ELCI breakers. The ELCI single pole breaker is set up to trip should an overload or fault occur between the breaker itself and the main AC control panel. If the 30 amp ELCI breaker trips find the cause of the problem before resetting the breaker.

The ELCI stands for "Equipment Leakage Circuit Interrupter". There are two potential failures in a boat's electrical system that can put people on or around a vessel at risk of lethal electrical shock. In a properly functioning marine electrical system, the same amount of AC current flows in the hot and neutral wires.

However, should electricity "leak" from this intended path in these two wires to ground, this condition is referred to as a "ground fault". An example of this is an insulation failure in the wiring of an appliance.

Furthermore, a ground fault can occur when the grounding path is broke through a loose connection or broken wire. As an example a shore power ground wire may fail due to fatigue caused by constant motion and stress. Faulty grounds can go undetected; a simple continuity test may not reveal problems.

When these 2 conditions occur at the same time, it may produce tragic results. The combination of a "ground fault" and a faulty ground could result in the metal parts of the vessel and underwater gear to become energized. If this condition exists, besides being a hazard to personnel on board there is increased danger to swimmers near the boat. The result could be shocking people on board and swimmers could receive a paralyzing dose of electricity and drown due to loss of muscle control.

An ELCI provides protection for the entire boat and features a trip threshold which provides ground fault protection for the entire shore power system beyond the ELCI. The ELCI protection on individual shore power lines combined with GFCI'S will reduce the risk to those on the boat, dock, and in the water surrounding the vessel.

Another feature of the ELCI is a "leakage fault" detector located on the side of the ELCI breaker itself. The leakage fault feature detects a change in the neutral wire current. Should the current change more than 30 milli-amps or about 1/3 of an amp the unit senses the difference and will "trip" the breaker causing the leakage fault LED to illuminate red. This clearly indicates that the trip occurred as a result of leakage. Before resetting the ELCI breaker determine the cause of the leakage fault.

A proper operating alternating current system will display a green illuminated LED at the "power" marked area of the ELCI.

Periodically test the ELCI by depressing the "test" button. The breaker should "trip" indicating the system is functioning properly. Simply reset the breaker. The leakage hazard helps prevent serious equipment damage and possible fire.

After the neutral and the 2-120 volt conductors exit the ELCI they run directly to the ship's main AC control panel.

The ELCI can at times undergo a process called "nuisance tripping" which can cause a "tripped" breaker. This can be caused by overloads in the electrical draw or sometimes caused from unbalanced loads. One way to minimize the situation should it occur is to monitor closer the energized devices on the vessel which will assist in keeping the total amperage used to a minimum and the loads between panel legs more balanced.

Note: It is always a good practice to keep the AC panel legs as balanced as possible and always turn off breakers not in use. Your vessel is not like a home with unlimited energy resources. Remember to balance panel loads.

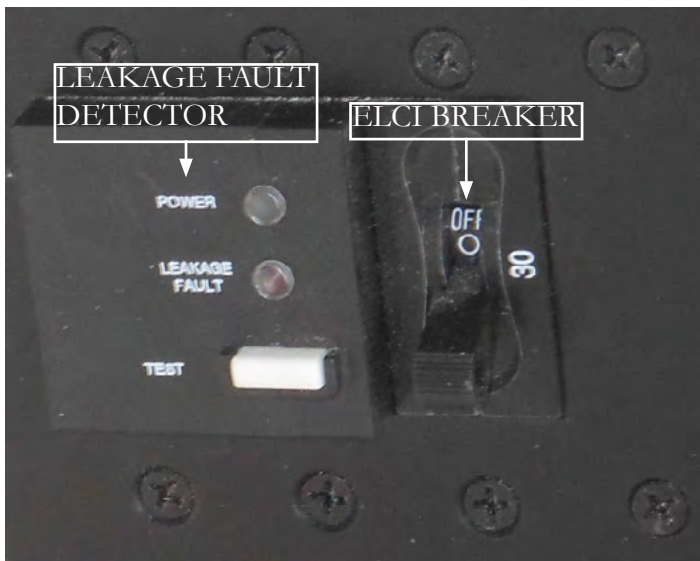

ELCI LEAKAGE FAULT DETECTOR LED INFORMATION

As a central segment of the ELCI system there are two LED lights with a “test” button located at the shore power inlet. With the breaker in the ‘on’ position and the shore power cord hooked up these LED lights may show variations in color to provide system conditions.

They are:

1. Green LED On- Red LED Off

Line voltage is present, the breaker is closed, and the device is protecting the circuits against over current and leakage current.

2. Green LED Off, Red LED On

The device has detected leakage current and has opened the circuit breaker.

3. Green LED flashing, Red LED Off

The circuit breaker has opened due to over current or has been manually turned to the “off” position.

4. Green LED Off, Red LED Off

Line voltage is not present. Check cord connections and marina breaker for “on” position.

5. Green LED flashing, Red LED Off, Amber LED On

Indicates hot and neutral are reversed and the circuit breaker is open.

Note: Check circuit at least monthly by pushing in the white switch marked TEST. When depressed, the breaker should return to the reset position indicating the ELCI circuit is operating properly.

For further information on the ELCI PC-S refer to the vendor (Carling) web-site. Both shore power 1 and 2 use the same testing procedure.

TYPICAL ELCI AC CIRCUIT FLOW CHART

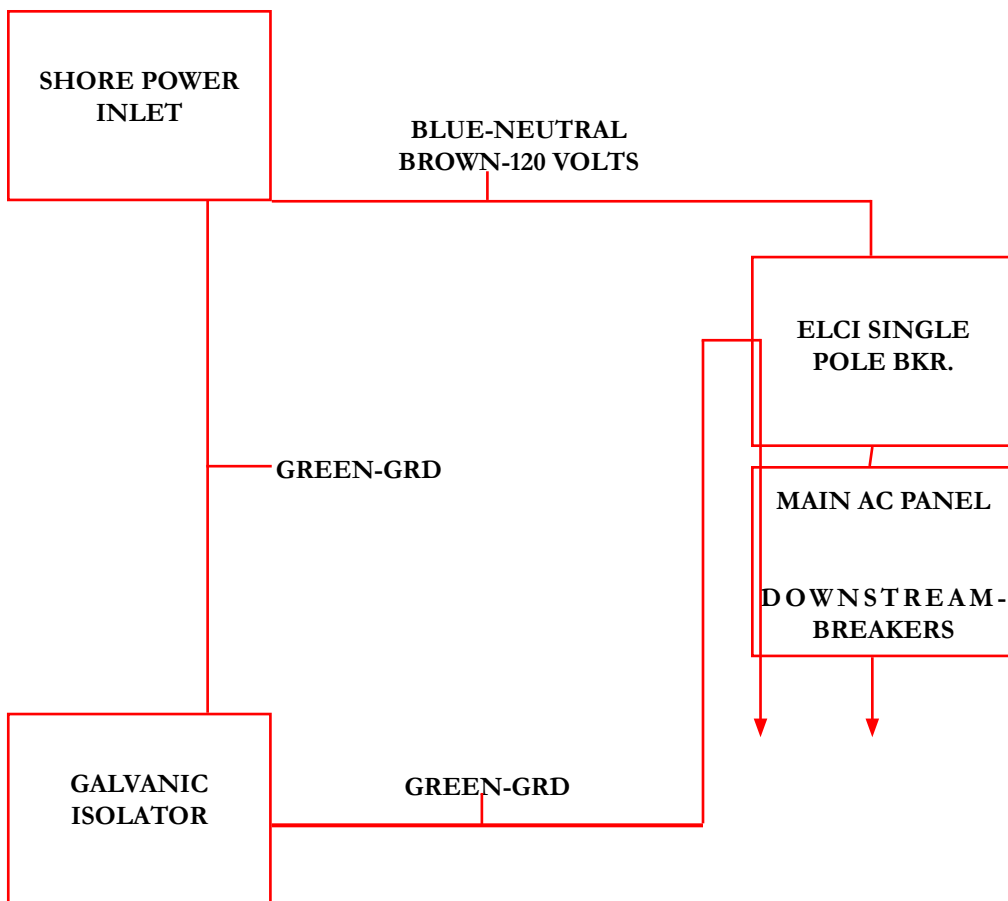



TYPICAL GALVANIC ISOLATOR

As part of the AC boat circuitry the green ground wire takes a different path from the conductors. It enters via the boat's shore power inlet and travels to a galvanic isolator. See the illustration.

A 60 amp (60 hertz) galvanic isolator for domestic use is connected in series with the AC grounding "green" wire. Overseas boats use a 30 amp (50 hertz) galvanic isolator. The purpose of the galvanic isolator is to isolate the



boat's grounding system electrically from the dock and other vessels below 1.4 volts but to maintain a connection to the shore green ground at high voltage potentials. The

low voltage isolation will prevent the vessel's zinc from protecting the underwater metal hardware on another vessel sharing the same AC common green ground wire. This eliminates the possibility of galvanic interaction from other boats on the same dock circuit and permits your anodes to protect your boat. The green ground or "bonding wire" runs from the boat's shore power inlet to a galvanic isolator stud. From the other stud of the galvanic isolator it runs to the AC ground buss located behind the AC main ship's control panel in the salon. Note that the stud nuts must be torqued and maintained at 8.8 inch pounds.

Since the galvanic isolator is not polarized either terminal can be used for the inlet or outlet side for the green grounding wire.

There is a fan located at the right side of the isolator identified by an array of ventilation holes. If you ever hear the fan running the **isolator has failed**. Disconnect the shore power from the boat and check the system. Call your closest Regal dealer for more information.

Do not store objects close to the isolator that might inhibit air flow to the fan.

Note that the galvanic isolator system is also used in boats using the 50 amp main breaker (no ELCI). Normally the galvanic isolator is found in the engine room sometimes called the bilge or sump.

TYPICAL ISOLATOR WIRING

Warning: It is extremely dangerous to swim or be in the marina water due to potential AC current that may be present. Take all necessary precautions as this may be life threatening.

Caution: This device does not provide a status monitor. Following a lightning strike this unit may not continue to provide galvanic isolation protection.

Warning: The fan will operate only when there is a fault to ground and the isolator is conducting electricity. If you notice the fan running immediately disconnect the shore power and contact a qualified marine electrician to isolate and repair the problem with the vessel or the shore power connection. Never cover the fan holes.

Caution: Never test the isolator. Troubleshooting galvanic isolators shall be done by qualified personnel only.

TYPICAL MAIN AC PANEL METER/SWITCH FUNCTIONS

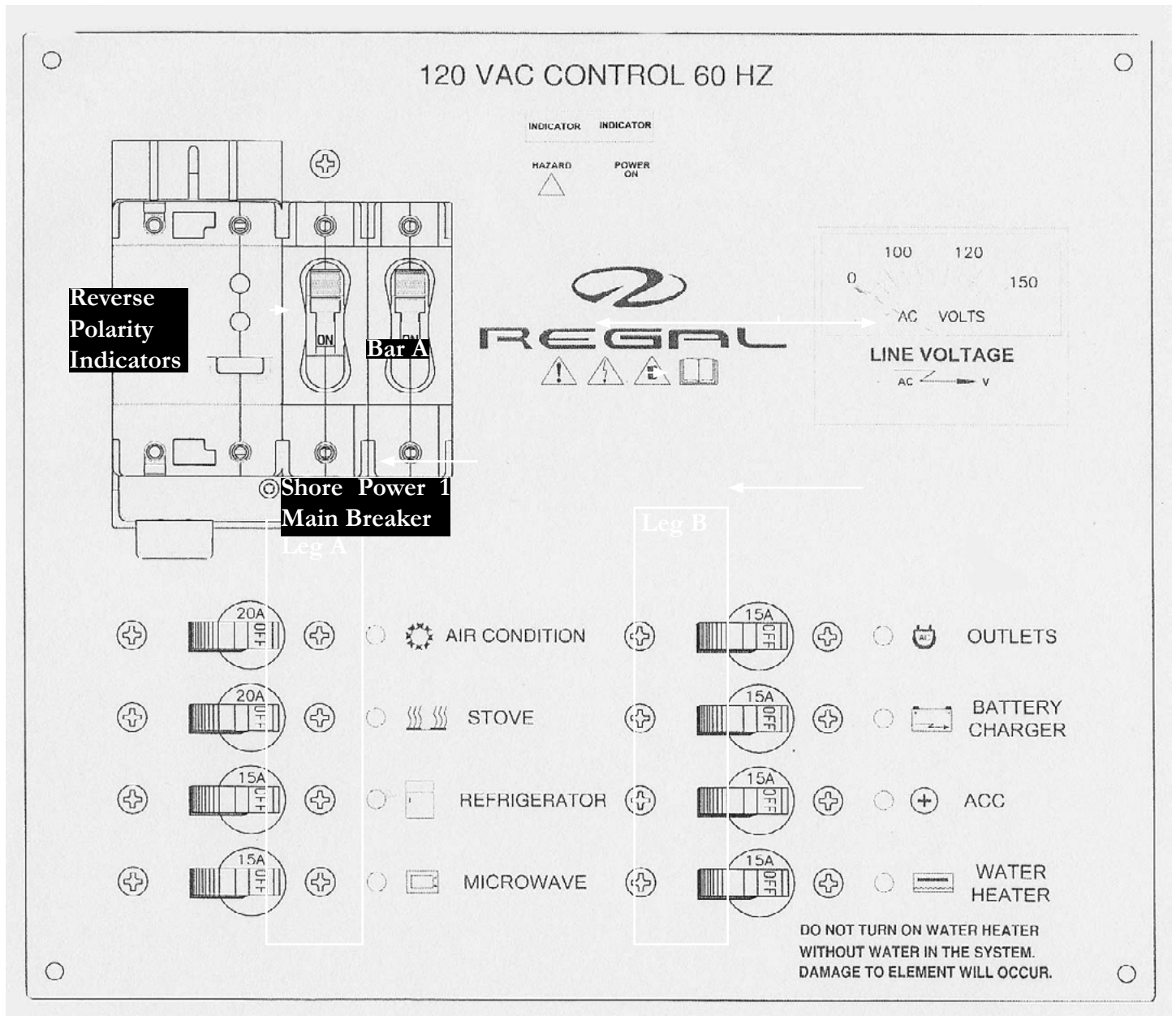

The typical main AC 120 volt control panel is located in the main salon. The main call outs on the panel will be addressed. This panel serves as the main distribution for the incoming shore power from the marina power center. The ship's main DC panel is located along side of the AC panel. Information on the DC panel is found earlier in this chapter.

SHOREPOWER PANEL DISTRIBUTION

As noted earlier the shore power cord delivers AC electricity through the boat's shore power inlet. The AC current travels through the vessel's electrical system to the main AC 120 volt control panel. The AC electricity is now ready to be distributed to the various equipment components.



TYPICAL AC MAIN AC CONTROL PANEL

REVERSE POLARITY INDICATOR

Before activating the AC panel main breaker visually check for a green light at the reverse polarity indicator. The green light indicates there is no reverse polarity. If the red light appears on the reverse polarity indicator a hot wire and ground may be reversed somewhere in the circuit from the dock to the main panel or there may be an over current condition.

In all cases do not activate the main panel breaker. Take immediate corrective action to find the cause of the reverse polarity situation. At this point, disconnect the shorepower cord from the marina power center and call for professional assistance.

PANEL MAIN BREAKERS

The main panel 30 amp breaker deliver electricity through a system of sub breakers to the entire boat. Turn any sub breakers found “on” to the “off” position. This prevents any excessive equipment motor draws and may eliminate any system arcing.

With the reverse polarity indicator showing the green icon, activate the main breaker by pushing the single throw arm to the on position. Notice that each breaker is marked with the on and off terminology, AC electricity now is distributed to the 120 volt leg B of the panel. Follow the same procedure for the main breaker for leg A.

Turn on sub breakers as needed always being conscious of the load current meters..

LINE VOLTAGE/CURRENT METERS

After the shore power 30 amp main breaker is activated line voltage will display on the line voltage meter of the main panel. As equipment breakers are activated the load current meter (extreme right side of panel) will show an amperage draw. Normally the amperage will ascend as more equipment breakers are activated and will descend as equipment breakers are deactivated.

As equipment breakers are activated the load current (amperage) meter will ascend and descend as equipment breakers are deactivated.

As a general note on equipment breakers when leaving the boat it is recommended that most breakers be turned off.

It may be necessary to leave the battery charger on during extended periods and the salon refrigerator. Since the refrigerator is dual voltage (12 and 120) make sure the DC refrigerator breaker is activated and the AC refrigerator breaker is deactivated upon leaving the vessel.

120 VOLT MAIN PANEL BREAKER DESCRIPTION (TYPICAL)

Leg A

Air Condition- This 20 amp breaker controls the conditioning unit.

Stove- This 20 amp breaker controls the galley stove.

Refrigerator- This 15 amp breaker controls the galley refrigerator. This unit is dual voltage which means it can run on 120 volts AC or 12 volts DC electricity. See the note on the previous page regarding leaving the yacht with the refrigerator in the operational mode.

Microwave- This 15 amp breaker controls the galley overhead microwave.

Cockpit Grill- This 30 amp breaker controls the salon (main stateroom) entertainment center.

Sat TV Antenna- This option is currently unavailable on this model.

Leg B

Outlets- This 15 amp breaker controls the 120 volt GFCI and outlets downstream.

Battery Charger- This 15 amp breaker controls the optional battery charger. It is recommended that when leaving the boat for extended periods this breaker be left energized in order to keep the ship's batteries in a charged condition.

Acc.- This 15 amp breaker controls the cockpit ice-maker unit.

Water Heater- This 15 amp breaker protects the hot water heater installed in the engine room.



TYPICAL AC WIRE USAGE	
GAUGE	FUNCTION
6/4 Romex Boat Cable	Generator Output
6/4 Romex Boat Cable	50 Amp Service
10/3 Romex Boat Cable	30 Amp Service
10/3 Romex Boat Cable	A/C Main Power Supply
10/3 Romex Boat Cable	Stove Power Supply
14/3 Romex Boat Cable	A/C Pump, Power Pump Relay
14/3 Romex Boat Cable	Receptacles, Microwave, Water Heater, Refrigerator, Ice maker, Central Vacuum System

 WARNING
TO PREVENT POSSIBLE ELECTRICAL SYSTEM DAMAGE OR FIRE DO NOT TRY TO ACTIVATE SHORE POWER MAIN BREAKERS IF REVERSE POLARITY LIGHT IS DISPLAYED.

GFCI Outlet

Sometimes current in a circuit escapes its normal route and finds a “ground fault”. If that vehicle ends up to be your body and the current passes through your heart the results could be deadly.

A ground fault interrupter or GFCI senses the difference between the hot and neutral wire current before a fatal dose can be conducted and in a fraction of a second cuts the current.

The GFCI devices used in homes are normally not ignition protected. Regal GFCI's are ignition protected.

Your boat uses 120 volt receptacles. By using a GFCI as the first receptacle in the circuit all the receptacles down stream on the same circuit are protected by the initial GFCI. This is accomplished by attaching the hot wire to the line terminal of the GFCI receptacle and the out-going hot wire to the load terminal. The neutral wires also use line and load terminals on the opposite side of the GFCI receptacle.

You can identify the GFCI primary receptacle by the test and reset breaker in the center of the device. Check the GFCI protection monthly. If a problem develops with the GFCI circuitry call a marine electrician to access the situation.

The GFCI outlets are especially useful when electrical equipment is employed such as a drill or in the head with the use of personal devices such as curlers and hair dryers. Never use any electrical devices when puddling water is present to prevent a possible shock hazard.

TYPICAL GFCI (GROUND FAULT CIRCUIT INTERRUPTER)

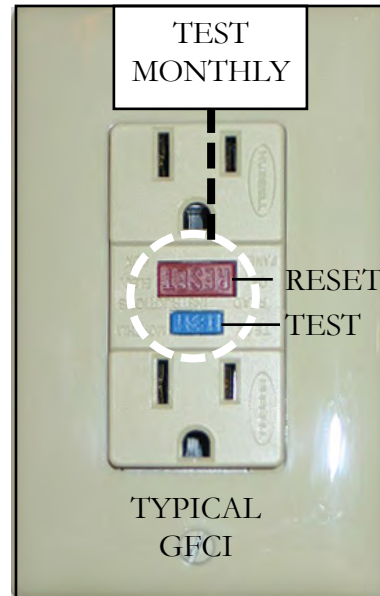

The GFCI is programmed to protect a person from line to ground shock hazards which could occur from various electrical devices operating off of the device or receptacles down stream. It does not prevent line to ground electric shock, but does cut down the exposure time to a fraction of a second before the device trips. It does not protect people against

line to line or line to neutral faults. Also, it does not protect against short circuits or overloads; this is the circuit breakers job.

All GFCI's should be tested monthly to make sure they and the receptacles they protect “downstream” are protecting against ground-faults.



Testing GFCI'S

To test a GFCI find a 120 volt night light or small lamp to plug into the GFCI outlet. Try it in another circuit first to make sure it lights.

After the lamp is plugged into the GFCI outlet the lamp should light. Now press the “test” button at the GFCI receptacle center. The GFCI’s “reset” button should pop out and the lamp should go out. This means the GFCI itself is functioning properly. Press the “reset” button to restore power to the outlet. *Test each GFCI circuit monthly.* You can use the lamp to check receptacles downstream from the GFCI. All receptacles should light the lamp and should go out when the “test” button is pressed.



Also, GFCI downstream receptacles can be tested with a plug-in type GFCI tester. This tester contains a GFCI test button which accomplishes the same thing as the GFCI receptacle built-in test button. This tester can be purchased at electrical supply houses or marine retailers.

Ignition Protected Devices

Many electrical devices in everyday use tend to “arc” or spark when being used. These include motors, fans, switches, relays, etc.

Boats in general use many of these same devices but they are protected from any sparking that may cause the device to ignite with any vapors that are typically found in the engine room and/or fuel tank compartments.

When replacing any electrical device especially in the bilge or engine room make sure it is ignition protected. This means it has been tested and normally the device is stamped with a marking making it safe to use. Most automotive type devices are **not** ignition protected especially engine starters and alternators.

POSSIBLE PROBLEMS/SOLUTIONS (GFCI'S)



1. If the “reset” button does not pop out, the GFCI is probably defective and should be replaced.

2. If the “reset” button pops out one time but tends to stick the next the GFCI should be replaced.

3. The GFCI “reset” button pops out when something is turned on. This may indicate an internal wiring problem with the GFCI or there may be a ground-fault downstream.

4. The GFCI “reset” button is in the pressed position and nothing works. Check the appropriate breaker at the main ship’s AC control panel to make sure it has not “tripped” or as been deactivated.

TYPICAL AIR CONDITIONING SYSTEM

Overview

The typical optional air conditioning system is rated at 7 K featuring a total output of 7,000 BTU's/hour (British Thermal Units) at 120 volts domestically and 240 volts internationally. The system utilizes a single 230 volt pump which delivers cooler seawater to the evaporator/condenser. Warmer seawater exits the boat through a manifold and various thru-hull fittings.

The evaporator/condenser unit incorporates a compressor located under the forward berth bunk to compact the R-22 refrigerant.



The Elite control panel (thermostat).

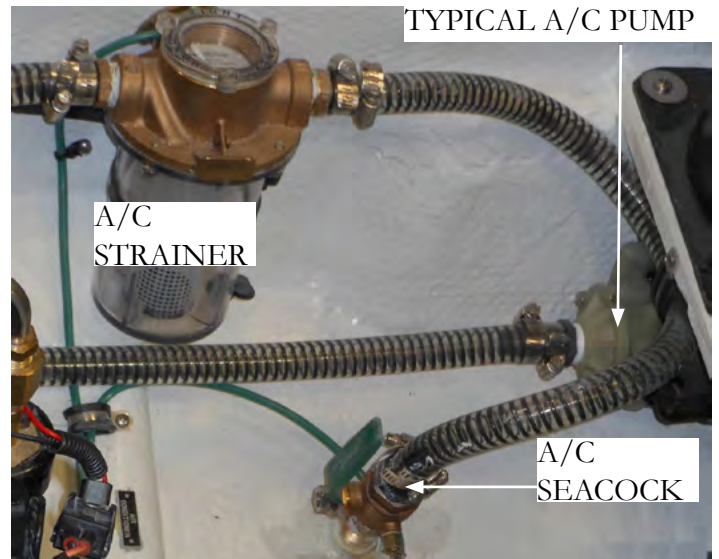

NOTE:

If the vessel is hoisted out of the water (except for winterization) make sure the A/C seacock is turned to the "off" position before lifting the vessel. Failure to do so may cause the air conditioner to loose its prime and the A/C pump may quit on start-up do to a lack of water or cause pump failure. Remember to turn the seacock "on" before re-starting the A/C unit.

TYPICAL AIR CONDITIONING EVAPORATOR/CONDENSER UNIT

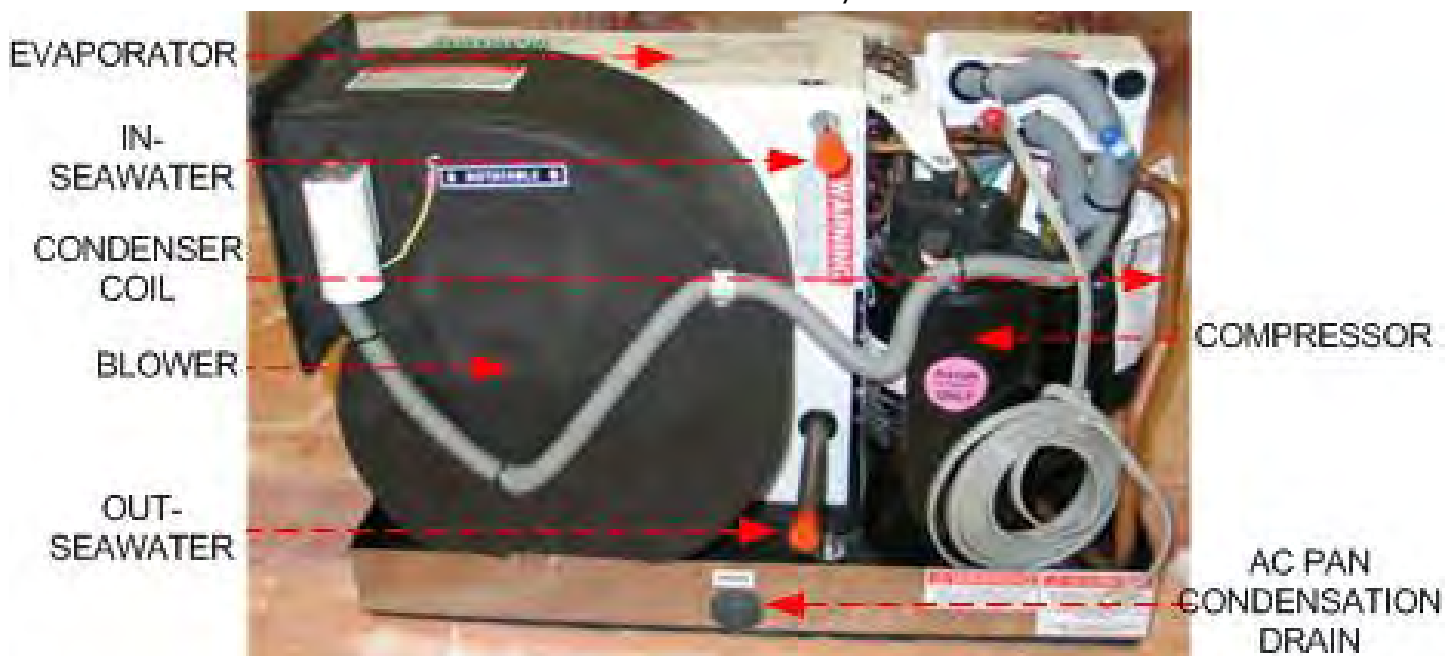



Reverse Heat

Air conditioning systems feature a reverse heat cycle. This can be extremely valuable to boaters in colder climates especially for early spring and late fall cruising.

To accomplish reverse cycle heating, the R-22 refrigerant flows in the opposite direction through a reversing valve located on the evaporator/condenser unit. Heat is transferred from the seawater in the coil of the condenser to the R-22 refrigerant and then to the air as it is blown through the evaporator to the cabin.

Obviously, the temperature of the seawater will effect the air conditioner efficiency.

The temperature variance for cooling efficiency is:

Up to 90 Degrees F. (32.2 Degrees C.)

The temperature variance for heating efficiency is:

Down to 40 Degrees F. (4.4 Degrees C.)

Typical Air Conditioning System Operation

Below is a basic quick start-up checklist for the air conditioning system. **For more in depth information, refer to the vendor operation manual.**

Operations Quick Start-Up Checklist:

1. Check the AC seawater strainer for debris.
2. Make sure the AC seawater pump seacock located in the engine room is opened completely (handle should be in-line with the hose).
3. Activate the forward air conditioner breaker on the boat's main AC control panel located in the starboard aft salon overhead cabinet.
4. Check the hull side for a steady stream of seawater. Seeing water here is normal when the AC pump is running. If stream is diminished or no water emits from the fitting immediately turn the AC pump off and investigate the cause of the problem.
5. Press the Elite thermostat Power button once to activate the air conditioning system. A blank screen displays when system is off and indicates present cabin temperature.
6. For cooling or heating press and release the Mode button until the desired LED is illuminated ie; automatic mode.
7. Press the Up or Down button to set the desired cabin temperature. To view the set point, momentarily press and release the Up or Down button.
8. Auto fan LED lights when Auto fan speed is selected.

TYPICAL ELITE AC CONTROL DIAGRAM

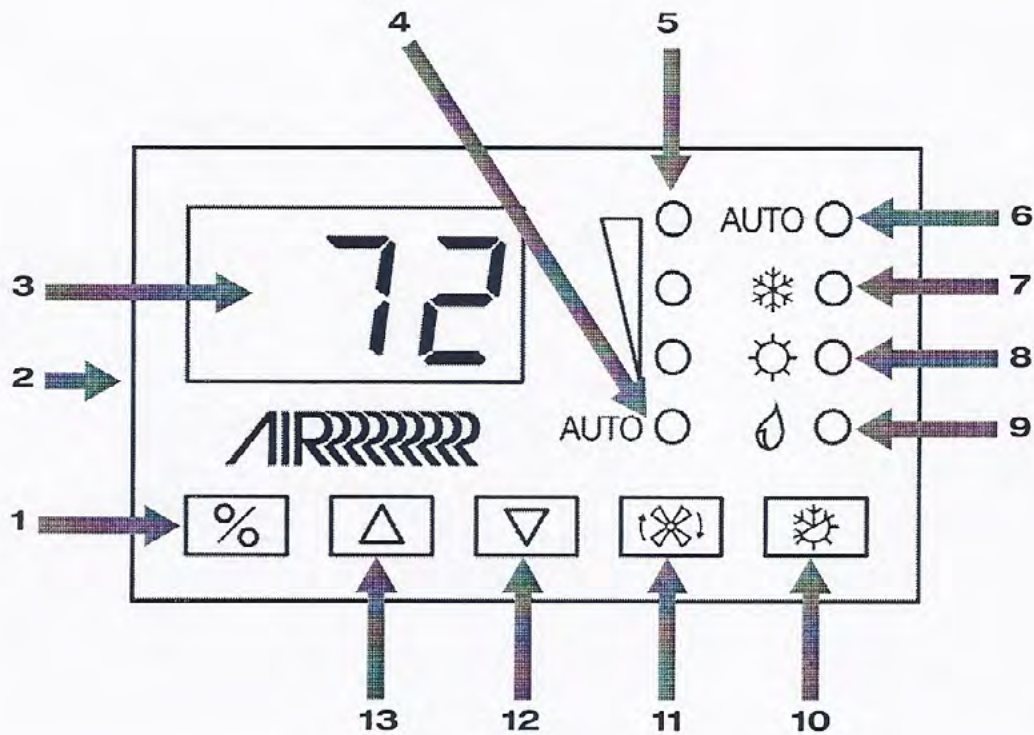

Elite Display - Diagram Legend

1	Power button	8	Heat Mode indicator
2	Temperature sensor	9	Moisture Mode indicator
3	Digital display	10	Mode button
4	Auto Fan indicator	11	Fan button
5	Manual Fan indicator (high, medium, low)	12	Down button - Lower temperature set point
6	Auto Mode indicator	13	Up button - Raise temperature set point
7	Cool Mode indicator		

Note: The Elite display continually monitors the system components. Should a problem develop it sends a diagnostic code to the control (thermostat) display. Refer to the vendor air conditioning manual (troubleshooting section) to assist in identifying the problem.



TYPICAL A/C INSPECTION TIPS

Seawater Strainer

The air conditioner seawater strainer located in the engine room should be cleaned periodically of debris which can



inhibit or stop the fresh sea water supply. Always turn the seacock handle to the off position (90 degrees to the hose fitting) before cleaning a seawater strainer. Remove the basket by turning the plastic cap in a counterclockwise

direction. Set the cap and the O ring aside. Pull the basket from the unit, rinse with water, air dry and reinstall. Sediment at the bottom can be removed by just turning the plug in a counterclockwise direction. Place a container under the strainer to catch the sediment. Coat the O rings with waterproof grease containing a silicone or teflon base. Reinstall O rings along with the plug and plastic cap. Turn on the seacock and check for leaks.

Return Air Filters

Once a month check the return air filter located on the face of the evaporator. To clean rinse with fresh water, air dry and reinstall.

WARNING

**PREVENT SEVERE INJURY OR DEATH!
DISCONNECT
ALL ELECTRICAL POWER SOURCES
BEFORE ATTEMPTING
TO OPEN, REPAIR OR REPLACE ANY
AIR CONDITIONING COMPONENTS.**

Drain Pans

As noted on an earlier page the AC evaporator/condenser features a 2" deep drain pan connected by a hose that runs to a sump pump and eventually exits overboard. Periodically just like your home AC, the pan needs to be rinsed clean of debris and possible mold.

You can use a purchased product made specifically for cleaning AC units. Disconnect the outlet hose from the AC pan and install a made up hose (5/8") that will catch the used solution to fill a small container. Dispose of the container in accordance with federal, state and local regulations. Pour the solution into the pan and allow time for it to drain. Reconnect the original drain pan hose when finished.

Condenser Coil Cleaning

Periodically the condenser coils are recommended to be cleaned. This procedure should be done by a professional since an acid solution must be used.

POSSIBLE PROBLEMS/SOLUTIONS (A/C)

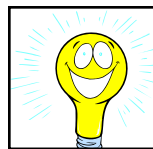

1. No or little water is noticed at the thru-hull fittings and a HPF fault code shows on the display which means the high pressure switch is open.
The strainer or intake hose may be clogged, seacock may be closed a hose may be collapsed or the AC pump may be defective. Check AC pump breaker to verify pump is energized.
2. Air conditioner will not start. Ensure the proper AC breaker is activated on the ship's main control panel.
3. No cooling or heating. Lower or raise set point on thermostat control to offset set point being satisfied. Check for obstructed seawater flow. Remove discharge side of pump hose to purge air (air-lock). Seawater temperature too high for cooling and too low for heating.
4. Fan coil is iced. Raise or lower control set point. Clean return air filter. Switch AC to heat until ice melts or as a last resort use a hair dryer to melt ice as needed.

TYPICAL FRESH (POTABLE) WATER SYSTEM - OLDER VESSELS

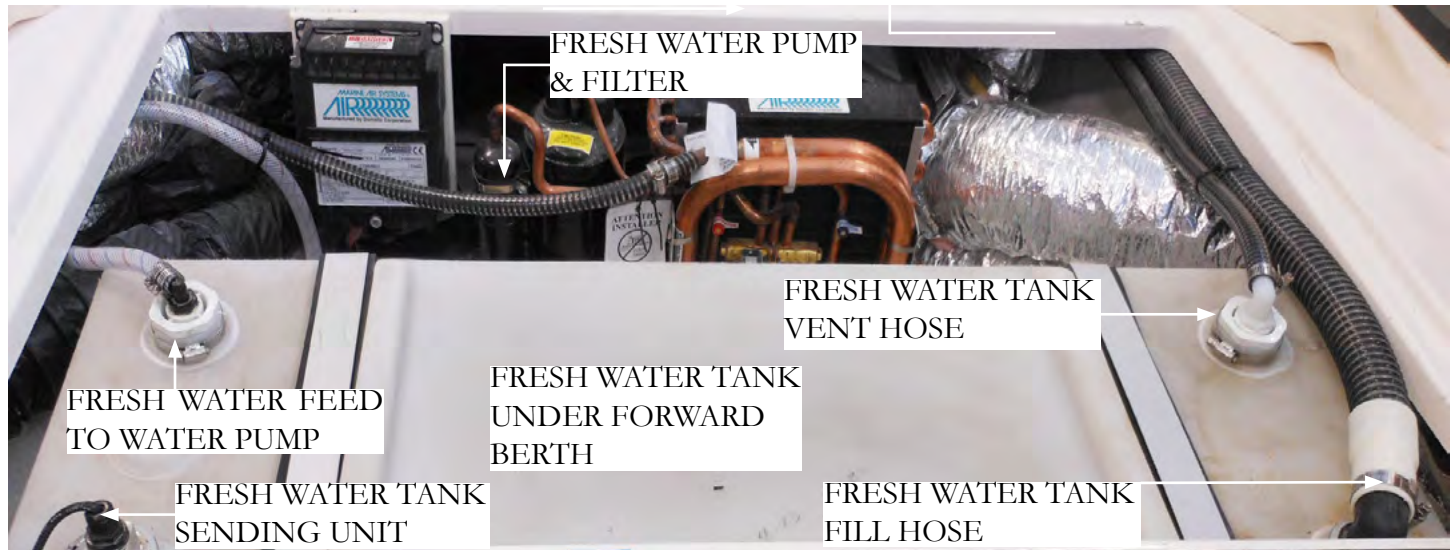

Your vessel is equipped with a fresh water supply system. It consists of a fresh water tank, deck fill/vent fittings, monitor panel, pressure water pump with filter, distribution system, wash-down faucet, and hot water heater. As needed the pressure demand type pump is energized, or the dockside water inlet valve distributes water through the vessel normally bypassing the potable water tank.

The system is winterized from the factory utilizing a product called “Freeze Ban”. It is best to completely drain the Freeze Ban before adding any water to the tank in order to minimize the taste of Freeze Ban. Freeze Ban will not harm you but it does have a peculiar taste.

The system requires little maintenance except occasional flushing and disinfecting the system, cleaning of the water filter and winterizing in cold weather climates.

For more specific information on the water system contact your closest Regal dealer.

The fresh water system, also known as the potable water system uses a tank to distribute water on board.

Note: There are two ways to fill the potable water system. It can be filled using the foredeck water fill. Also, located on the aft cockpit is a dockside water valve which connects to a hose from the marina fresh water supply. There are special white hoses for potable water system filling that are odorless. **Before filling potable water tank disinfect entire fresh water system. Use the Public Health Service Publication information outlined in Chapter 10.**

Filling Water Tank At the Deck Fill

Fill with a clean water system approved hose until you see water emerging from the deck vent. Reinstall the fill cap and use a designed “key” to tighten it.



TYPICAL WATER FILL CAP

Periodically check the water fill cap for tightness. On the underside of the water fill cap is an “O ring” which helps to seal the cap properly. The “O ring”

should fit tightly around the cap. If it is loose, cracked or damaged replace it since it helps to keep debris out of the water system.

For general knowledge all red water lines carry the “hot” water on board your vessel. Likewise, all blue water lines carry the “cold” water.

A special reinforced fabricated hose is used to feed the water pressure pump. The design prevents kinks.

Using Fresh Water System With Tank Only -Newer Vessels

This approach is mainly used while cruising without the ability to draw from a marina or public water supply by attaching a garden hose to the city water valve. Also, use this procedure when you are unsure of the purity and / or source of the water supply for drinking.

1. Verify through the monitor panel that the fresh water tank is full by activating the upper portion of the toggle switch.
2. At the helm switch panel activate the fresh water system switch. This will energize the water pressure pump to send fresh water from the potable water tank through the cold water lines terminating at the various faucets and related components.
3. Open a faucet. Water pressure should be present. Opening the faucet for a few seconds will purge any air in the system especially in cases where the fresh water tank has run out of water. When water is running at a faucet it is not unusual to hear the water pump activate as it is trying to build up the pressure required in the system. Soon after the faucet is turned off the fresh water pump sound will end indicating the fresh water system is now up to specified system pressure.

Note not to run pressure water pump with system dry as water pump component damage may occur.



Using Fresh Water System With City Water Valve



TURN COUNTER CLOCKWISE TO OPEN

Use this procedure when at the dock or mooring.

1. After verifying that the water supply is safe for drinking find the city water valve at aft transom. Remove the cap and inspect screen for debris.
2. Connect a white colored kink resistant garden hose to the city water valve. Turn on the marina water supply and check for leaks at the connection. White garden hoses are the ones rated for fresh water supply verses a regular garden hose that normally leave a rubber smell in the water supply.
3. Repeat steps 2 and 3 as indicated on the last column since the process at this point duplicates itself.

Note that the city water valve protects vessel water system by limiting incoming water pressure to 35 psi's.



Typical Monitor Panel

If installed the water system features a water/waste monitor panel which senses the amount of water left in the potable water tank system. It is located at the ship's main electrical control panel in the aft starboard salon.

To use the panel, press the switch in toward the freshwater tank position and hold. The amount of potable tank water will be displayed. The sender for the fresh water monitor is located on the top of the fresh water tank which is located under the front berth. The key switch portion is used for the optional overboard discharge. Read and understand the section on using the macerator in the waste system before attempting to operate the overboard discharge system.

Laws in many locals prevent the use of overboard discharge. A person could be severely fined so know the restrictions before using the macerator pump-out.



TYPICAL WATER/WASTE MONITOR PANEL

Sanitizing Water System

If the vessel has been in a storage condition or you suspect the water system may be contaminated, then the system should be sanitized.

You can purchase a water treatment kit with ingredients that will sanitize the system. Follow the directions with the treatment kit. If a water treatment kit is not available follow these steps to sanitize the water system.

1. Make sure the water tank is pumped until empty. Shut off the *water pressure* breaker at the 12 volt ship's panel. Do not run the fresh water pump dry.
2. Locate the potable water system disinfection information and chart located in Chapter 10 of this manual.
3. Follow the step by step procedure outlined there using the supplementary chart as needed to mix the ingredients.

NOTICE

Do Not Use Waste/Pump-Out
Before Knowing Laws/Regulations
Regarding Dumping Waste.

Typical Hot Water Heater

Your vessel may feature a hot water heater option. It mixes cold water with recirculating engine hot water with a tempering valve to safety keep the temperature below 130 degrees. The valve incorporates an adjustment valve which can be turned to adjust the water temperature as hot water mixes with cold water running through the system.. There is a one-way valve that keeps the hot water from back flushing into the cold water supply. The hot water heater is located in the engine room.

A 15 amp breaker at the main ship's AC panel controls the water heater circuit. Always test the water for temperature before amercing body parts in it. See auxiliary system chapter for more information.

Typical Shower Sump Pump System

Your boat features a head with a shower usually located under the cabin entry stairway. As part of the drainage system a self-contained shower sump pump collects all water and debris. After the water reaches a predetermined level the float switch permits the pump to send the used shower water to an overboard thru-hull fitting or into a tank depending on the systems onboard.

After showering, always let about one gallon of water settle through the shower drain to help rid the shower, drain, lines, and shower sump pump of possible debris, hair, and mineral deposits.

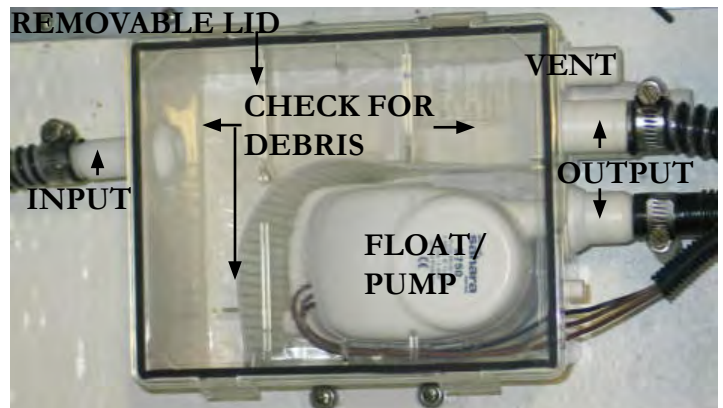

TYPICAL SHOWER SUMP PUMP

Refer to the sump shower hose identification diagram for specific hose routes found earlier in the air conditioner section.



POSSIBLE PROBLEMS/SOLUTIONS- FRESH WATER SYSTEM



1. Fresh water pressure pump cycles on and off. Normally this type of action indicates a water leak in the system. Check all fresh water system related equipment on the deck, cabin, and engine compartment for leaks. Do not forget wash down equipment including spigots. Look for puddled or dripping water.
2. Using potable water system the water pressure is weak. Check the fresh water pressure pump filter for debris. Also, make sure the potable water tank level is sufficient at the monitor panel.
3. Water at sink or shower is hammering and has air bubbles in it. Check for air leaks in the system along with low water levels in the potable water tank.
4. Water is backing up in the shower. Find the shower sump pump. If it is full of water even when running there normally is a clog at the pump screen. Clean as needed.
5. There is no water at any of the fresh water related equipment such as faucets, showers and wash downs. Check to make sure the fresh water pressure pump breaker is on. Also, check the fresh water monitor for tank levels at the salon monitor panel.
6. The water system has a bad odor. Use the fresh water pressure pump to drain the fresh water system. Do not drink the water as it may be contaminated. Sanitize the water system as explained in Chapter 10.
7. There is no hot water. Turn the hot water heater breaker to the off position. Remove the back cover on the water heater and check the reset button. Push to reset. Also, the heating element may of malfunctioned. At this point, call a service technician.

CHEMICAL TOILET

Installed as standard equipment on your vessel is a self-contained sanitation device known as a chemical toilet featuring an upper fresh water tank and a lower deodorized tank. These two components can be separated for waste disposal, cleaning and refilling. The lower tank contains a capacity gauge. Before each outing, check the waste level since it is illegal to dump waste within and extending out to the United States territorial limit.

Refer to a typical system shown on the following page. For more information, review the vendor manual supplied in the owner's information packet or visit the on-line location.

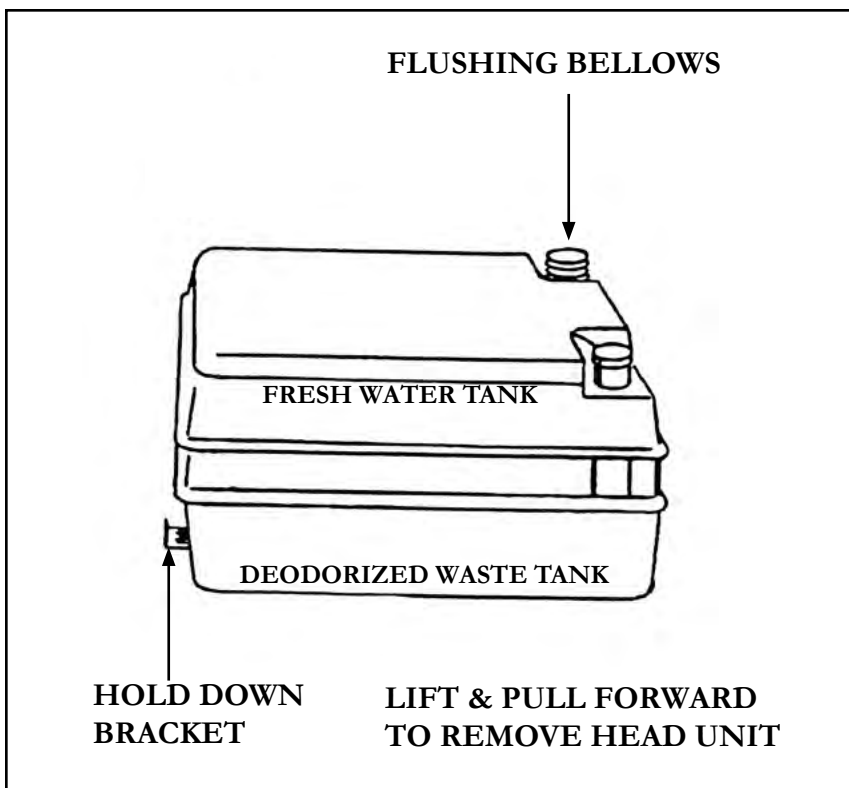



TYPICAL WASTE WATER SYSTEM DESCRIPTION (BILGE LOCATION)

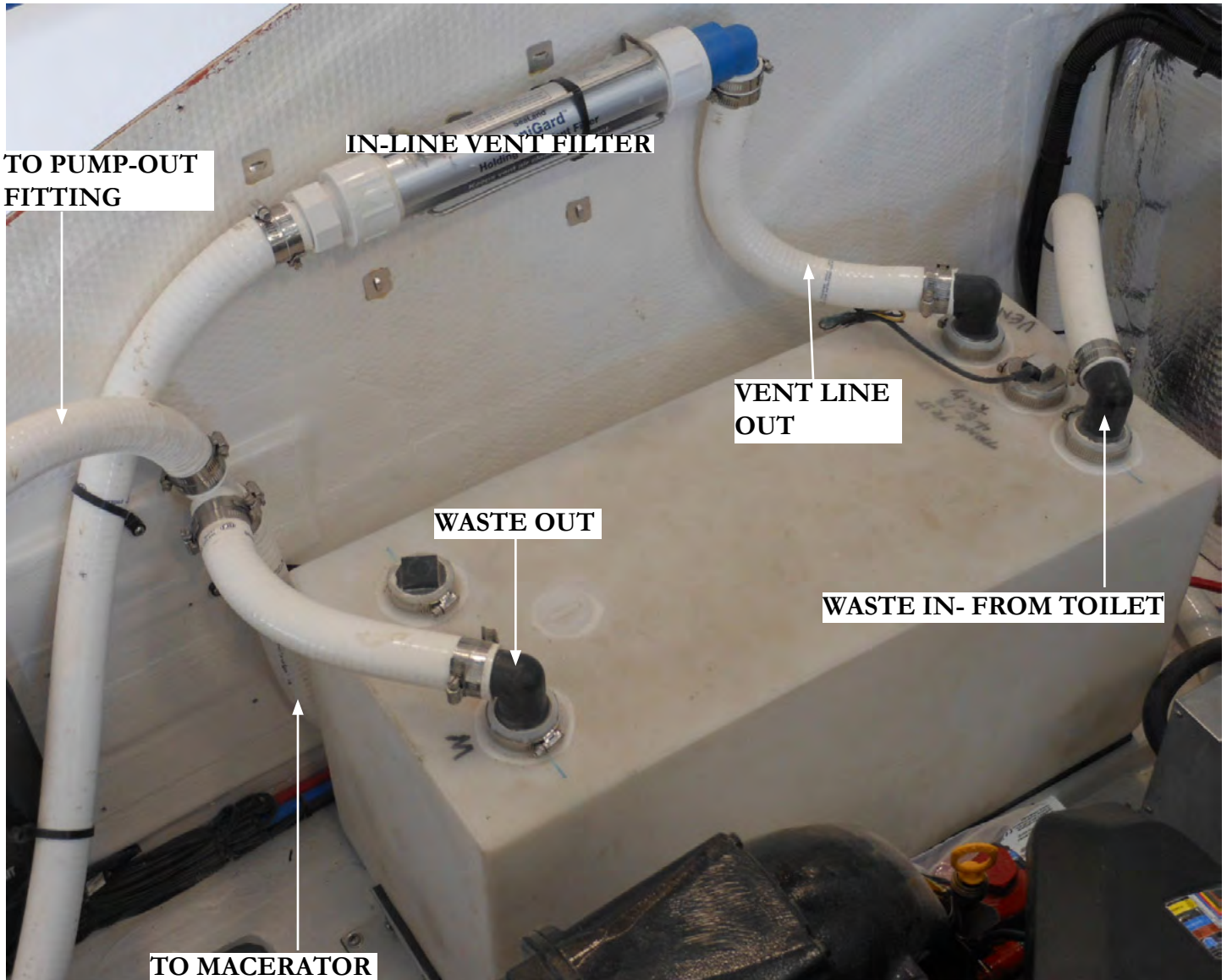

TYPICAL WASTE WATER SYSTEM

Overview

The waste water system on your boat may include a waste tank located in the engine room. Besides the tank the system features a chemical toilet and waste pump-out fitting. A monitor panel shared with the fresh water system displays the waste tank level when activated.

If installed, a macerator (overboard discharge pump) diverts waste through a hull bottom seacock (where dumping laws permit).

TYPICAL WASTE TANK HOSE FUNCTIONS	
EQUIPMENT	FUNCTION
Pump Out	To Pump Out Deck Fitting
Vent	To In-Line Vent Filter
Waste-In	From Forward (Salon) Head
Overboard Discharge	To Macerator (Overboard Discharge Pump) Located In Engine Room

Typical Head (Electric Toilet System (Option))

The optional on board electric head system features a toilet taking advantage of minimal water usage. The system features vitreous china bowl, minimal maintenance, easy cleaning and a wall switch keyboard.

The toilet is powered by 12 volt DC electricity and is controlled by a 30 amp breaker located at the ship's main DC control panel.

Under normal conditions, the head system operates from the onboard fresh water tank. If dockside water is being used the toilets still draw water from the freshwater tank. The head fuse is located on the fuse block inside the galley. Simply remove the waste basket from the galley to access the fuse panel.

A Few Notations About The Head System:

- Only human waste and toilet paper should be put in the toilet. Never flush foreign materials such as paper towels, pre-moistened wipes, condoms, feminine hygiene products, dental floss or household garbage down the toilet.
- Always disconnect the dockside water system if boat is left unattended to avoid property damage due to leakage.
- Refill the toilet as soon as possible after emptying the bowl to prevent objectionable odors.
- Use only RV-Marine toilet tissues that disintegrate rapidly. Do not use household type tissues.
- If repairs are needed, use only a trained and qualified marine technician or electrician.

Using Vacuum Style Toilet

To use the on board toilet first make sure the 12 volt head system breaker is activated at the main control panel. If using dockside water make sure water is connected from the marina spigot (faucet).

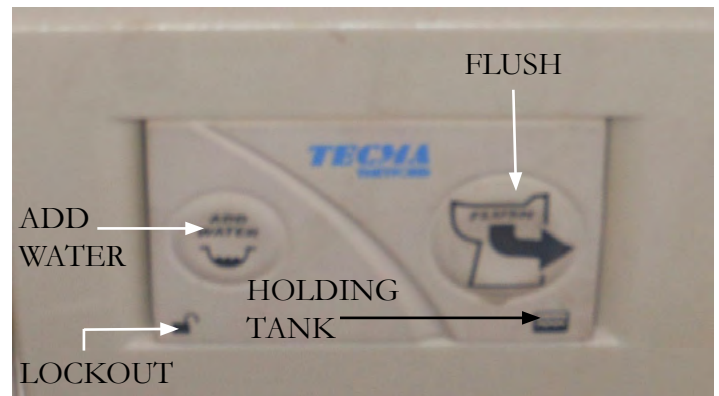

TYPICAL WALL SWITCH

The wall control switch is used to add water to the bowl and to flush the toilet. Select cycle information is noted below. For more complete information, refer to the toilet vendor information located in the information packet.

1. To add water (est. 17 ounces each cycle) to the bowl press the add water button momentarily and release. The system prevents overfilling the bowl.
2. To flush the bowl press the flush button momentarily and release. The attached bowl motor will macerate the waste and flush it. The cycle ends with a small amount of water being added to the bowl to help prevent odors. This completes the minimal water usage flush cycle.



Wall Control Panel Blue Backlighting Description:

- The holding tank icon in the lower right hand corner of the control panel is not lighted. Toilet system is off or not receiving power.
- The holding tank icon is normally green. This means the holding tank is less than full.
- The holding tank icon is red. The holding tank is full or near full with the flush lockout (prevents Flush operation when holding tank is full) activated.
- Tank icon flashes
- Sleep mode (non-use for 8 hours) causes the lights to go out. Pushing the fill or flush button momentarily will return lighting cycle.

Single Flush Override of Flush Lockout

1. If the holding tank is full the flush lockout cycle will not allow the bowl to be flushed and the flush button will be lighted red.
2. For emergency use only the flush button can be held for 8 seconds and a flush will occur. This can be accomplished because the full sensor connected to the holding tank is usually placed a bit below the actual full capacity of the tank. Flushing more than 5 times using the override feature may force waste into plumbing system. **Regal is not responsible for damage to equipment, or injury or death due to overflow of waste due when flush lockout is overridden.** Again, refer to toilet vendor information in the owner's information packet.

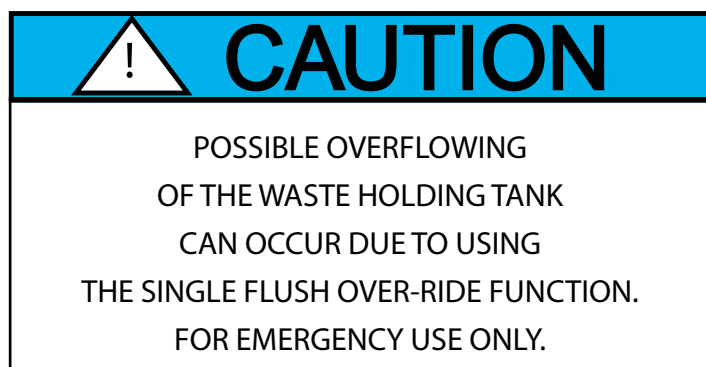

Typical Dockside Pump-Out



There is a fitting located on the deck labeled “waste.” This fitting is used to pump out the waste tank. Normally a pump out station is found at most marinas. After removing the fitting cover a special hose is inserted into the fitting and the machine then removes the waste. Normally there is a charge for the service. Make sure they connect the hose to the “waste” fitting. Of course when cruising in international waters the overboard discharge pump may be used. See the section on using the macerator.

Typical In-Line Vent Filter

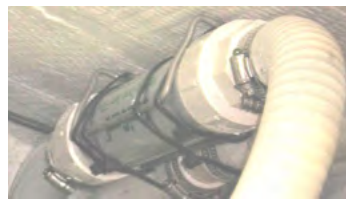

As stated earlier there is a waste filter installed in the *vent* line between the waste tank and the port thru-hull fitting. The filter's purpose is to keep objectionable odors to a minimum from the waste tank. It is recommended that the filter be changed yearly. It can be ordered from your Regal dealer or from marine supply stores. The waste filter is mounted in the sump (engine compartment) near the waste tank.

Gray Water System

If installed, the gray water system is used in areas where dumping fresh water waste products overboard is prohibited. Gray water originates from on board sinks and showers. With this system all the gray water is pumped into the waste holding tank via the shower sump pump system verses directly overboard. The holding tank periodically needs be to be pumped out by a marina pump out station through the “waste” fitting on the deck. Use the waste water portion of the monitoring panel at the ship's main control panel to check waste water levels.

Typical Macerator (Overboard Discharge Pump)



The macerator (overboard discharge pump) option is located in the engine room. It is connected to a normally closed seacock. In locals where it is approved the seacock is **opened** and the

macerator is activated through a key switch and button located at the ship's main salon control panel (shown above). At that point waste travels from the waste holding tank through the macerator pump where it is ground up and then exits through the hull bottom at the open seacock. See the photo.

To Use Macerator (If Installed):

- Make sure it is legal to pump waste overboard before starting the operation.
- Locate the overboard discharge seacock in the engine room. Usually this seacock can be identified by the stack of tie wraps next to it. Also, look for the incoming hose that runs from the output side of the macerator to the seacock. It is normally a 1 1/2" diameter white hose. Since the seacock by law must be have another means besides the handle to keep it closed the tie wrap serves that need. Cut the tie wrap to access the seacock handle.

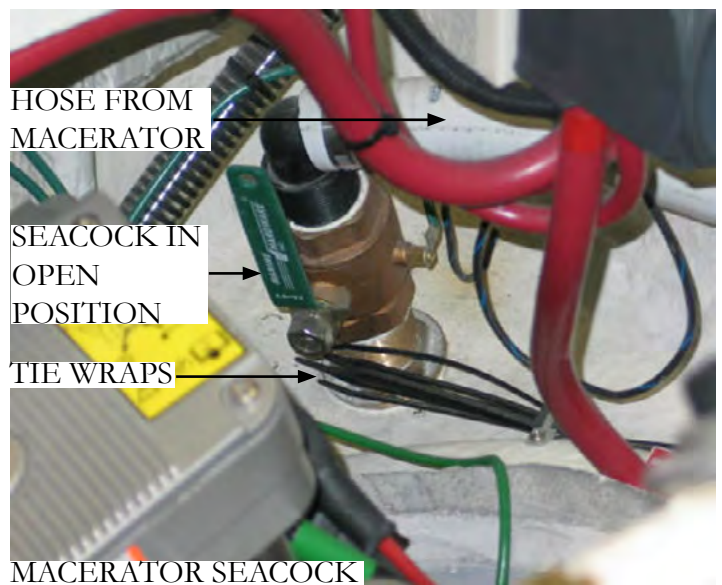

- Turn the seacock handle to the "open" position. It should be positioned in line as shown in the photo.
- Activate the macerator breaker at the 12 volt salon main DC control panel.
- At the level monitor panel shown above turn the key to the "on" position. With the key switch being held in the "on" position push in on the macerator button to start the overboard discharge. Continue to discharge the waste until the monitor panel shows empty for the waste tank. At this point, shut off the macerator switch, deactivate key switch and turn macerator breaker to the "off" position.
- Close the seacock handle. It should now be at a 90 degree angle to the seacock.
- Use a tie wrap and refasten the seacock handle tightly so it can not be moved.
- At this point you may desire to add an approved holding tank deodorant by flushing the correct amount down the toilet.



POSSIBLE PROBLEMS/SOLUTIONS- WASTE SYSTEM-LATER MODELS



1. Toilet does not flush or flushing performance is poor. The holding tank indicator is lighted red at the toilet control panel wall switch. The holding tank is full and needs to be pumped out. Also, there could be a clog at the water pump inlet.

2. No water in bowl during flush or add water cycle. Check to make sure the main water supply has not been turned off along with the fresh water pressure pump.

3. There is no light on the toilet wall control panel or it does not stay lighted. Check the head breaker on the main ship's control panel. Also, the wall panel could of entered the Sleep mode cycle after 8 hours of inactivity.

4. There is an odor of sewage onboard. Check the vent filter. It should be replaced annually at the beginning of the boating season. Also, check the waste tank, fittings, and related hoses throughout the vessel.

5. When running the overboard discharge pump it is not pumping out the waste. Check to make sure the deck waste cap is securely fastened and O ring is not missing (Air in system).

TYPICAL WASTE SYSTEM-VACUUM STYLE MODELS

1. Toilet Bowl
2. Solenoid Valve
3. Fresh Water Pressure Pump
4. System Vent
5. Holding Tank
6. Fresh Water Tank (System can also run from dockside water supply)

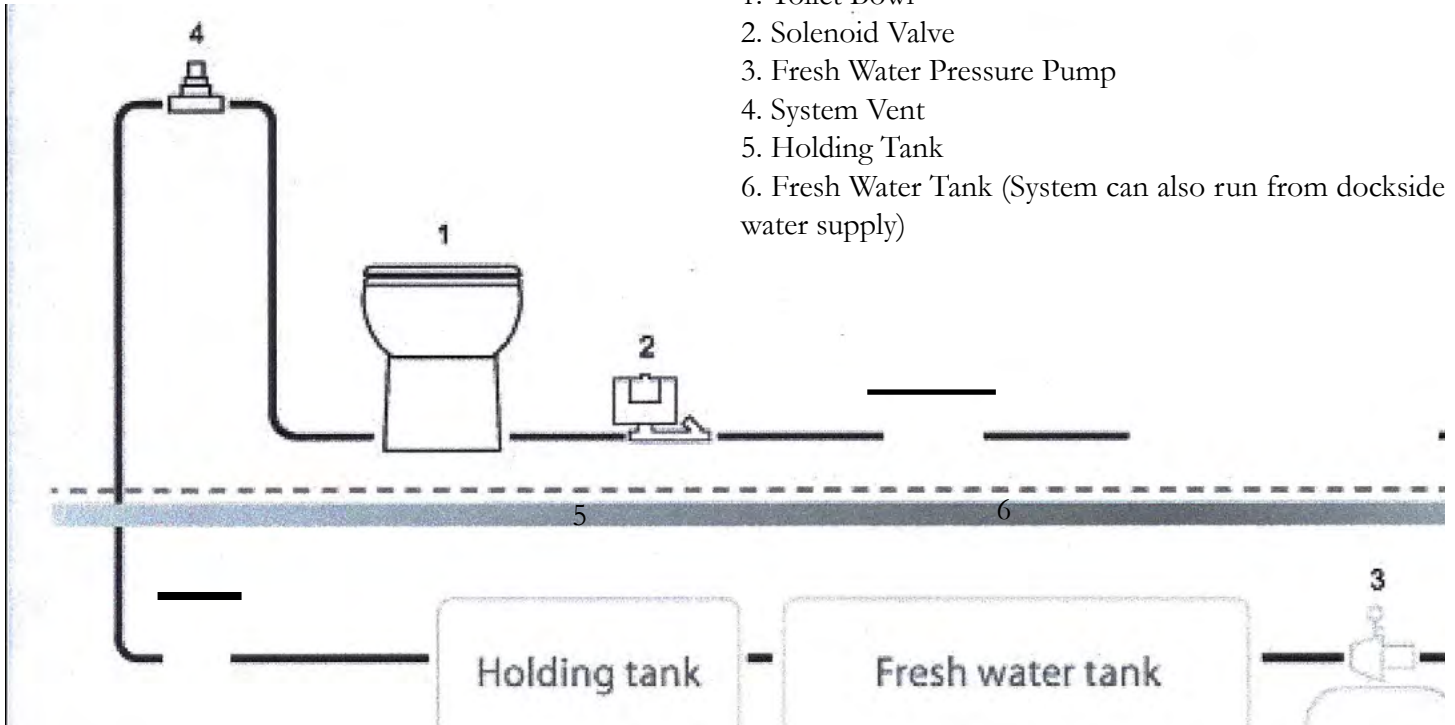



TRIM TABS

Trim tabs are installed on the lower hull at the transom area. Water is deflected and redirected as the trim tabs are raised and lowered from the dash switches. This change in water flow creates upper pressure under the tabs, and raises the stern. When the stern rises, the bow is lowered. Lowering the port tab will cause the port stern to rise, making the starboard bow lower. Lowering the starboard tab will cause the starboard stern to rise, making the port bow lower.



TRIM TAB DASH SWITCH



Obtaining A Trimmed Position

Your boat reaches a planing position at a designated speed. This speed is determined by bottom design, weight distribution, water conditions, and on board equipment. As the throttle is advanced the stern squats and the bow rises initially. The trim tabs allow your boat to plane at a slower speed than natural conditions allow.

In short bursts both trim tab rocker switches are pushed simultaneously in the “bow down” position which causes the trim tabs to move down. As the boat breaks over the bow high attitude the boat speed accelerates and visibility increases.

If the boat is over trimmed, it will plow the bow and the boat will lose maneuverability. If this occurs, simply short burst the “bow up” trim tab rocker switches simultaneously.

In the “learning curve” process, press the tab switches in half second bursts. You will notice a slight delay from the time the switches are pushed until the boat reacts depending on vessel speed. You will know after awhile the optimum planing angle and speed.

When running in heavy seas press the “bow down” position which will assist the vessel to cut through the waves. This will produce a drier and more comfortable ride.

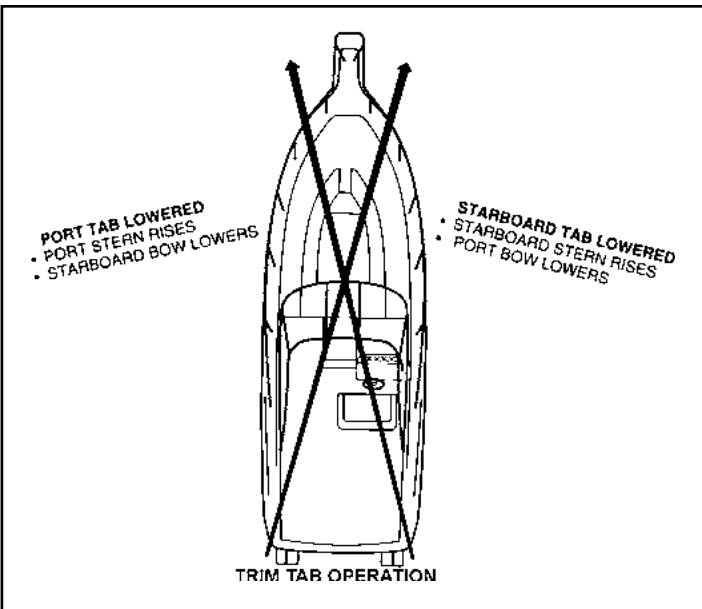

Using trim tabs will compensate for uneven weight distribution, listing, water conditions, wind velocity and other factors that cause inefficient operation.

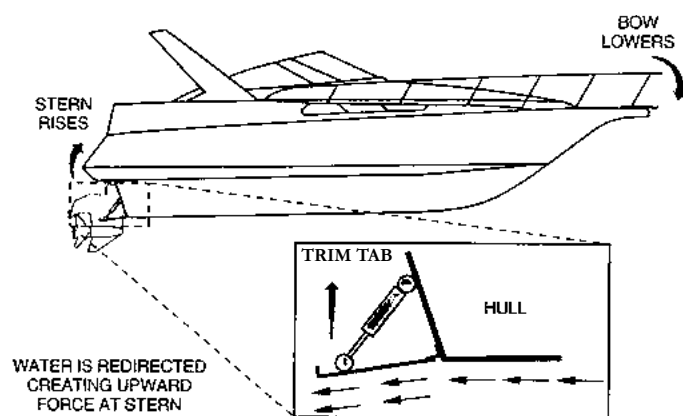

When trimmed or in the bow down position, the bow spray is farther forward, the wake is smaller, and positioned further behind the vessel. Also, when trimmed you will notice that the tachometers show an increase in rpm's.

Rectifying A List

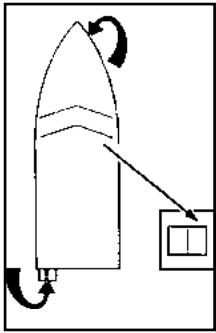

lowered.

Your vessel can use the trim tabs to rectify a list. The trim tabs adjust the boat's attitude in the direction the helm rocker switch is pushed.

If the port bow is high, push the left-hand "bow down" direction on the dash rocker and the port bow will lower. If the starboard bow is high, push the right-hand "bow down" direction and the starboard bow is

Porpoising

Porpoising is a running condition where the bow "bounces" up and down similar to a porpoise motion. Press "bow down" in one-half second bursts. As the trim tabs turn, the porpoising should recede and the vessel speed should increase. Only a small amount of "bow down" is normally necessary to make this change.

Trim Tab Pump



The trim tab pump is located in the aft bilge near the floor. It supplies a special hydraulic fluid to the transom based trim tab cylinders which move up and down with the rocker switches to operate the actual trim tab plates attached to the cylinders at the transom.

Periodically check the pump level. Fill with specified fluids as notated in the vendor trim tab

information. Never use the top as a step when entering the bilge from the swim platform. Also, check hose for leaks and ensure all connections are tight.



TYPICAL WINDLASS OPTION

INTRODUCTION

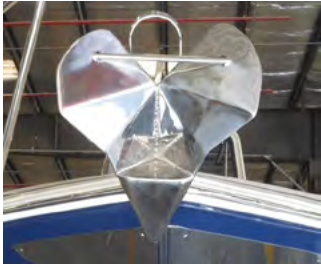

Using the anchor windlass requires knowledge of the anchoring process to understand the correct amount of rode and scope required. Read the section on anchoring, the windlass operation manual and

understand all safety information before attempting to run the windlass. Also, since anchoring is one of the skills the skipper should master for cruising “peace of mind” visit your local library or “surf” the internet to locate further information regarding anchoring techniques.

WINDLASS SAFETY TIPS & WARNINGS

- Never use the windlass to tow or pull a boat.
- Never use the windlass for securing the anchor line. Instead use a deck cleat.
- Never drop anchor in the vicinity of divers or swimmers.
- Never wrap chain around the drum.
- Never use the windlass to pull up a person.
- Never use windlass to break anchor loose.
- Always strive under normal conditions for a 7:1 scope ratio on the anchor line.
- Always remove the handle from the gipsy when operating windlass from the foot controls.
- Always turn the windlass deck switch to the “off” position when not in use.
- Always secure the anchor chain lock in “locked” position in foul weather.
- Always keep an eye on the rope/chain locker to avoid rope buiding up under the hatch.
- Always manage the retrieval process carefully to prevent the anchor from hitting the boat.



WARNING

TO PREVENT POSSIBLE BODILY INJURY
KEEP ALL BODY PARTS AND LOOSE
CLOTHING AWAY FROM
WINDLASS MOVING PARTS!



WARNING

TO PREVENT POSSIBLE BODILY INJURY
TURN OFF ALL WINDLASS POWER SOURCES
BEFORE PERFORMING ANY WORK ON
ANY WINDLASS COMPONENTS!

WINDLASS ANCHOR LINE

Although several variations exist the windlass is normally outfitted with 3/4 “ twisted nylon line and 7/16” chain. With this combination the vessel meets normal working load conditions and the rope/chain combination protects the rode. The heavier chain lowers the angle of pull and helps bury the plow anchor which increases the holding power.

When the plow anchor is buried the chain is protected from bottom chafing as the vessel is moved around due to current, waves and wind conditions.

Several methods of securing the anchor to rode are used today including eye splices, thimbles and shackles. Regal uses a set of hexagon threaded pins which are lock tightened in place. This method provides a clean finish and prevents loosening due to vibration. The bolts may be removed when necessary by using a hex fitting on a ratchet wrench.

The plow anchor featured on your vessel has demonstrated to be efficient in a variety of sea bottoms. Experts say the verdict is still out on a grassy bottom but unfortunately some grasses or weeds resist penetration by any anchor.

TYPICAL WINDLASS HARDWARE

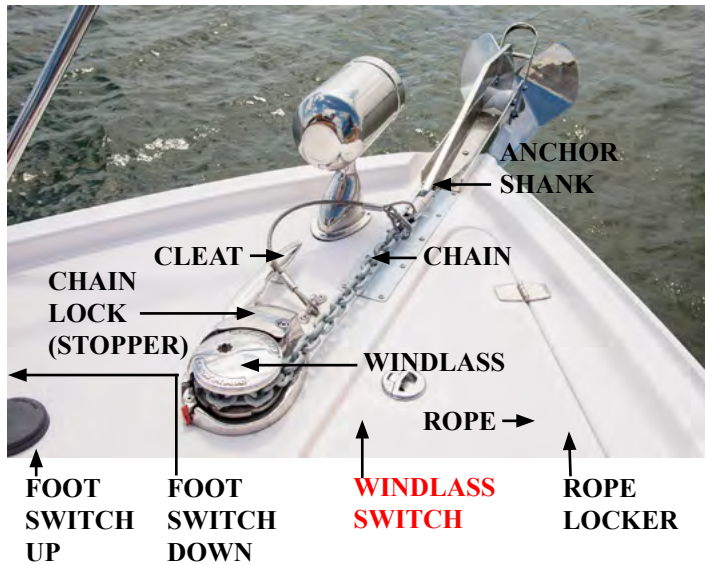

TYPICAL WINDLASS COMPONENTS

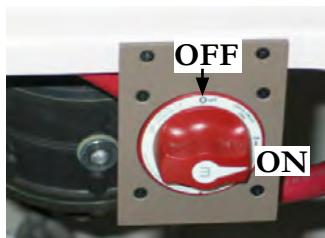

SWITCH SHOWN IN "ON" POSITION

The windlass is used to automatically raise and lower the anchor. Before attempting to lower the rope/chain rode check the rope locker for tangled rope or chain. As seen in the illustration above open the deck locker to gain access to the windlass switch. The switch "off" position is at 12 o'clock. With the switch "on" position (shown above) at 3 o'clock the foot switches are energized. If the foot switches have no power when switch is activated check the breaker located at the battery management panel.

Note that all rope/chain windlass shown above verses all chain model.

The chain lock (stopper) is used to hold the chain portion of the anchor line assembly and does not effect the nylon anchor line. Before using the windlass make sure the chain lock (stopper) is positioned with the lever pointing toward the stern.

The chain lock "dances" or ratchets over the chain while the process of retrieving the anchor rode is underway. The chain stopper will lock the chain once the anchor is completely retrieved into the bow pulpit chute.



Note: Make sure the chain lock (stopper) is positioned to engage the chain once the anchor is retrieved. This prevents the chain from paying out under abnormal conditions or when a weakened gypsy clutch condition exists.

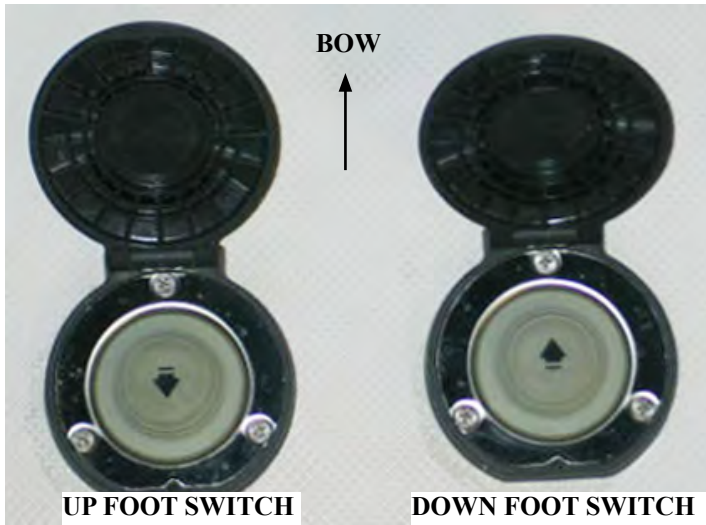

On select models bow foot switches are used to control the windlass. To use the foot switches remove the protective caps. When you energize the up foot switch the anchor is retrieved. When you energize the down foot switch the anchor is payed out. After the anchoring process is completed close the protective caps.

TYPICAL WINDLASS OPERATION

Paying Out Anchor

1. Ensure both the battery switch at the battery management panel and deck foot switch are energized.
2. Check the anchor rope locker for proper anchor line alignment. Untangle any crossed lines.
3. Check the proposed anchoring area for swimmers or divers.
4. Position vessel at proposed anchor drop site.
5. Check that pawl is in disengaged position.
6. Make sure chain stopper is in a released position.
7. Step on the **down** foot switch to pay out the chain and anchor line. When the anchor hits the sea bottom disengage the foot switch.
8. While the captain “bumps” the vessel in slow speed reverse pay out the anchor line until the correct scope is reached.
9. When scope is reached secure the anchor line around a cleat. Never use the windlass as the sole means of holding the anchor.
10. Check the anchor position by checking the position using the GPS. The GPS features an anchor alarm. Refer to the GPS owner’s manual for further information.

Retrieving Anchor

1. Check the anchor locker for any tangled lines.
2. Ensure both the battery switch at the battery management panel and deck foot switch are energized.
3. Undo the anchor line at the cleat.
4. Step on the **up** foot switch to retrieve anchor line as the captain “bumps” the vessel toward the anchor while maintaining a relatively straight anchor line position. Note: Breaker may blow if the captain does not bump the engines in gear due to the pressure on the windlass.
5. Once the vessel is over the anchor and it is broke free continue to retrieve the anchor. Check the anchor locker for tangled line and sweep the looped line out of the way if locker is filling up with line.
6. Once the anchor is approaching the bow slow down the windlass to ensure proper entrance at the chute and to avoid hitting the bow.
7. Once the anchor is completely retrieved “bump” the down foot switch to lock the chain.
8. As soon as possible after the cruise use the bow locker wash-down to rinse off the anchor, chain and line. Coil the line on deck to air dry. This will aid in preventing mildew and salt deposit build-up.

Independent Warping

Once the primary rode is secure the drum can be used for docking or an additional rope only rode. To use this feature:



TYPICAL WINDLASS

- Make sure the chain lock is secured.
 - Pawl to be in disengaged position.
 - Disengage clutch by inserting the winch handle (mounted in deck locker) in top nut and turn counter-clockwise 1/2 a turn.
 - Remove handle and store in its designated location.
- The drum will operate independently from the gipsy.
 - When finished using drum, insert winch handle in top nut and turn clockwise 1/2 turn to re-engage clutch.



Manual Free Fall

The anchor can be dropped without the use of battery power with this feature.

To use:

- Check that pawl is in disengaged position.
- Release the chain stopper.
- Insert winch handle in top nut. Loosen top nut by turning counter-clockwise until anchor drops.
- Control the rate of fall with handle.
- Once paid out fully tighten top nut.

To avoid possible bodily injury and/or property damage read and understand the windlass operation manual before attempting to use the windlass or anchor components.

TYPICAL WINDLASS SYSTEM OVERVIEW

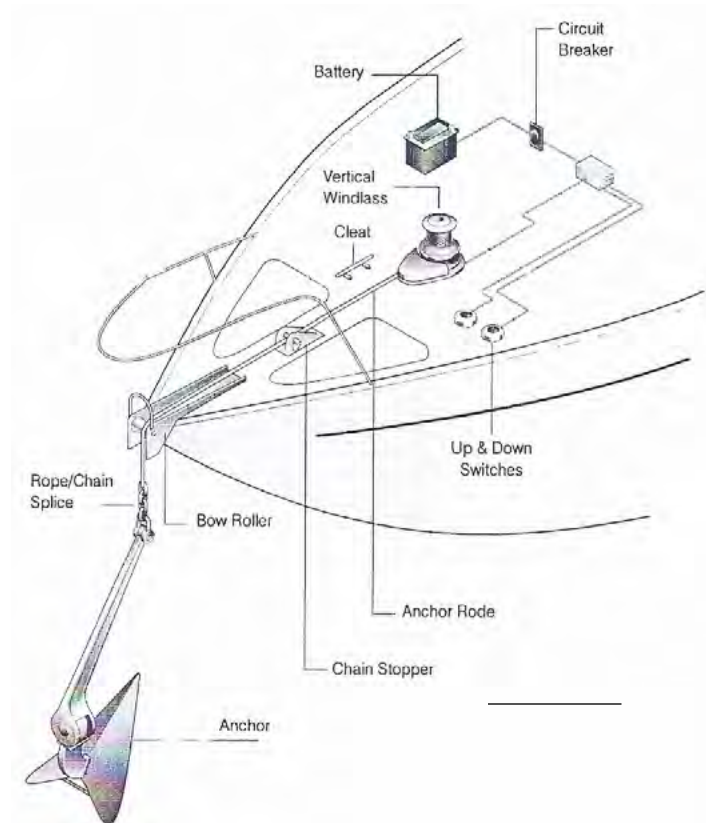

TYPICAL WINDLASS-SAFETY WARNINGS

- ◆ Ensure that limbs, fingers, hair and clothing are kept clear of the windlass and anchor during operation.
- ◆ Check to see that there are no swimmers or divers nearby before dropping the anchor.
- ◆ Remove the handle from the gipsy when operating the windlass from the foot controls or helm switch power.
- ◆ Always turn the windlass power supply to the “off” position when not in use.
- ◆ While at anchor, the load on the chain/rope must be transferred to a cleat.
- ◆ Do not use a windlass as a holding device for towing.
- ◆ Never use a windlass to lift a person, boat, etc.
- ◆ Check to make sure the permit switch is locked when the windlass is not in use.
- ◆ Remove the anchor safety lanyard before powering up the windlass.
- ◆ Fasten the anchor safety lanyard immediately after the anchor is positioned at the bow.
- ◆ Do not attempt to pull a load greater than the rated load of the windlass.
- ◆ Always use the vessel’s engines to aid anchor recovery.
- ◆ Refer the the windlass manufacturer’s owner manual for more detailed operating and maintenance information.

TYPICAL ENTERTAINMENT SYSTEM

OVERVIEW

Your vessel features a variety of standard components that provide both visual and audio entertainment. In addition, there are optional systems noted in the following pages. **Regal reserves the right to delete, add, or change both standard and optional components at anytime without notice.**

Please refer to the individual owner's manuals and the technical section (schematics) for further entertainment system information along with the internet where further technical data and updates are available.

TYPICAL TV WITH DVD PLAYER



The optional television uses DC (12 volts) current to operate unlike most home sets that use AC (alternating) current. A DVD player is built into the television which permits movie watching. To view the television activate the device power button. The television uses its own antenna with the signal strength to pull in local television broadcasting.

For more detailed operating information refer to the vendor operator's manual for each of the TV sets.

Note it is a good idea to keep extra batteries aboard for the television remote controls. The batteries seem to malfunction when you need them most.



DVD-CD

Checking For Disc Compatibility

If you encounter a problem when attempting to play a disc, check to make sure it is one of the compatible types as shown below.

- Video DVD 
- Video CD 
- DVD-R, DVD-RW
- Audio CD 
- CD-R
- SACDs (CD-compatible content only)
- MP3 CDs:
 - burned in a single closed session
 - in disc format ISO9660
 - with .mp3 as the extension and no other periods in the file name.

Disc Care

Dirt or scratches on a disc can prevent it from playing properly.

You can avoid this problem by:

1. Handling all discs by their edges to prevent fingerprints and scratches. Return them to their cases after use.
2. Avoiding exposing discs to chemical products that can cause damage
3. Writing directly on a disc or on a label attached to the disc.
4. Direct sunlight, high temperatures, and humidity.
5. Always use a soft, dry and lint-free cloth to clean the disc. Wipe straight out from the center to the edge.

WIPE STRAIGHT OUT



DO NOT USE A CIRCULAR MOTION



TYPICAL STEREO



The stereo is located at the galley. The unit features a Uni-dock and Blue-tooth compatible for different brands of cell phones.. See photo above.

An iPod features several adapters to cover an array of earlier and later vintage iPods currently in the market-place.

Stereo over current protection is located on the fuse block inside the galley. To access fuse block remove the waste basket. For further information refer to the vendor manual located in the owner's information packet or search the Goggle under FUSION as a key word.

Note: Most modern electronic devices such as smartphones and tablets have a limited operating temperature range and smartphones are optimized to operate in a narrower temperature range than MP3 devices. All electronic devices generate heat during normal day-to-day use and to reduce temperature while they are being used may stop charging, the device may display a temperature warning, and eventually may shut down if the operating temperature exceeds its specified limits.

If you are in an environment where there is a high ambient temperature and the device shuts down while inside the unit, remove it and let it cool down.



TYPICAL FUSION 650 OR 750 STEREO OVERVIEW

Both stereo units mentioned above are used in our vessels. Many of the component related operations are identical in both stereo models. *Please refer to the individual stereo owner's manuals and the technical section (schematics) for further entertainment system information along with the internet where further technical data and updates are available.*

MS-IP700

Before inserting your iPod or iPhone into the MS-IP700 you must first insert the correct sleeves to match the iPod or iPhone model. For the iPod nano (6th gen), the iPod must be placed inside the adaptor sleeve, and then placed inside Dock sleeve combination A + B

MS-AV700

Connect your iPod or iPhone via the standard Apple sync cable at the rear of the unit for connectivity. MS-DKIPUSB Portable Media Device Dock will connect to the MS-AV700 stereo and provide iPod or iPhone integration (Refer to the MS-DKIPUSB user manual for iPod/iPhone sleeve combinations and compatibility).

BEFORE INSERTING iPod or iPhone:

- Please ensure iPod dock connector is clean, dry & free from damage.
- Check that unit iPod dock is free from obstructions.
- Insert correct sleeve combination to match your iPod or iPhone
- Never insert an iPod or iPhone without the correct sleeve.
- Ensure your iPod or iPhone is inserted with display facing upwards, Never force your iPod or iPhone into the dock, if the unit does not mate with reasonable ease the sleeve/iPod combination is most likely incorrect.

SELECTING THE CORRECT iPod SLEEVE

(MS-IP700) A different set of sleeves is used for each iPod or iPhone model. The different sleeve combinations are outlined in the chart below:

iPod Model	Top Sleeve	Bottom Sleeve
iPod touch 2nd gen	D	D
iPod touch 3rd gen	D	A
iPod touch 4th gen	D	D
iPod nano 4th gen	E	D
iPod nano 5th gen	G	G
iPod nano 6th gen	A	B + Adaptor
iPod classic, 80GB	B	A
iPod classic, 160GB (2007)	B	B
iPod classic, 120GB	B	A
iPod classic, 160GB (2009)	B	A

iPhone Model		
iPhone 4	A	D
iPhone 3GS	F	F
iPhone 3G	F	F

USER INTERFACE AND CONTROLS

CONTROL PANEL LAYOUT



BUTTON DESCRIPTION



PRIMARY SOURCE	
MS-IP700i	MS-AV700i
iPod	DVD







ROTARY ENCODER AND MENU KEY

Although the controls of the 700 Series are designed to be intuitive to use, we recommend that you familiarize yourself with the operation of the Encoder and Menu key before using the unit.



ROTARY ENCODER OPERATION

The Encoder can be used in three ways to control the operation of the 700 Series:

1		Rotary Encoder turn
2		Encoder press
3		Encoder press and hold down for at least one second

MENU KEY OPERATION

You can use the Menu key to open or to exit from menus:

	Menu key	Press the Menu key to open a menu.
	Menu exit	<p>In an open menu you can use the Menu key at any time to save changes and exit:</p> <ul style="list-style-type: none">• Press the Menu to exit from the current menu level or control screen.• Press and hold down the Menu key to exit from the menu completely. Or press any other key. <p>Time out feature: After 10 seconds of inactivity, the menu exits and any changes are saved automatically.</p>

USING THE ROTARY ENCODER AND MENU KEY

You can use the Rotary Encoder and Menu key to adjust levels, access menus and open control screens.

Adjusting levels

Use the Encoder and Menu key to adjust levels on the 700 Series.

For example, to adjust the volume level:

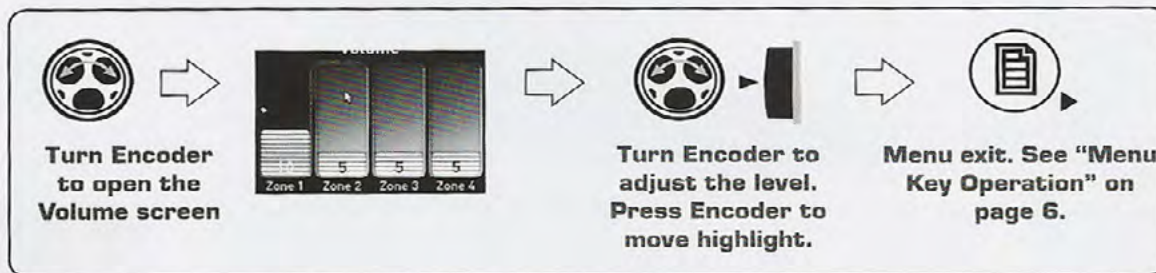

Accessing Menus

Use the Menu key and Encoder to access menus to change settings.

For example, to access the Settings menu:

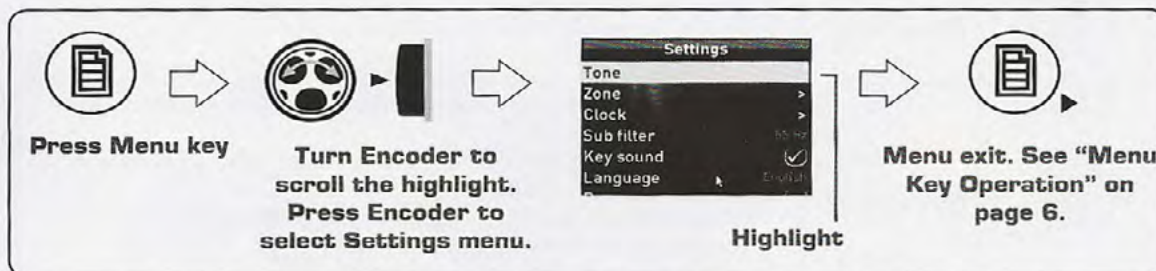



Opening Control Screens

Use the Encoder to open the Sub Level and Tone control screens to adjust levels:



GETTING STARTED

POWERING THE UNIT ON OR OFF

When you power on the 700 Series it will automatically start playing music from the most recently selected input source.

To power the unit on or off.

 Power	<ul style="list-style-type: none">• Momentarily press the Power key to power on the unit. As the unit starts up, a splash screen is displayed for several seconds, followed by the current input source.• When the unit is on, momentarily press the Power key to power off the unit.
---	--

INPUT SOURCE SCREENS

The 700 Series supports a wide range of input source types, depending on model:

- **MS-IP700i** AM/FM/VHF/SiriusXM; iPod/iPhone via internal dock; USB and iPod/iPhone via external dock or cable; auxiliary.
- **MS-AV700i** AM/FM/VHF/SiriusXM; CD/DVD; USB and iPod/iPhone via external dock or cable; auxiliary.

Both models are also SiriusXM-Ready (USA only) requires optional SiriusXM Connect Vehicle Tuner. For further details of setting up SiriusXM options see "SiriusXM Satellite Radio" on page 49.

When you select one of these sources, the 700 Series displays a source screen, similar to the AM source screen shown in Figure 1 below. The title bar always shows the current time and source name. Other information varies depending on the source type you have selected.

Figure 1 – Example source screen (AM input selected)

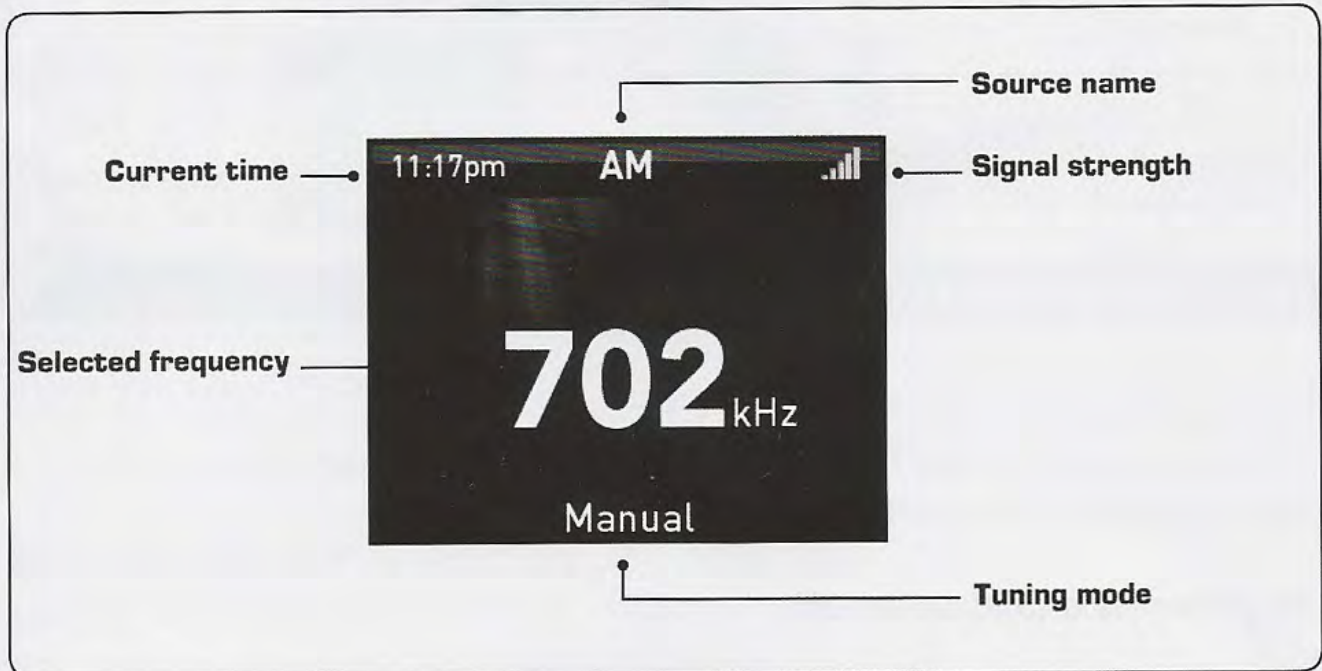

ADJUSTING VOLUME LEVEL

The 700 Series allows you to control speaker output volume level in up to four named areas called Zones. Note: Zone 3 and 4 require additional amplification.

If you wish, you can customize the settings for each Zone by defining a volume limit, a balance setting, a sub-woofer level and a personalized name (such as "Saloon" or "Galley"). For further details see "Zones" on page 40.



To adjust the volume level:

1. Turn the Encoder.
 - The Volume screen is displayed with the Current Zone Selection Highlighted (remembered from previous use).
 - The volume is adjusted in the highlighted Zone (or Zones) only.

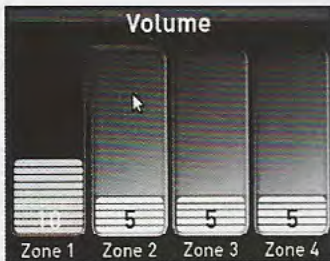

2. If required, press the Encoder to highlight the next Zone to adjust its volume level.

While the Volume screen is displayed, each press of the Encoder will highlight available Zones in the following order:

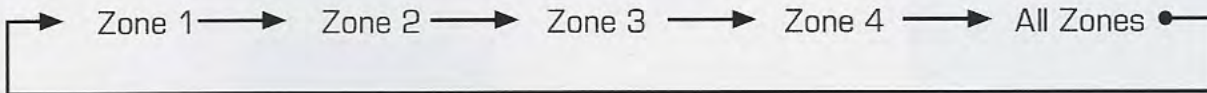

3. When finished, press the Menu key (or leave to time out) to save the current volume level and exit.

MUTING OUTPUT

To mute and unmute the volume:



Mute



- Press the Mute key to mute the audio output. The Mute icon is displayed over the top of the current input source screen.
- Press the Mute key again to unmute the audio output. The volume continues at the previously set level.

iPod

PLAYING CONTENT

Before you can use your iPod as an input source you must first connect the device to the 700 Series. For further details, see "Preparing for iPod or USB Input" on page 43.

To listen to input from your iPod:

MS-IP700i	 iPod	<ul style="list-style-type: none"> • Press the iPod key. The iPod input source screen is displayed. The most recently selected track starts playing at the current play point. • To appear on the iPod source screen the iPod may either be inserted into the internal dock or connected to the external USB connector.
MS-AV700i	 Auxiliary	<ul style="list-style-type: none"> • Press the Auxiliary key. Keep pressing the key until the iPod source screen is displayed.

iPod SOURCE SCREEN

An example of a typical iPod input source screen is shown in Figure 4 below.

Figure 4 – Example iPod input source screen





CONTROLLING iPod PLAYBACK





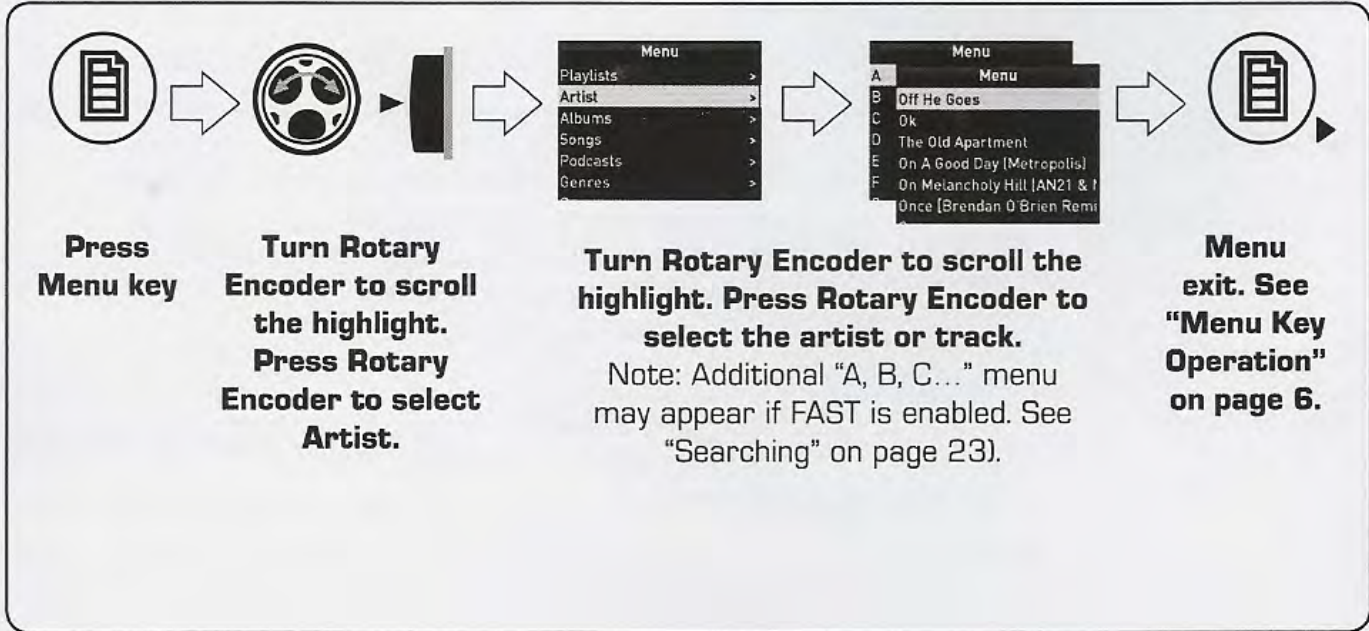



Selecting tracks from a playlist

There can be thousands of tracks stored on an iPod, so you need to select the tracks you wish to play from one of the groupings available (such as Playlists, Artists, Albums). For example, to select tracks by artist:



Controlling Playback

You can control iPod playback with the Play / Pause, Forward and Rewind keys. The selected track starts playing automatically.

If you want to:	Use:	Notes:
Play / Pause a track	 Play / Pause	<ul style="list-style-type: none"> Press the key to pause the current track. The pause icon () is displayed top right in the input source screen. Press the key again to resume play. The play () icon is displayed in the input source screen.
Skip to next track	 Forward	<ul style="list-style-type: none"> Press the key to skip to the start of the next track.
	 Rewind	<ul style="list-style-type: none"> Press the key to skip to the start of the current track. Press the key twice to skip to the start of the previous track.
Fast forward / rewind	  Forward, or Rewind	<ul style="list-style-type: none"> Press and hold down the key to fast forward (or Rewind) the playback. The fast forward () (or Rewind) icon is displayed in the input source screen.



Subtitles

- **Off.** Subtitles are not displayed when the iPod is playing video
- **Subtitles.** Subtitles are displayed
- **Closed caption.** Provides additional information about the track (if available)

Album artwork

- Display album artwork if available
- Do not display album artwork

MS-IP700i MODEL

Note: If you select iPod or USB input without first connecting the device, the message “Not connected” is displayed on the screen.

Important Note: Connecting Supported iPods and iPhones to a MS-IP700i Stereo

The MS-IP700i provides two connection options for iPod and iPhone users. Supported devices may be either inserted into the internal dock or connected to the external USB connector.

The MS-IP700i Stereo does NOT support multiple iPod or iPhone devices connected simultaneously. Correct operation is only guaranteed with a single iPod/iPhone device connected.

Note; For connection to the external USB connector a Apple sync cable or external FUSION MS-DKIPUSB dock is required.

Before connecting iPod

To avoid damage and ensure safe operation, please read the following information before using your iPod.

- Please ensure iPod dock connector is clean, dry and free from damage.
- Check that the unit's iPod dock is free from obstructions.
- Insert correct sleeve combination to match your iPod (never insert iPod without the correct sleeve).
- Ensure iPod is inserted with display facing upwards.
- Never force your iPod into the dock, if the iPod does not mate with reasonable ease, the sleeve/iPod combination is most likely incorrect.
- Take care when removing iPod from unit as surfaces may be warm.

To insert your iPod:

1. Press the door catch and open the control panel door.

Press the door catch



Open

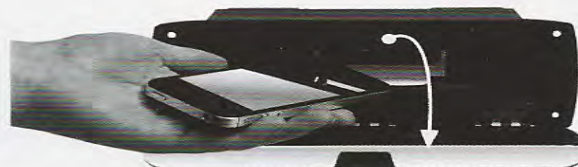

2. Insert your iPod in its sleeve (see iPod compatibility sheet supplied separately). Make sure that the device is firmly pushed onto the connector socket.
3. Close the control panel door firmly.
4. Select input from the device, as required.

MS-AV700i and MS-IP700i Models

The 700 Series stereos provide an external USB connector (rear cable assembly) for connection to external iPods, iPhones, USB storage devices or FUSION MS-DKIPUSB dock.

To connect your iPod, you will need:

- Portable media device dock (MS-DKIPUSB), or
- Apple Sync Cable.

To connect your USB flash drive, you will need:

- Portable media device dock (MS-DKIPUSB), or
- Connect your USB flash drive directly to the external USB cable.

Note: If you select iPod or USB input without first connecting the device, the message “Not connected” is displayed on the screen.

Note: For further information read the stereo operator's manual in the owner's information packet.



Typical Chart plotter

The unit features a touchscreen, NMEA 2000 compatible, multifunction display, pre-loaded with U. S. coastal maps and interfaces with other electronic components. It displays graphics with crisp, video-quality resolution.

Chart plotter Operation



Before operating the chart plotter read and understand the vendor supplied owner's manual including all the warning information.

These chart plotters feature "touch" screens.

When you see information groups on the screen use your finger to touch the format desired. With some information in particular it is required that you actually drag an object by using your finger and keeping it on the screen as you move the object.

A. To power the system the "house" battery needs to be activated by the battery switch at the battery management panel.

B. Next, turn the helm electronics switch to the "on" position. This powers up the GPS antenna and the auto pilot. The chartplotter is now ready to power up.

C. Press and release the chartplotter power key. When the warning screen appears, touch I agree. At this point you will be taken to the home page screen.



Home Screen

Charts- Selects navigational charts and radar overlay functions.

Radar- Sets up and provides sonar information through the optional transducer.

Information- Shows tide conditions, currents, celestial data, information about other vessels, your yacht's instrumentation, and video.

Mark- Marks, edits, or deletes your current location as a waypoint or Man Overboard

Where To?- Searches and navigates to service areas, routes and waypoints.

Combinations- formats screen to view a chart, sonar, radar, and video cameras (2 cameras on each chartplotter; requires the extra chartplotter option).

Configure- Permits the editing of chartplotter system settings (Can set a simulator mode where you can practice using most of the chartplotter functions).

Man Overboard- Marks your current position as a waypoint, and sets a course back to the marked location.

Once you are able to navigate to the home screen each of the electronic onboard components can be formatted and adjusted to meet individual needs and the finer points of cruising requirements. Continue to read the electronic owner's manuals for adjusting the finer settings on the chartplotter(s).

Typical VHF Marine Radio

The optional VHF marine radio features up to 25 watts of transmitting power and DSC capability. There are dedicated soft keys linked to a screen to select and view the information the operator needs.

The radio is interfaced to the chartplotter which permits you to obtain mayday signaling and a digital broadcast of your boat's position. The unit offers premium sound quality so each message is loud and clear. Also, the VHF receives NOAA weather alert information.

Read and understand the vendor supplied information on the operation of the unit. Be sure to train a crew member on how to use the VHF marine radio should the captain become unable to carry out his duties.



Engines & Controls

Note that selected outboard engine and control information will be found in the outboard section at the end of this chapter. Refer to the manufacturer's outboard engine operators manual for more detailed information.

Keep in mind that many Regal systems and components are similar between the stern drive and outboard models so becoming familiar with this entire manual is recommended.

STERN DRIVE OVERVIEW

This section introduces the stern drive propulsion system-engine and drive. This is not to be thought of as a complete workshop manual. This manual will highlight a portion of the engine and drive information

Read the Volvo or MercCruiser engine manual carefully and understand the operation as well as the necessary maintenance requirements of the engines and related drive system components before operating the vessel. Contact your closest Regal dealer or repair facility for maintenance or parts needs.

Always begin maneuvering in a controlled environment where you can practice shifting and docking operations at your own pace. Learn how the vessel's engines and propulsion systems behave at different speeds, in varied sea conditions, and under light and heavy loads. Always keep the safety of others in mind as you practice docking. Learn to monitor the helm gauges, electronic equipment, and warning systems as they are your on board friends. Read all safety labels and practices. Review with a crew member all the component operations in case the captain would become unable to carry out his duties as skipper.

Note: Your Regal dealer has been factory trained on the various vessel systems. Consult your Regal dealer for further information regarding technical support and parts.



WARNING

AVOID SERIOUS INJURY OR DEATH!
READ ALL MANUFACTURER'S ENGINE
AND PROPULSION MANUALS
BEFORE STARTING OR OPERATING
THE VESSEL.



CAUTION

NEVER RUN ENGINES WITHOUT WATER.
DAMAGE TO THE WATER PUMP, IMPELLER,
AND OTHER ENGINE PARTS
WILL OCCUR.

Engine & Controls

ENGINE BREAK-IN: ALL MODELS

All propulsion systems require a pre-determined “break in” period. During this time the engine should not be run at a full load condition for extended periods. Various engine load and speed conditions assist the internal engine parts such as bearings, valves and piston rings to “seat” properly which will help ensure a longer engine life. See operator’s manual for further information.

During the “break in” period it is necessary to check the engine oil more frequently since it is normal that the engine will use more oil. If engine oil is required be sure to check the engine manual for proper grade and viscosity.

Check the maintenance schedule in your engine owner’s manual and contact your Regal dealer to set up the first maintenance inspection. Normally the engine oil, filters, and drive oil inspections and maintenance are performed during this inspection along with other items.

Never exceed a 12 month period between oil changes especially with diesel power since sulfur tends to enter the lubrication system through the fuel combustion process over a period of time.

OIL CHANGES (ENGINE & DRIVE)

Be sure to read the owner’s manual regarding engine oil change recommendations along with stern drive oil. Be sure to follow the engine manufacturer’s recommended oil type and viscosity. The engine oil change is an important factor in obtaining engine longevity since impurities enter the crankcase through the combustion process and build up in the engine oil.

Be sure to check the drive oil on a periodic basis and change it using the recommended type per the engine owner’s manual.



VENTILATION SYSTEM

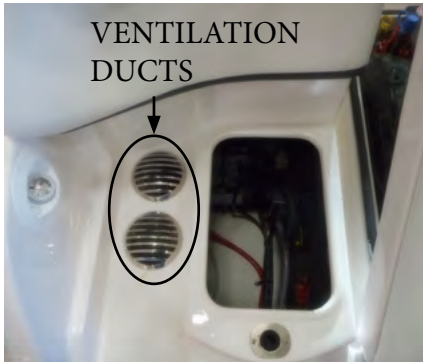

Select amounts of air are required to perform the combustion process. The higher the revolutions per minute of the engine the more air is required to meet the demand.

A natural and powered ventilation system are incorporated with gasoline stern drive engines. **Read and understand the blower warning label instructions found on this page.** As part of periodic maintenance, ensure the cowlings are free of debris including animal nests such as wasps and birds. Check and replace the engine air filters as required. See your nearest Regal dealer or marine professional for replacement filters.

Also, it is recommended that after a cruise you let the engine idle under a 'no load' condition for several minutes. Perform a visual check for exhaust and fluid leaks in the bilge. Since there is a light gelcoat color in the bilge bottom it will be easier to spot any fluid leaks.



WARNING

TO PREVENT FIRE OR EXPLOSION
DO NOT STORE
FLAMMABLE LIQUIDS IN CONTAINERS
ANYWHERE ON THE VESSEL!



WARNING

BEFORE STARTING ENGINE
CHECK ENGINE COMPARTMENT
FOR FUEL LEAKS.



WARNING

AVOID SERIOUS INJURY OR DEATH!
GAS VAPORS CAN EXPLODE!
BEFORE STARTING ENGINE
OPERATE BLOWER 4 MINUTES
AND CHECK ENGINE COMPARTMENT FOR
GASOLINE LEAKS OR VAPORS.
RUN BLOWER BELOW
CRUISING SPEED.

Engine & Controls

STERN DRIVE INSTRUMENTS AND CONTROLS

Note that the stern drive dash or sometimes called the helm features a variety of instruments (gauges) and controls depending on the engine brand and vessel options selected. We will describe several of these focusing on select gauges and controls along with basic components that overlap on all of the dashes or helms.

Read and understand your particular propulsion package instrumentation and controls found in the engine owner's manual along with this manual before attempting to operate the vessel.

Note that standard and optional equipment may change at anytime along with the appearance of select components.



STANDARD HELM LAYOUT WITH ANALOG GAUGES

TRIM
GAUGE

DEPTH
GAUGE

MULTI
GAUGE

SPEEDO
GAUGE

TACHOMETER
GAUGE

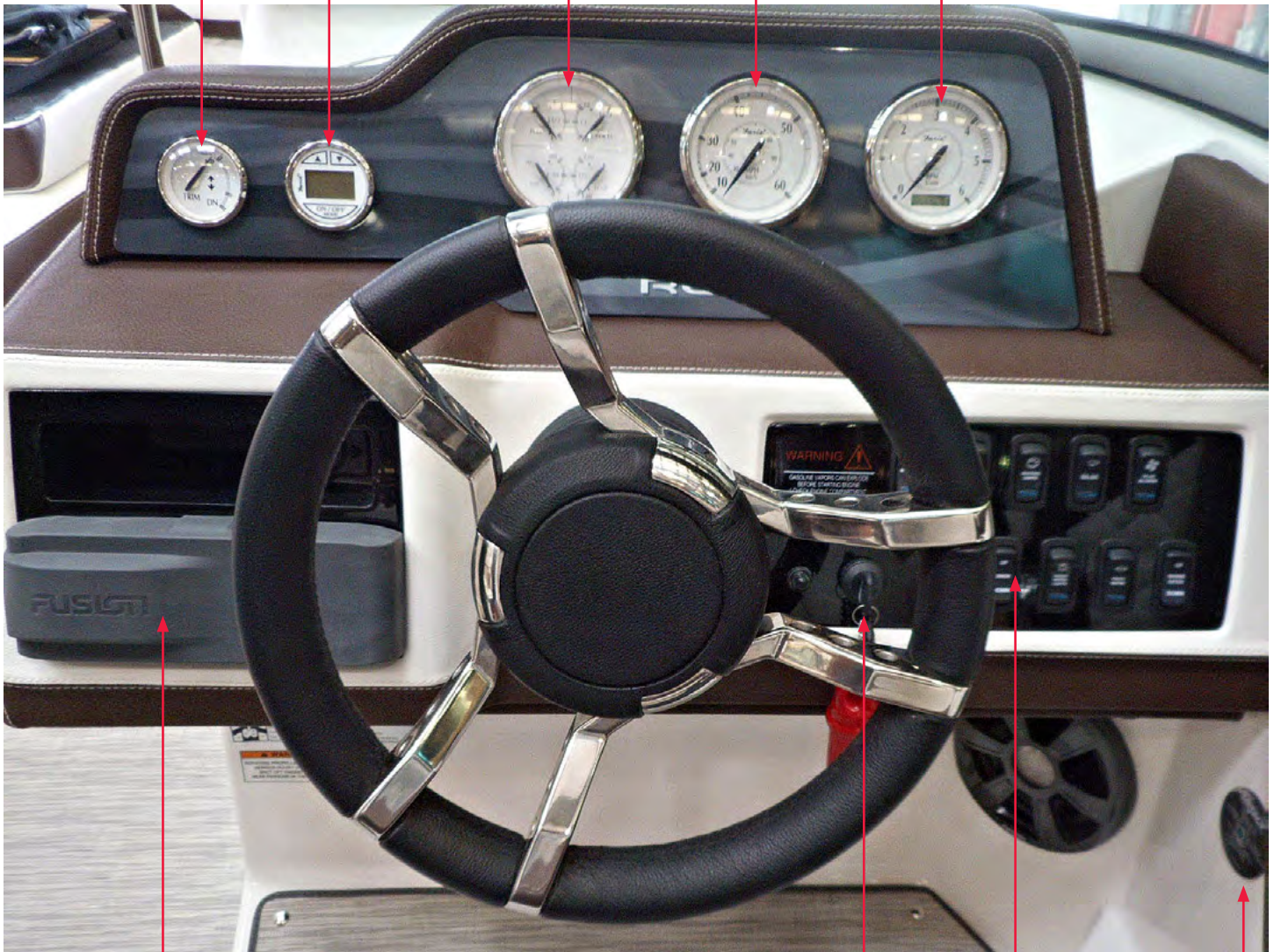

STEREO

IGNITION
SWITCH

SWITCH
PANEL

FIREBOY
GAUGE

*See following pages for gauge functions.

Engine & Controls

TYPICAL HELM LAYOUT WITH REGAL VUE

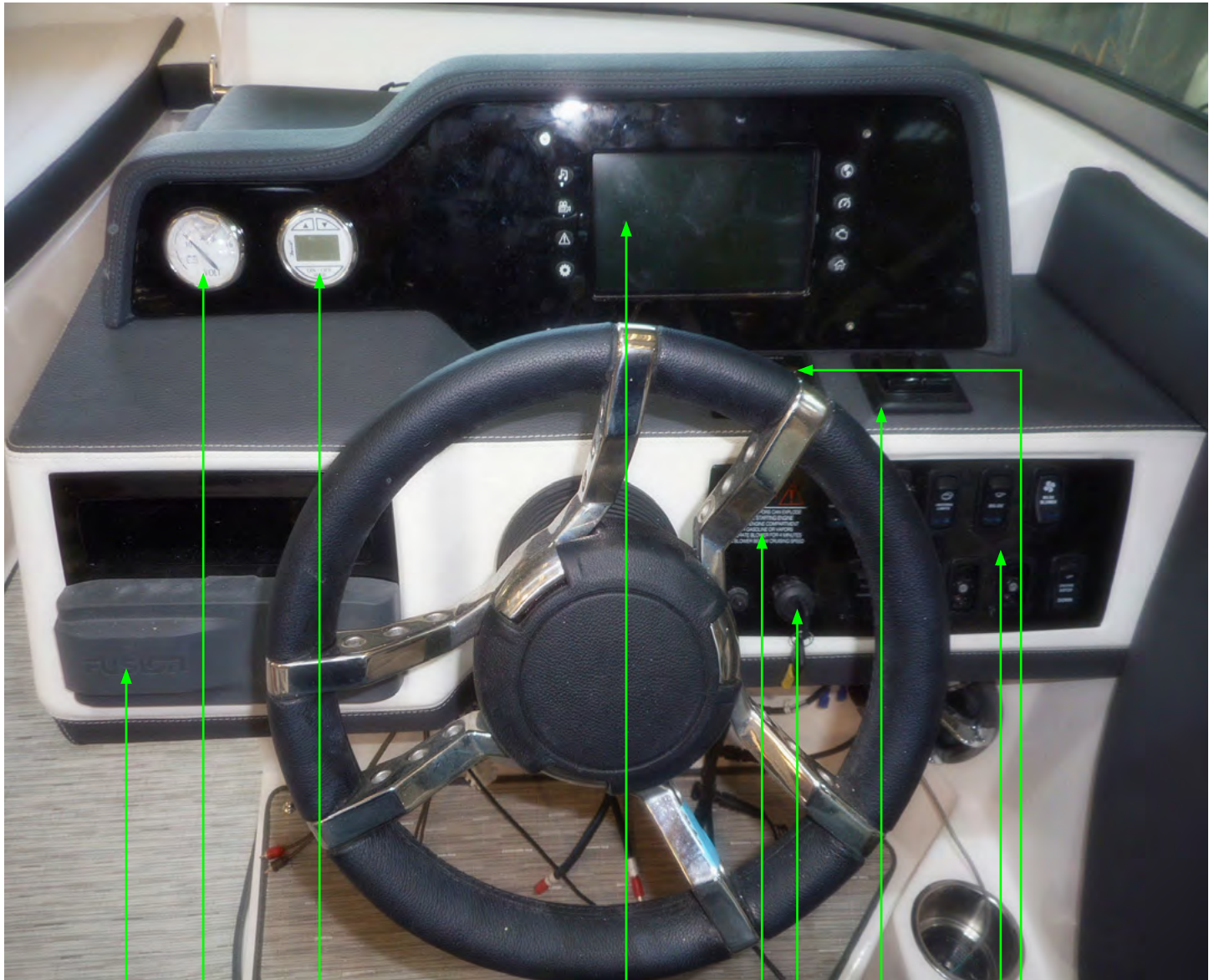

STEREO

DEPTH GAUGE

REGALVUE

SWITCH
PANEL

FUEL GAUGE

IGNITION
SWITCH

TRIM TABS

ENGINE
INFORMATION
PANEL



TYPICAL HELM LAYOUT WITH GARMIN CHARTPLOTTER

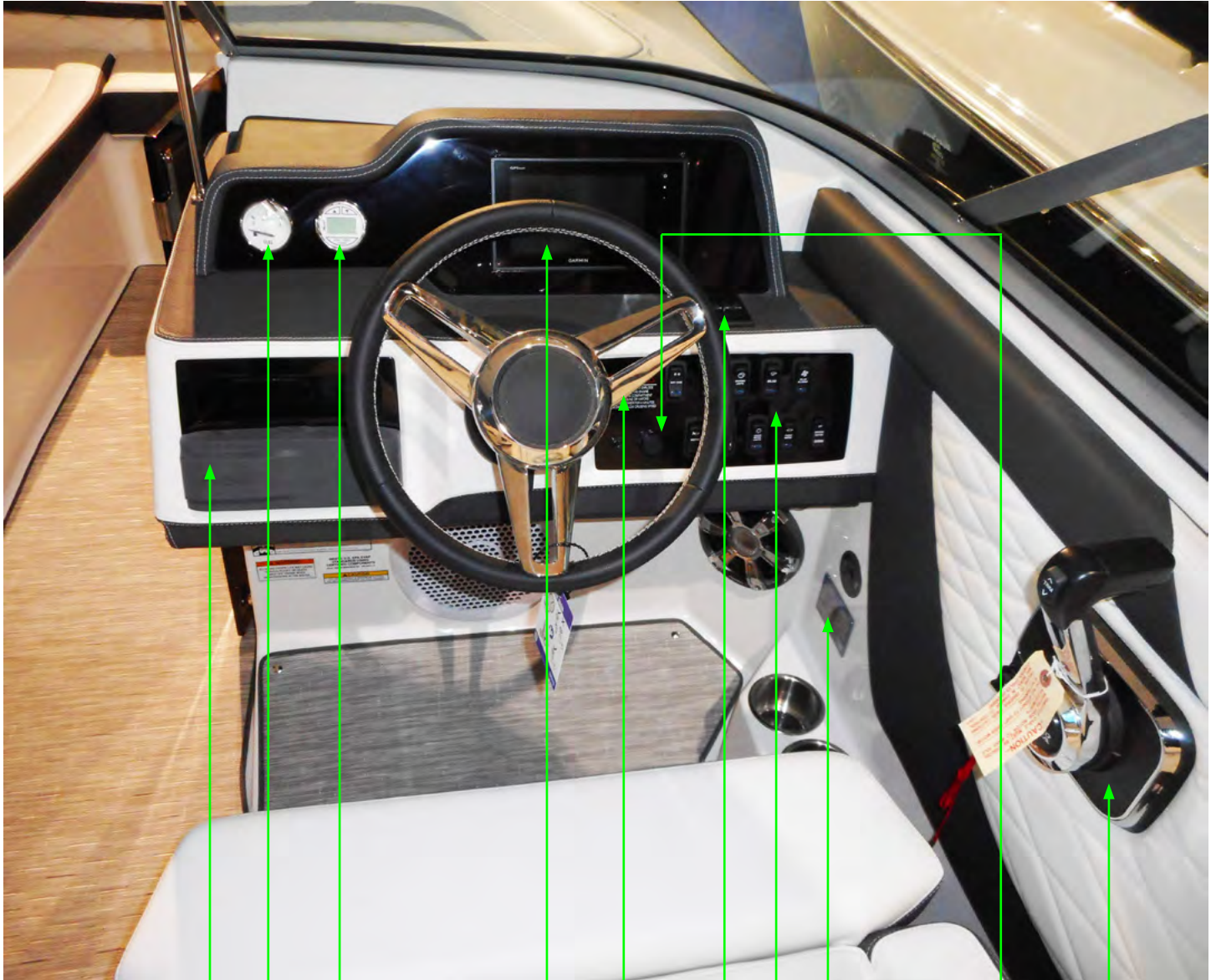

STEREO

DEPTH GAUGE

TRIM TABS

ABYC PLATE

REMOTE CONTROL

FUEL GAUGE

CHARTPLOTTER

BLOWER
WARNING
LABEL

SWITCH PANEL

IGNITION
SWITCH

Engine & Controls

ENGINES WITH KEY SWITCH PANEL

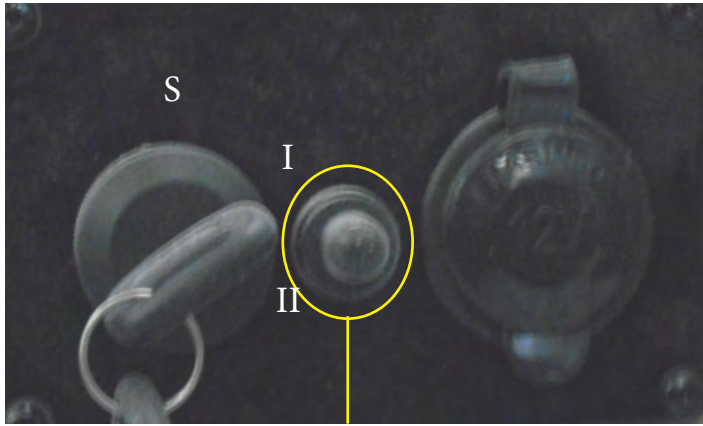

20 AMP BREAKER

Ignition key switches normally feature the following positions to identify key operating functions.

S= Stop

I= Operating Position (Ignition On)

II=Start Position (Spring Loaded)

Note that the key switch above is shown with the key in the “ignition on” position.

Read and understand the blower information on this page before attempting to start the engine. A blower switch is used on all gasoline engines.

Before turning on the blower switch do a sniff test by opening the engine hatch. At the same time check fuel tank components. When assured the bilge is clear of any fumes turn on the blower switch for at least 4 minutes before attempting to start the engine. This will vacate any gasoline fumes that are in the engine room (bilge or sump). Continue to run the powered blower system below cruising speeds after starting the engine.

A 20 amp ignition system breaker protects the ignition circuit (See above). Should a breaker “pop” find the cause of the malfunction before attempting to restart the engine.

STARTING ENGINE-IGNITION SWITCH

To start the engine turn the ignition key clockwise to the right “OPERATING” position and then to the spring loaded “START” position. Hold the key in this position as the engine will crank until it starts. Once the engine starts release the key and it will seek the operating position. To stop the engine, turn the key counterclockwise to the “off” position and remove the key from the ignition.



WARNING

AVOID SERIOUS INJURY OR DEATH!
GAS VAPORS CAN EXPLODE!
BEFORE STARTING ENGINE
OPERATE BLOWER 4 MINUTES
AND CHECK ENGINE COMPARTMENT FOR
GASOLINE LEAKS OR VAPORS.
RUN BLOWER BELOW
CRUISING SPEED.

NOTICE

TO PREVENT ELECTRICAL SYSTEM
DAMAGE, NEVER TURN “OFF”
THE BATTERY SWITCH
BEFORE IGNITION KEY IS REMOVED.

NOTICE

TO PREVENT A POSSIBLE DEAD
BATTERY, NEVER LEAVE THE
IGNITION SWITCH KEY IN THE “ON”
POSITION WITHOUT THE ENGINE RUNNING.



INSTRUMENTATION (TYPICAL ANALOG)

The helm (dash) features select gauges specifically designed to monitor the condition of the propulsion components and other onboard equipment. Close observation of the gauges is the responsibility of the captain while cruising. Periodically scan the gauges for the appropriate meter level deflections. Other instruments called displays present digital information verses needle deflection.

Become familiar with all the gauge functions and their normal operating specifications as outlined in this manual and your engine operation manual. Gauge deflection (movement) on boats is very similar to automobiles.

After educating yourself in the functionality of the instruments be sure to train another person as the skipper's backup. This person should know how to read the gauges and how to respond to system "fault" codes should they occur.

Note that the gauges shown in the following pages are typical and may vary in appearance and type depending on helm configuration along with engine and components selected.

AUTOMATIC CHARGING RELAY/ SI-ACR

Note on stern drive dual battery systems there is an automatic charging relay installed on the battery management panel.

The purpose of this device is to protect electronics by temporarily isolating house loads from the engine circuit during the engine cranking cycle.

Also, it automatically combines batteries during charging, isolates batteries when discharging and when in the engine cranking cycle.

This device supports stern drive alternators up to 120 amps. **Remember when charging up a low or dead battery with the ACR and the dual battery switch, you must select the COMBINE BATTERIES section of the dual battery switch for the low battery to recharge.**

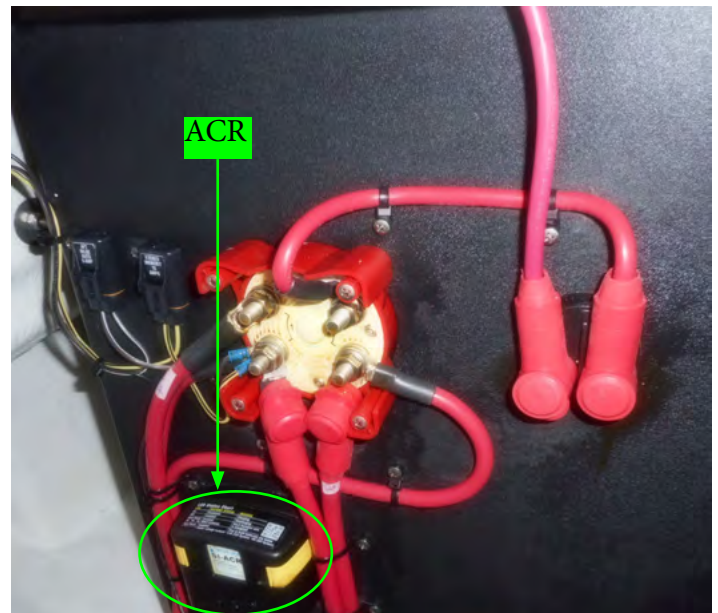

Engine & Controls

GAUGE OPERATION (TYPICAL)



Multi Gauge

The multi gauge may read fuel, oil, temperature and volt functions. The fuel section indicates the level of fuel inside the fuel tank. It is a good idea to keep the fuel tank “topped off” when

possible to reduce condensation inside the tank. Do not run the fuel level close to empty. Figure in an adequate “safety” factor (1/3 rule) when monitoring fuel gauges since they are not entirely accurate.

The oil pressure display indicates the pressure of the oil inside the engine lubrication system. A drop in oil pressure may be an indication of a low oil situation or a leak. Operation of the engines with low oil pressure could lead to engine damage. Should a low oil pressure situation develop shut down the engine immediately and investigate the problem.

The temperature display monitors the cooling system of the engine. A sudden increase in the temperature could be a sign that the engine cooling system is malfunctioning. Shut down the engine immediately and investigate the problem. Consult your engine manual for allowable limits. Engine water temperature is indicated in degrees of Fahrenheit. Engines today run warmer closer to the 180 degrees to 200 degrees.

The voltage display indicates the battery condition as well as the alternator performance. Normal voltage is between 12.0 and 15.0 volts. Readings outside of this range may indicate a charging system or battery problem.

Volts should be normally over battery voltage indicating the battery is being supplied properly by the engine alternator.

Typical engine alternator output for Volvo stern drive models is 75 amps and for MerCruiser is 70 amps.

Note the following: stator output for outboards with mechanical controls is 50 amps and outboards with digital controls is 70 amps.



Speedometer Gauge

The speedometer indicates the speed of the vessel over water. It is indicated in miles per hour or knots.



Trim Gauge

The trim gauge indicates the relative angle of the engine out drive in units. Degrees of trim are indicated as the drive unit is trimmed up. Likewise degrees of trim are shown as the drive is lowered.



Tachometer

The digital tachometer (tach) indicates the speed of the engine in revolutions per minute (rpm). Marine engines feature rev limiters to keep the engine rpm's within safe limits. Select tachometers display the engine running hours.

Note that engine hours is the gauge for marine maintenance schedules. Pay close attention to the hours of running displayed on the tachometer and the recommended system maintenance as found in your engine operator's manual.



Automatic Fire Extinguishing System



If installed the system utilizes an instrument display unit light that provides the operator with a system status of a charged or uncharged condition by an audible alarm. With the ignition switch on and a no light condition indicates that

the system has been discharged.

If the system should discharge the ignition system will be instantaneously interrupted. Should this occur shut down the engine and any electrical system components along with closing any open hatches.

If a fire has started in the engine compartment find the system manual cable assembly

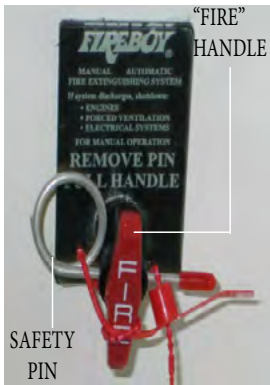

located in the cockpit. Remove the safety pin from the “Fire T Handle” and pull firmly on the “Fire” handle which will activate the fire extinguisher unit in the engine compartment. A loud “rushing air” sound may be heard. Complete discharge will take several seconds. Keep the compartment closed for a period

of time sufficient to permit the agent to soak all areas of the protected space. This allows hot metals and fuel time to cool. Refer to the automatic fire extinguisher owner’s manual for additional information.

Gas Vapor Detector



If installed the optional gas vapor detector determines if there is a level of gasoline vapors that is unsafe in the engine room of the boat. If installed, turn on the unit and wait about one minute for

it to do its safety test. If all is well it will give you a green light. You must run the test before you start the engines. In the event you don’t get a green light, you must investigate the bilge of the boat for gas fumes or signs of a fuel leak before starting the engines. If uncertain, consult a marine service professional.

NOTICE

BECOME FAMILIAR WITH THE ENGINE FAULT CODE SYSTEM. SHOULD AN ENGINE MALFUNCTION DEVELOP THE OPERATOR WILL BE ABLE TO REACT FASTER TO THE SITUATION.

Engine & Controls



Depth Gauge

The depth gauge displays bottom signals as read through a transducer installed through the hull bottom. Information can be shown as meters or feet. Read the depth gauge literature found in the following pages and owner's packet for in-

depth settings and operational tips.

In theory the depth gauge picks up a bottom signal sent through a transducer to the helm gauge unit which is converted to readings in feet, meters, or fathoms, and displayed on the gauge. The unit features shallow or deep water alarms, both of the audio and visual type, and keel offset.

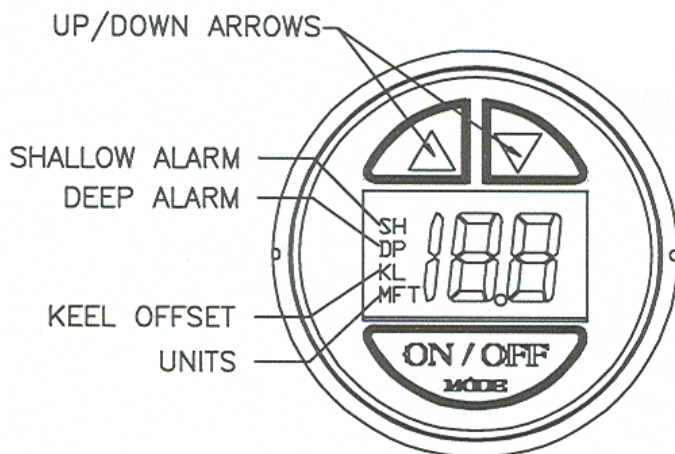

Depth Gauge With Functions

OPERATION

The depth finder will display depths of 2-199 feet, 1-92 meters, or 1-54 fathoms. To accommodate greater depths to be displayed in the feet mode (ft), the depth sounder will automatically change to the fathoms (f) mode and continue to display depths to around 54 fathoms. When the depth becomes larger than 200 feet, the display will return to the feet mode. Limits on depth will vary depending on transducers and bottom conditions.

If the reading is less than 19.9 feet, meters, or fathoms, 1/10th increments will be displayed. If the reading is more than 19.9 feet, all readings will be in whole numbers.

The depth finder features an audible and LCD displayed depth alarm with adjustable shallow and deep limits and a depth below keel offset feature. These settings once made are stored in memory and will remain, even if the battery is not connected.

POWER ON

When the helm is powered up by the key switch, 12 volt DC energy is available at the depth gauge along with the remainder of the instrument cluster. You do not need to press the "ON/OFF MODE" keypad.

The LCD will illuminate showing the depth and the type of units selected; feet (FT), meters (M), or fathoms (F). To deactivate the depth sounder, hold the "ON/OFF MODE" keypad for 4 seconds. Pressing the "ON/OFF MODE" keypad again, reactivates the unit.

DEPTH ALARM SHALLOW MODE

If you press the "ON/OFF MODE" keypad again, the shallow depth alarm setting is displayed. This is the shallowest water that will energize the alarm. Press and hold the up or down arrow keypads to adjust the reading to the desired depth.



DEPTH ALARM DEEP MODE

By pressing the “ON/OFF MODE” keypad again, the deep depth alarm setting is displayed. This is the deepest water that will energize the alarm. Press and hold the up or down arrow keypads to adjust the reading to the desired depth.

When the shallow depth setting is read by the depth finder, the “SH” will flash on the LCD and the audible alarm will sound in a rapid sequence. When the deep depth setting is read by the transducer, the “DP” will flash on the LCD and the audible alarm will sound at two beeps per second.

To fully deactivate the alarm, reset it to zero. Pressing the “ON/OFF MODE” keypad temporarily deactivates the alarm. To reactivate, press the “ON/OFF MODE” keypad until the depth reading appears.

KEEL OFFSET

By pressing the “ON/OFF MODE” keypad again, the alarm will display the keel offset setting “KL”. It can be set so the depth finder shows the depth below the transducer, or the depth under the keel. Press the up or down arrow keypads to adjust the reading to the desired depth no further than 19.9 feet.

An example would be if the keel bottom is 3 feet below the transducer, and you desire the depth sounder to read the depth below the keel, the keel offset display should be adjusted to 3.0 FT.

Once the keel offset is programmed, the shallow and deep water alarms will be energized by the depth under the keel.

UNITS

Pressing the “ON/OFF MODE” keypad again displays the units mode “UN”. Press either the up or down arrow keypads to set the units to feet (FT), meters (M), or fathoms (F). Once these units are set, they will remain the same for all modes. By pressing the “ON/OFF MODE” keypad again, the depth finder will return to the normal operations screen.

Engine & Controls

TRANSDUCER



If you should decide to use a barrier coating on the boat bottom do not paint the transducer as its effectiveness will be compromised. Never cut the main lead to shorten or lengthen it as it is been matched by the electronics manufacturer to the chartplotter.

NOTICE

AVOID EQUIPMENT DAMAGE!
THE TRANSDUCER IS A SEALED UNIT.
DO NOT ATTEMPT TO OPEN IT,
SINCE IT IS NOT SERVICEABLE.



WARNING

AVOID INJURY OR DEATH!
THE DEPTH SOUNDER IS NOT TO BE USED
FOR NAVIGATION OR AS A DEVICE
TO AVOID GROUNDING.
USE CAUTION
WHEN OPERATING IN SHALLOW AREAS
AND MAINTAIN A VERY SLOW SPEED.
BE AWARE THAT WATER DEPTHS MAY
CHANGE TOO QUICKLY FOR YOU
TO REACT AND AVOID GROUNDING!



BEFORE STARTING ENGINE

It is important that you read the engine operator's manual carefully and become completely familiar with the operation as well as required maintenance procedures on the engine and related propulsion systems.

Before starting the engine check the guidelines below:

1. Open the engine hatch and sniff for fuel smells and visually check for fuel leaks. If gasoline vapors are sensed or leaks seen be sure to determine the cause and repair the source before starting the engines. If you can not locate a fuel leak contact a marine professional immediately or your closest Regal dealer.
2. Remove any loose canvas and store in a dry location.
3. Shut and secure all hatches and doors.
4. Make sure the swim ladder is secured in its folded position and that the cover is in place.
5. Check fuel supply levels. Use the fuel "1/3" rule.
6. Turn all battery switches to the "on" position at the sump located battery management panel. Access through the aft port seat which is removable.
7. Make sure all passengers are accounted for, seated and their life jackets are properly fitted.
8. Check for a balanced load.
9. Before disembarking make sure a person is aboard who knows how to operate the vessel and is trained in emergency procedures in case the captain would not be able to carry out his duties.
10. Inspect the engine and drive oil levels. Add specified oil as required.
11. Check engine coolant levels. Add specified coolant as required.

Engine & Controls

TYPICAL STERN DRIVE REMOTE CONTROL



SHOWN IN NEUTRAL POSITION

ELECTRONIC VESSEL CONTROL FUNCTIONS

THROTTLE ONLY BUTTON

SAFETY LANYARD

The typical remote control on your vessel is side mounted at the helm. This control features a handle which can be shifted between forward, neutral (straight up) or reverse positions. Once forward and/or reverse positions are obtained the handle assumes a throttle function to control vessel speeds. The neutral position uses a push button (see photo) for throttle only neutral enhancements. This feature allows the engine to warm up at a higher rpm but in the neutral only position. Note that the engine key switch will not engage the starter (engine will not crank) until the remote control handle is in the neutral detent position.

Note the safety lanyard in the above photo. It is attached to the remote control on one end and to the vessel's operator at the clip end; for example around a belt. Should the operator be dislodged from his helm position the safety lanyard would automatically shut down the engine.

Note that if the safety lanyard is disconnected from the remote control body the engine will crank but will not start.



The remote control is in the forward gear position. Once in the forward gear further movement forward of the control handle will result in forward throttle increases only.



The remote control in the forward gear full throttle position. Comparing the two photos gives the operator a bit of insight into the arc of the forward throttle positions.

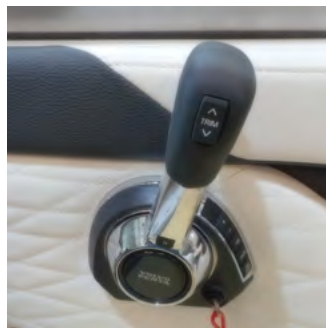

The remote control here is in the reverse gear position. Once in the reverse gear further movement aft of the control handle will result in reverse throttle increases only.



The remote control is in the reverse gear full throttle position. Comparing the two photos gives the operator a bit of insight into the arc of the reverse throttle positions.

Notes: Never shift from forward to reverse while the vessel is planing since this could force water through the exhaust up into the engine. Always shift between gears at idle speeds only.



Refer to the engine operator's manual for more detailed information on EVC and/or DTS remote controls that are used select Volvo and MerCruiser propulsion packages.

We encourage the vessel operator to practice the basic elements of the remote control shift and throttle segments in an open water environment. Once the operator feels comfortable with the remote control functions he should move on to docking and maneuvering in and out of tighter situations such as those found in marinas and launching ramps.

AFTER STARTING ENGINE

1. Allow the engine to idle for a short period as they warm up. Never race a cold engine!
2. Check gauges for proper operation. Pay particular attention to volts, oil pressure and temperature display panel functions as they are key indicators of a proper performing engine. Also, check that no alarms are displayed and no warning lights are flashing.
3. Open the engine compartment and listen to engine for unusual sounds.
4. Inspect the fuel, exhaust, and engine circulation system for leaks.
5. Visually check the entire sump (bilge) for any unusual conditions such as excessive bilge water.
6. Again, check to see that passengers are in life vests, seated and the load is balanced.



WARNING

AVOID SERIOUS INJURY OR DEATH!
GAS VAPORS CAN EXPLODE!
BEFORE STARTING ENGINE
OPERATE BLOWER 4 MINUTES
AND CHECK ENGINE COMPARTMENT FOR
GASOLINE LEAKS OR VAPORS.
RUN BLOWER BELOW
CRUISING SPEED.

NOTICE

TO PREVENT ELECTRICAL SYSTEM
DAMAGE, NEVER TURN "OFF"
THE BATTERY SWITCH
BEFORE IGNITION KEY IS REMOVED.

NOTICE

TO PREVENT A POSSIBLE DEAD
BATTERY, NEVER LEAVE THE
IGNITION SWITCH KEY IN THE "ON"
POSITION WITHOUT THE ENGINE RUNNING.

Engine & Controls

TYPICAL STERN DRIVE ENGINE ROOM OVERVIEW

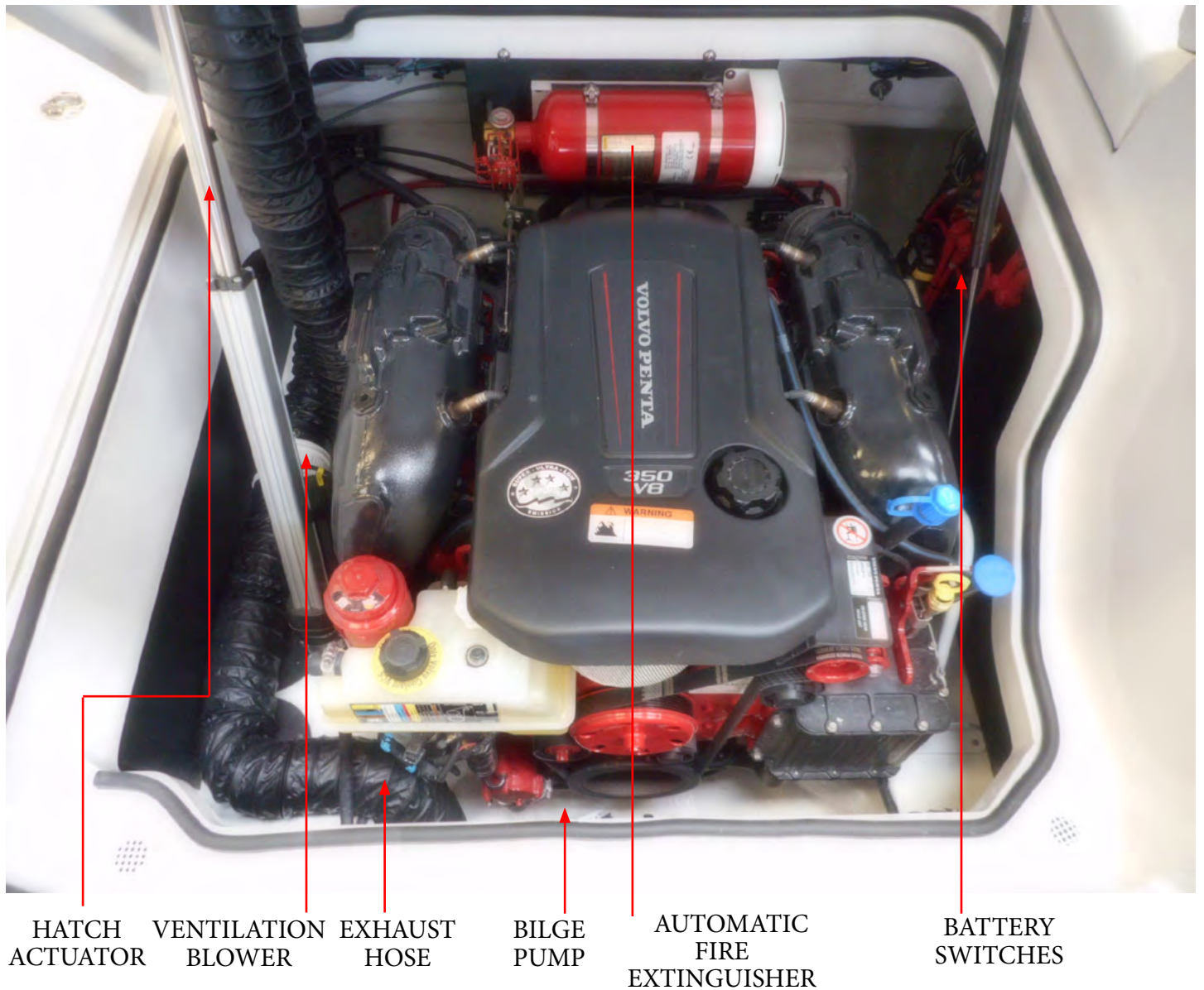

Note: Equipment shown may be optional. Components, systems and locations are subject to change at any time.



CONTROLS/STEERING

Standard engines use remote controls and mechanical helm steering cables along with engine power steering units.

Select engines use “fly by wire” controls which are designed controls without actual cables for shift and throttle control along with steering functions without steering cables running from the steering wheel to the out drive.

These units use hydraulics and special engine software. Read your Volvo or MercCruiser operator’s manual for more detailed information on the system on your vessel.

Volvo “fly by wire” is known as Electronic Vessel Control or EVC. MerCruiser “fly by wire” is known as Digital Throttle & Shift or DTS.

REGAL 26 XO





OUTBOARD HELM OVERVIEW W/ CONTROLS

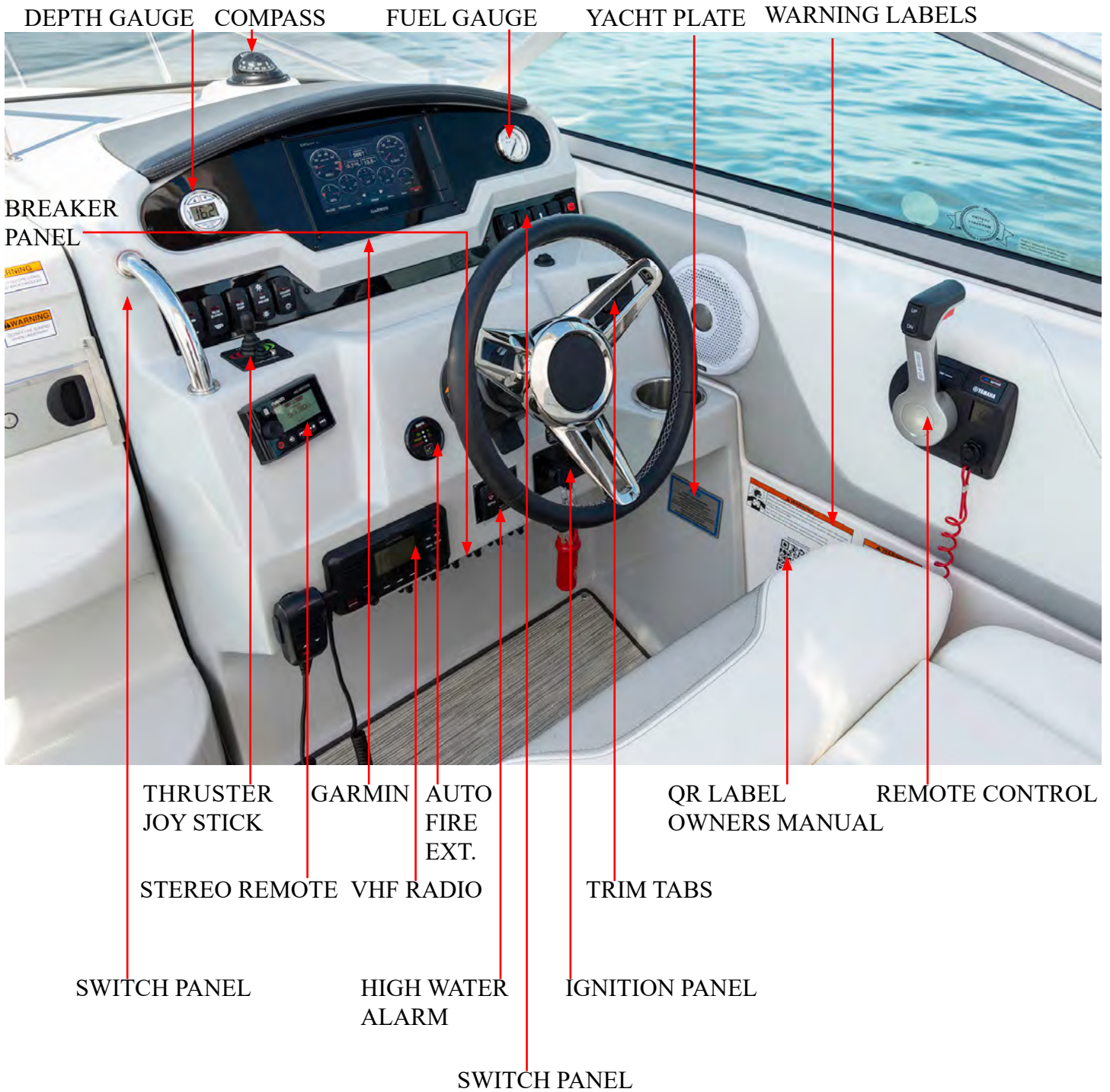

Engine & Controls

OUTBOARD ENGINE & CONTROLS

OUTBOARD OVERVIEW

Note that many of the Regal systems and components are similar between the stern drive. For that reason it is recommended that the operator read the entire manual to become familiar with the various systems.

In this section we will explore various outboard systems and controls that are unique to the OBX model.

This section follows a sequence in operations before starting the engine, starting the engine, and after starting the engine section.



FUEL OCTANE NOTICE

Outboard engines depending on the model may require a mid-range octane level (89) versus a lower regular octane level (87). Refer to your outboard manufacturer's operation manual for correct information regarding the proper octane level for your outboard model.

Using the wrong octane level may cause permanent internal engine damage.

As an option contact your outboard manufacturer's hot line or contact your closest Regal dealer.



REMOTE CONTROL

TYPICAL DIGITAL CONTROL SHOWN IN NEUTRAL POSITION

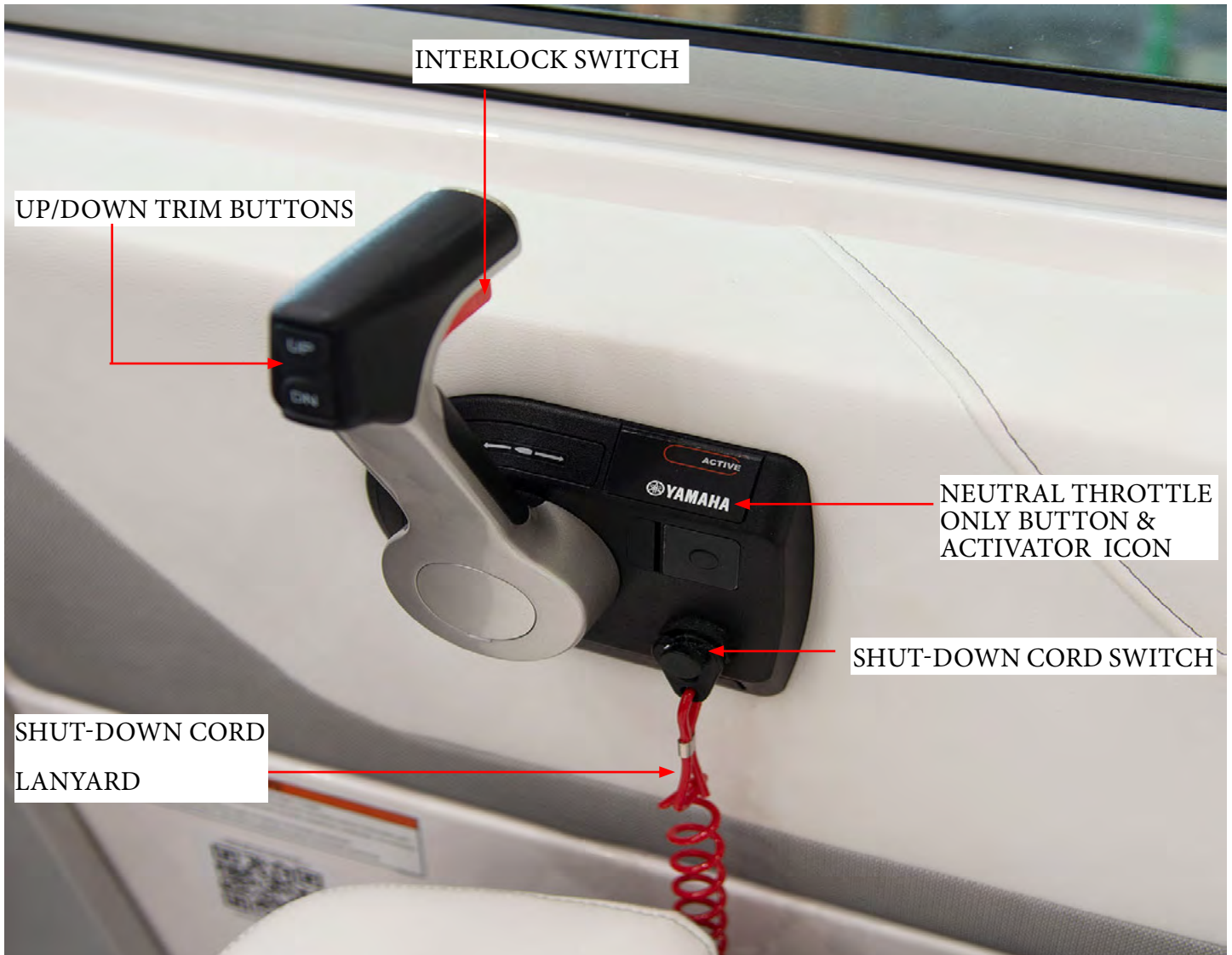

A typical digital outboard remote control is shown above. This control is in the straight up (neutral starting) position. Note that mechanical controls are used on select outboard models.

- The interlock switch prevents starting the engine in gear. It is normally found under the far side of the remote control handle and is colored red. When the engine starts to run the interlock switch must be pulled up and held until the remote control handle can be shifted into forward or reverse gears.
- The up and down buttons control the trim of the outboard in reference to the bow altitude of the boat. Before starting the engine make sure the unit is trimmed to the down position.
- When the neutral throttle only button is pushed in and the control lever is shifted forward the engine speed increases for a faster **neutral** idle. When the control handle reassumes the straight up neutral position after warm up the remote control can be then shifted into forward or reverse gear.

Engine & Controls

- The shut-down cord or safety lanyard is a safety device that when pulled will shut down the engine by interrupting the ignition. It shall be worn by the boat operator anytime the engine is running. Feed the clip around a belt for example or your arm and latch the clip to the cord. Do not use belt loops or clothing as they may not be adequate to hold in an emergency situation. Make sure the shut-down cord is attached to the switch on the control box as the switch upon latching will be in the “on” position. Note that the engine will not start but will only crank with the cord-shut down switch in the “off” position.

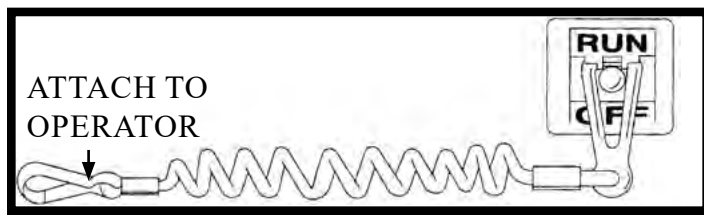

TYPICAL SHUT-DOWN SYSTEM

- Note that the control-activator icon above indicates the remote control is in the “run” or operation mode.



WARNING

AVOID SERIOUS INJURY OR DEATH
DUE TO A RUNAWAY BOAT
IF THE OPERATOR IS EJECTED OVERBOARD!
ALWAYS HAVE THE SHUT-DOWN CORD
ATTACHED WHEN THE ENGINE IS RUNNING.
MAKE SURE THERE IS SLACK IN THE SHUT-
DOWN CORD FOR BODY MOVEMENT.



WARNING

AVOID SERIOUS INJURY OR DEATH!
ENSURE OPERATOR HAS SUFFICIENT SLACK
IN THE SHUT-DOWN CORD WHEN UNDERWAY
IF THE CORD ACCIDENTALLY COMES OFF THE
CONTROL BOX OR ON SOME MODELS THE
HELM SWITCH, WHEN ENGINE LOSES POWER
STEERING CONTROL IS SEVERELY REDUCED.
ALSO, THE VESSEL SLOWS DOWN RAPIDLY
WHICH COULD CAUSE PEOPLE AND OBJECTS
TO BE PROPELLED FORWARD.



← BOW STERN →

FOLLOW THESE TIPS WHEN SHIFTING:

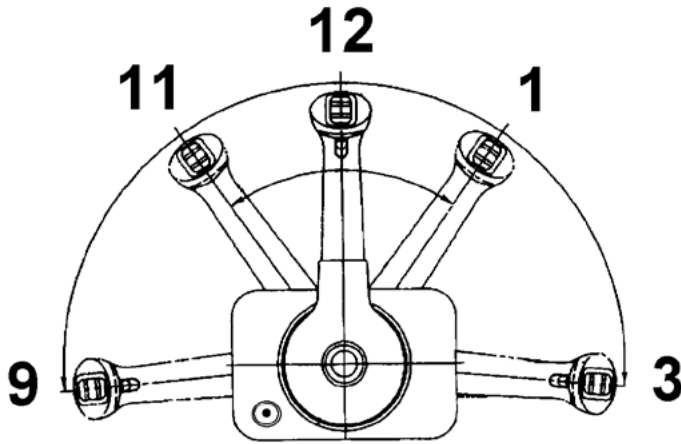

CONTROL WITH SHIFT/THROTTLE POSITIONS

- DO NOT shift quickly from forward to reverse gear positions. Outboard drive system damage may occur.
- DO NOT “pump” the throttle in neutral or flooding will result. The same thing will happen if you keep pumping the automobile accelerator pedal. Today’s engines use direct fuel injection systems that require very little starting throttle.
- DO NOT try to shift into forward or reverse gear at high rpm’s. Personal injury, drive system, or property damage may result.

Use idle only throttle positions in forward or reverse when docking or maneuvering in tight quarters.

Pushing the throttle control lever forward from the neutral 12 o’clock position to the 11 o’clock position will engage forward gear with minimal throttle. From the 11 o’clock position to the 9 o’clock position, the vessel is in forward gear with differing increased levels of throttle selections.

Pulling the throttle control lever back from the neutral 12 o’clock position to the 1 o’clock position will engage the reverse gear with minimal throttle. From the 1 o’clock position to the 3 o’clock position, the vessel is in reverse gear with differing increased levels of throttle selections.

As you shift from neutral to forward or reverse, pull the neutral release button up; this allows the control lever to come out of the indented neutral position.

The control lever features a neutral safety switch which ensures the outboard control is in the straight up neutral position for starting the engine. You will hear a distinct sound and will feel the remote control’s rotation lock, once in the proper position. If you turn the key to the start position and the engine starter doesn’t crank the engine, ensure the control lever is in the neutral position.

Your control lever also features a trim control switch. This switch allows the captain to set the outboard trim position either up or down to achieve a plane position. Refer to the vessel operations chapter for further information on trim angle.

Engine & Controls

BEFORE OPERATING ENGINE

Following are basic instructions and tips before and after starting your outboard engine. For more in depth information refer to your outboard engine owner's manual. Be sure to read and understand all safety labels along with all other related information before attempting to operate your craft.

CHECKING CRANKCASE OIL LEVEL

Remove the shroud (cover) and check the crankcase for proper oil levels. Remember that a 4 cycle outboard uses crankcase oil to lubricate all internal engine components such as crankshaft, rods and pistons along with all related bearings and seals. For changing crankcase oil contact your closest Regal dealer for additional information since they have the special tools and knowledge for these maintenance procedures. Check your outboard owner's manual for correct oil type and viscosity. See figure 1 for dipstick location.

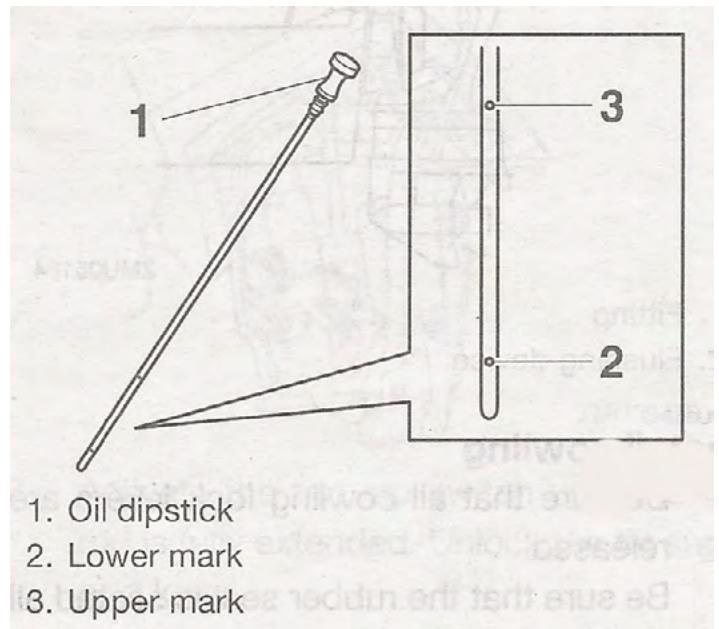

To check the crankcase oil do the following:

1. Ensure the outboard is setting in a flat vertical position or the dipstick may not display an accurate oil level.
2. Remove the crankcase oil dipstick and wipe it clean.
3. Reinstall the crankcase oil dipstick completely into the hole. Remove it again.
4. The oil level should be between the upper and lower dipstick holes. As needed add the manufacturer's recommended oil or contact your closest dealer especially if the oil is contaminated with water which will show a milky color verses a clear or light amber look.

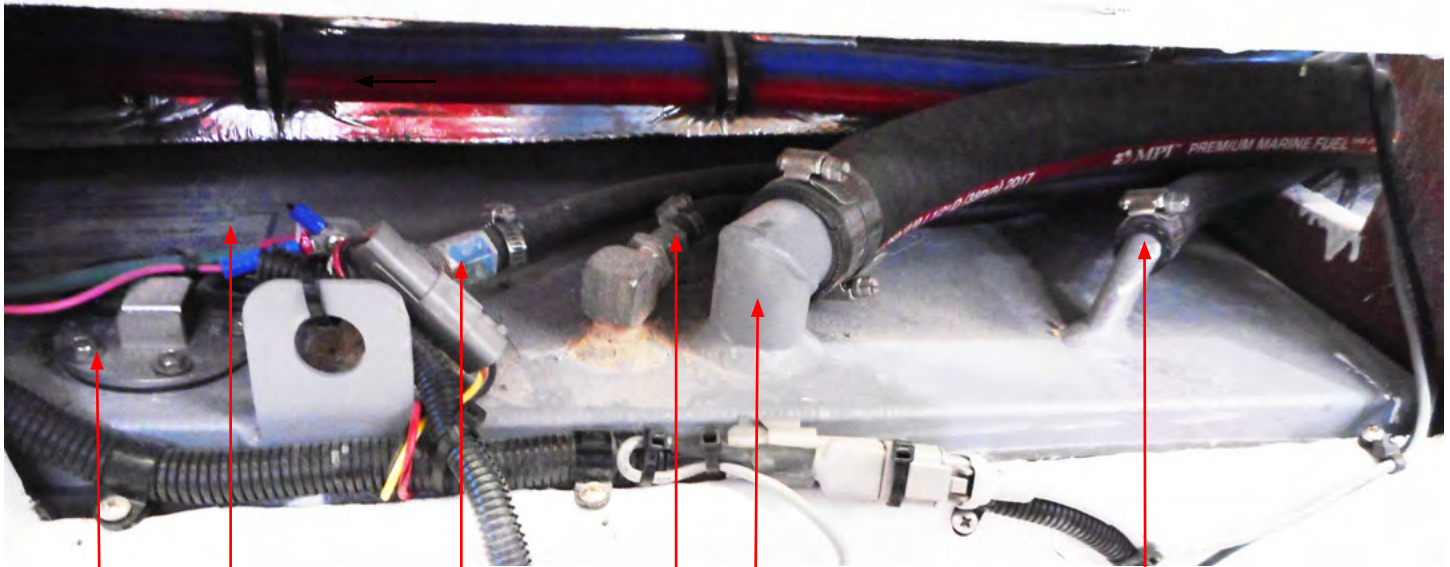

FIGURE 1



CHECKING FUEL SYSTEM

TYPICAL OUTBOARD EPA FUEL SYSTEM



FUEL
SENDER

TANK
LABEL

ENGINE
FEED

GENERATOR
FEED

FUEL FILL

VENT

Before each outing check the fuel tank components including hoses and related clamps. Be sure to sniff for gasoline vapors in the process. If any vapors exist find the source of the leak and repair as needed. At that point ventilate the compartment until vapor smell is gone. Read and understand the following fuel system warning labels.



WARNING

AVOID SERIOUS INJURY OR DEATH
FROM EXPLOSION OR FIRE
RESULTING FROM LEAKING FUEL
INSPECT ENTIRE FUEL SYSTEM AT LEAST
ONCE A YEAR.



WARNING

AVOID SERIOUS INJURY OR DEATH
FROM EXPLOSION OR FIRE!
NEVER STORE FUEL OR FLAMMABLE
LIQUIDS ON BOARD.

Engine & Controls



CHECKING ENGINE MOUNTED FUEL FILTER

As part of select outboards under the motor shroud (engine cover) on the lower port side of the outboard engine is a fuel filter. Periodically check to ensure the fuel filter is clean and free of water. When reinstalling the filter tighten to manufacturer's specifications. Check for leaks after starting the engine. For more information refer to the outboard manufacturer's owners manual or contact a Regal dealer or marine professional.

CHECKING IN-LINE WATER SEPARATOR FILTER



Inside the Lazarett center cockpit storage area a 10 micron in-line water separator filter is installed Use an oil spanner type wrench and turn the filter counterclockwise to remove the element. Using a clean pan empty the filter contents and examine the fuel. Water in fuel tends to hug the

bottom since it is heavier than fuel and will show a different look. At least yearly or on an as needed basis replace the filter element. Fill the element up with fresh unleaded fuel of the correct octane rating (assists with keeping air out of the fuel system) and turn it clockwise by hand until tight. As always check for leaks before starting the engine.

It makes sense to keep extra fuel filters on board in protective wrap for emergency use.



BEFORE FUELING

1. Make sure a working fire extinguisher is available.
2. Stop engines and any device that can cause a spark.
3. Disembark all passengers and crew not needed for fueling.
4. Fuel if possible during the daylight hours.
5. Check to ensure nobody is smoking in the boat or near the fueling dock.
6. Close all portholes, hatches and doors to keep vapors from blowing aboard and settling in the bilge.
7. Tie up your boat securely at the fuel dock.
8. Identify the fuel fill. Unfortunately, people have mistakenly filled the water or waste fitting with fuel.
9. Visually inspect all fuel system components before each filling.
10. Avoid using fuels with alcohol additives. They can attack fuel system hoses and cause deterioration.

DURING FUELING

NOTICE

SINCE GASOLINE IS AVAILABLE IN SEVERAL GRADES INCLUDING ETHANOL & VARIOUS OCTANE LEVELS, REFER TO THE ENGINE MANUFACTURER'S OWNER'S MANUAL FOR THE CORRECT ONE FOR YOUR ENGINE. USING IMPROPER OCTANE FUEL CAN CAUSE ENGINE DAMAGE AND VOID THE WARRANTY.

1. Keep the fuel nozzle in contact with the fuel fill to guard against static sparks. The fuel fill pipe is grounded through the fuel system wiring to protect against static electricity.
2. Avoid overfilling the fuel tank. Leave room for expansion. Overfilling the fuel tank may back fuel up into the carbon canister and possibly cause it to be inoperative.
3. Avoid spilling any fuel. Clean up any fuel accidentally spilled with a clean rag and dispose of it properly.



DANGER

AVOID PERSONAL INJURY OR DEATH!
GASOLINE IS A HIGHLY FLAMMABLE
AND EXPLOSIVE MATERIAL.
PRACTICE "NO SMOKING" AND EXTINGUISH
ALL FLAMMABLE MATERIALS
WITHIN 75 FEET OF THE FUEL DOCK.

Engine & Controls

AFTER FUELING

1. Close fuel fill cap tightly until the two red points line up on the fuel fill cap/casting. This is the proper locked/sealed position.
2. Open all hatches as needed.
3. Sniff in the lower bilge and floor storage locker (shown below) for gas fumes. If fumes are detected continue to ventilate until the odor is gone. Look for any traces of fuel droplets or spillage. Do not start the engine, smoke or run any electrical components until the fumes can no longer be detected.

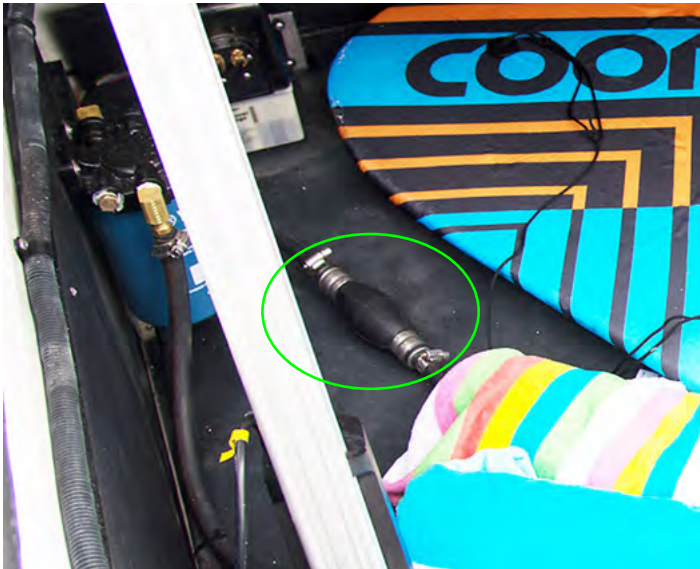

FUEL FILL CLOSED AND POINTS LINED UP

4. Locate the fuel line primer bulb. Hold it at an upward angle and pump it until firm. It may be attached to the output side of the in-line fuel filter. Periodically check the bulb for loose connections especially at the fuel tank and at the engine end. Also, check for signs of cracking on the bulb rubber surface which can develop with humidity and age.

Note that on later models the fuel primer bulb may be connected to the output side of the in-line 10 micron fuel filter.



SYSTEM CHECKS BEFORE STARTING ENGINE

Check these components/systems before starting engine:

1. Tilt the outboard drive and check the propeller for nicks and bent blades which will cause vibration.
2. While the outboard drive is tilted up check for any debris around the water intakes on the vertical drive shaft housing. These could cause the engine to overheat.
3. Check steering system fasteners at the engine and all related hydraulic hoses and connections for signs of leaks including the ones under the helm.
4. While the shroud is off check for any engine oil leakage or fuel puddling.
5. Check engine transom mounting fasteners for tightness.
6. Repair any signs of leakage and loose fasteners and hoses before attempting to start the engine.
7. Ensure that you use the 1/3 rule for determining if you have adequate supplies for the trip. Fill up as needed,
8. Check all throttle and shift cable linkages at power head for tightness.
9. When finished, reinstall the engine shroud ensuring all lock levers are secure.

Engine & Controls

STARTING THE OUTBOARD ENGINE

The following general information covers the starting and stopping of your outboard engine. Read and understand all previous information on remote controls, fueling and operational procedures. Pay particular attention to all danger, warning and caution labels. Refer to the engine owner's manual for in depth propulsion system information.

Review all pre-departure information. Before starting your engine make sure all canvas is in their boots and stored.

Start engine only in a well ventilated location to avoid CO buildup.

Turn the battery switch to the "on" position.

Set the remote control handle in the neutral straight up position. Advance the neutral throttle position as earlier instructed or refer to the engine owner's manual. Connect the safety lanyard to a belt or secure to the arm. Keep passengers seated and away from controls.

STARTING GUIDELINES



Refer to the key switch position photo above.

Turn the ignition key right to the "on" position. This is known as the "run" or ignition position. Turn the key further right to the momentarily "start" position. Since this key position is "spring loaded" you will need to hold it there. You will hear the starter cranking over the engine. When the engine starts release the key switch. It will automatically align itself in the run position (ignition). If the engine does not start refrain from cranking the engine over 10-12 seconds. Allow the starter and battery a chance to recover.

Once the engine starts, advance the remote control in the neutral throttle position as recommended in the engine manual. Let the engine warm up for a few minutes. Do not race the remote control in the neutral position.



AFTER STARTING OUTBOARD ENGINE



POST-STARTING OUTBOARD ENGINE CHECKS

1. Check for a steady stream from the cooling water pilot hole located on the starboard side of the outboard on a casting below the shroud. Water must be flowing at all speeds out of the pilot hole (see photo). A less than steady flow may indicate one of the following:
 - a. Obstruction in the power head water passages
 - b. Worn water pump or plate
 - c. Weeds covering water intakes on vertical drive hsg.
 - d. Pilot hole is plugged with debris. Take a small solid core wire and move it in and out of the pilot hole several times while engine is running. If flow increases the take time to further clean the pilot hole.
2. Let the engine warm up for several minutes listening for any alarms or low oil pressure alerts along with watching the analog helm gauges on selected models. In another scenario the operator can activate the Garmin chartplotter or the RegalVue if installed and program the unit to the engine gauge screen and observe the gauge functions. See the screens on the following pages.

! **WARNING**

AVOID SERIOUS ENGINE DAMAGE!
CHECK THE LOW OIL PRESSURE-ALERT
INDICATOR FOR BLINKING AFTER STARTING.
IF BLINKING SHUT DOWN ENGINE.
INVESTIGATE THE PROBLEM.
CALL YOUR CLOSEST REGAL DEALER OR
MARINE PROFESSIONAL
IF THE CAUSE FOR THE PROBLEM
CANNOT BE FOUND.



Engine & Controls

HELM INSTRUMENTATION

The helm station may be equipped with a fuel or trim gauge and depth gauge along with the ability to monitor engine functions through the Garmin chartplotter or the RegalVue unit if installed. Selected dashes will show analog gauges alone. Close observation of the gauges may save the engine from damage. Gauges do however have some inaccuracy, so do not rely upon them fully.

Note that with the battery switch in the “off” position, there is no power to the helm, including the ignition switch.

All electrical features are protected by a main fuse mounted close to the battery switch. A fuse for the stereo memory and the automatic bilge pump system are also located next to the battery switch in the bilge. The dash switches on the dashboard are protected by a breaker panel located at the base of the helm. Should a breaker “open” it is first necessary to figure out the reason and address the cause before resetting it. If installed the generator blower is protected by its own breaker located below the breaker switch at the ship’s main AC panel.

AUTOMATIC CHARGING RELAY/ M-ACR

Shore power with a battery charger is an option on the outboard model.

Note on outboards with standard dual battery systems there is an automatic charging relay installed on the battery management panel.

The purpose of this device is two-fold. It protects vessel electronics by temporarily isolating house loads from the engine circuit during the engine cranking cycle.

Also, it automatically combines batteries during charging, isolates batteries when discharging and helps prevent house battery voltage spikes and sags. This device supports outboard alternators up to 65 amps. **Remember when charging up a low or dead battery with the ACR and the dual battery switch, you must select the COMBINE BATTERIES section of the dual battery switch for the low battery to recharge.**

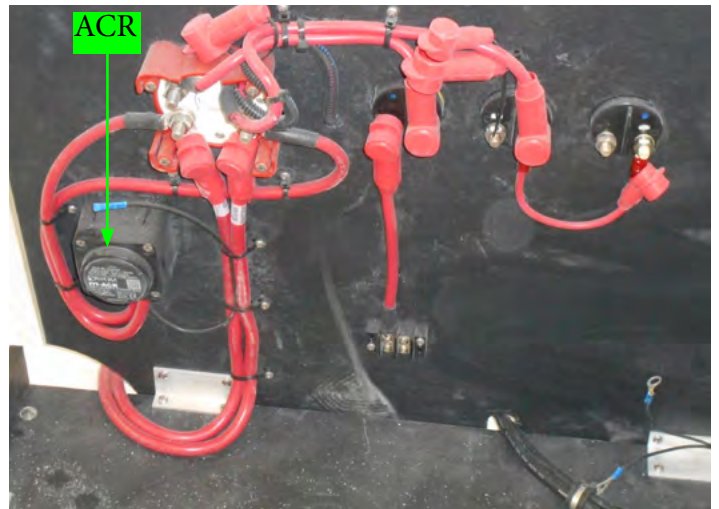

Note not to reverse the battery cables as charging system damage will occur. With DC battery cables connect black to negative and red to positive.



GARMIN ENGINE MONITORING DISPLAY (TYPICAL)



If a Garmin chartplotter is installed on your vessel it features many GPS features along with the ability to monitor engine system functions which may include revolutions per minute (rpm's), GPS speed, voltage, fuel flow rate, trim, and temperature along with tracking engine hours.

Note that the Garmin and Fusion circuitry use individual sources to power up the system. The key switch does not power up these 2 systems. Also, the depth and fuel gauge displays may be independent of the Garmin engine displays.

1. To power up the Garmin GPS press the "on" button located on the upper display.

2. The function AV/Gauges,Controls will appear as one of the choice boxes. Press the box. Another screen with engine will appear.

3. Press the engine box and the engine gauge displays will appear (oil pressure is engine code driven only); fuel display uses dash gauge to display levels).

Engine & Controls

REGALVUE ENGINE MONITORING DISPLAY

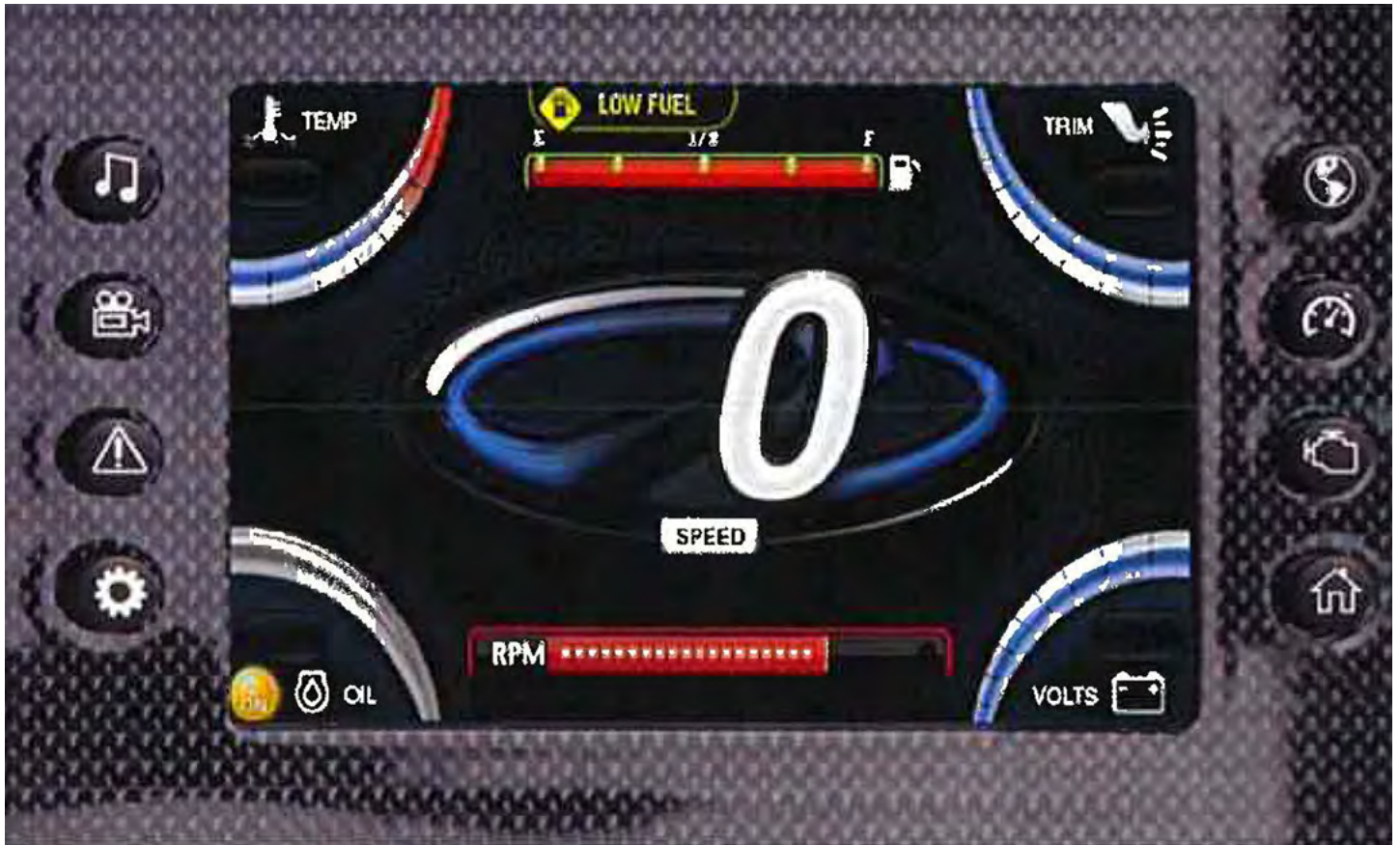

If a RegalVue display is installed on your vessel it features many GPS features along with the ability to monitor engine system functions including revolutions per minute (rpm's), GPS speed, voltage, fuel flow rate, trim, and temperature along with tracking engine hours. The ignition key must be energized for the RegalVue to be programmed or viewed.

The engine statistics can be accessed by pressing the Quick Access Key with the engine icon. This feature displays a summary of engine functions transposed to statistics read by the software as it receives signals from the engine itself.



The display may include:

- Engine Temperature
- Oil Level
- Fuel Level
- Speed
- Engine RPM's (Revolutions Per Minute)
- Trim Tabs
- DC Volts

Note as part of Touch Screen Navigation you will find touch points made up of words or graphics that are highlighted with a soft glow.

SHOW DATA BAR when touched is a popup that will display and maintain the engine data at the bottom of the screen when you are using other screens making it a valuable tool when cruising.

The data bar can be customized in the Data Bar Setting display. Select the number of desired slots to be displayed 3,4, or 5 on the first screen.

After the number of slots have been selected, choose the stats to be displayed and the order in which you want them displayed at the second screen.

Touch (DONE) when finished and the data bar will appear with the changes chosen.

As a safety measure the fuel level indicator is always displayed first and cannot be removed from the display.



Engine & Controls

SHIFTING GUIDELINES-UNDERWAY



Before shifting into reverse or forward gear positions make sure the coast is clear. When shifting to either gear from neutral make sure the throttle is in the idle position.

Warm up the engine at least 3 minutes in neutral before shifting into gear. Before the engine is at operating temperature, the idle speed may be higher than normal. High idle speed can keep you from shifting back to the neutral position.

If this occurs, shut down the engine and shift the gearshift into neutral. Restart engine and allow normal warm-up period.

When ready to shift the remote control lever **out of neutral into gear** move it firmly crisply forward (for forward gear) or aft (for reverse gear) or around 35 degrees you will feel a detent at this point in the forward or reverse gear positions. After this point in the forward or reverse gear position the remote control lever picks up throttle only.

When ready to shift the remote control **from either forward or reverse gear into neutral** pull the throttle slowly from either gear firmly to the straight up neutral position. Be prepared for the vessel to take a few seconds for the vessel to slow headway and to assume an engine idle position.

Practice shifting! You will become more familiar with the procedure and self-confidence will build especially in tight docking situations. Stay alert at all times!



STOPPING VESSEL/OUTBOARD ENGINE

Allow your vessel to lose all headway before shifting from reverse or forward gear into neutral. Do not use the reverse gear function to stop the boat at speeds above idle as it could cause the operator to lose control, be ejected or impact steering wheel functions. Also, it is possible that the vessel could be swamped by taking water over the transom area.

Furthermore, note that bodily injury could occur or damage to the shifting mechanism including the gear case gear unit.

Do not shift into reverse at planing speeds as the operator could lose control or be ejected from the vessel. Remember that the operator is responsible for his passengers! The vessel cannot “stop on a dime” but requires a safe distance to eliminate headway. Of course this distance is effected by water, current, wind velocity and direction, along with the weight of the boat and how it is balanced.

Passengers shall occupy designated seating positions while the vessel is making headway. In addition, make sure everyone including the operator are wearing their life vests.

If possible it is a good idea to fill the vessel at the marina gas dock on the return trip as you will be then ready for the next cruise.

After cruising and returning to your mooring let the engine cool down at an idle position for several minutes.

Turn the ignition key to the “off” position or pull on the safety lanyard cord to stop it. This last endeavor assures that the cut-off system is functioning properly.

Remove the key from the ignition switch. Do not leave the key on the vessel to avoid possible theft. Store at home on a key rack for future use. It is recommended that you put your boat key on a float to prevent submersion and subsequent loss overboard.

When the engine has stopped turn off the battery switch at the battery management panel.

Cover the vessel with appropriate canvas and/or mooring cover if installed.

Engine & Controls

FLUSHING ENGINE OUT OF WATER

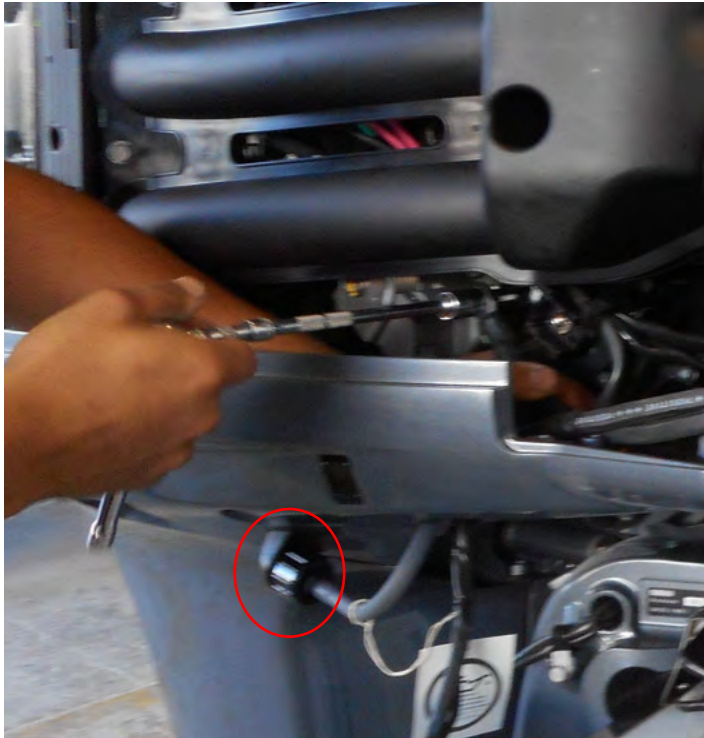

Your outboard features a flushing device which when connected to a garden hose circulates fresh water through the engine to purge unwanted debris such as found in salty, brackish, and silty water.

To use open the flushing device by turning it counterclockwise. Notice there is a garden hose bib thread. Attach the male end of a garden hose to the fitting and tighten it. Make sure the fitting does not leak as the power head could overheat and cause internal damage. It is best to perform this flushing procedure with the engine still warm from a cruise as the thermostat will be open and will permit more efficient water circulation. Turn on the fresh water supply. When flushing completed remove the garden hose from the fitting and reattach the hose connections and check for tightness.

Note that flushing devices that attach to the water intake area of the vertical drive housing can be used with a garden hose to flush the power head. When the water is turned on at the faucet the engine can be started and ran at idle.

These devices also called flushettes can be purchased at marinas, marine speciality stores or can be ordered through the outboard manufacturer. They can be useful for off season fogging of the power head or starting up the engine out of water.

Contact your closest Regal dealer or marine professional for further information and instructions.



OUTBOARD STORAGE/WINTERIZATION

Your outboard has various detailed systems that are affected by extended storage periods. These systems require professional maintenance to protect the components from extended out of use periods especially in freezing climates.

See storage/winterization information in your manufacturer's outboard owner's manual for a listing of maintenance items.

We recommend leaving storage/winterization endeavors to your closest Regal dealer or marine professional. They have the special equipment, parts, lubricants and technical knowledge to perform these procedures correctly the first time.

Engine & Controls

CHECKING STEERING SYSTEM

Your outboard features a mechanical-hydraulic rack style steering system. The unit utilizes valves which permit hydraulic fluid to pass through the system allowing the steering arm at the outboard to turn the vessel to port or starboard. This check valve cluster is located behind the steering wheel. The hardware at both the helm and engine ends must be checked regularly for tightness, lubrication, and leaks. Check the steering system for full steering to port and starboard before disembarking. Typical hydraulic pump shown below. It is located in the aft storage area.

Refer to your outboard motor operator's manual for adding fluid to the pump and type required.

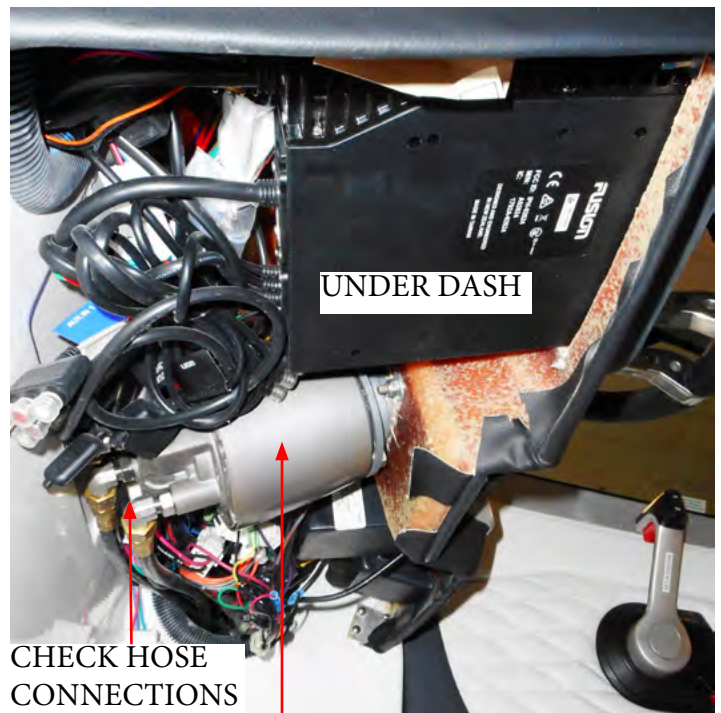

CHECK HOSE CONNECTIONS

HYDRAULIC RACK STEERING CLUSTER



CHECK HOSE CONNECTIONS

TYPICAL HYDRAULIC STEERING PUMP



STEERING HARDWARE & HOSES AT ENGINE



FILLING HELM STEERING RESERVOIR



FILLING HELM HYDRAULIC STEERING FLUID

There is a fill plug located at the starboard helm used to add hydraulic fluid to the steering system. There is a hose kit used to fill the system. See illustration. Note that Sea Star Solutions recommends Seastar Hydraulic Steering Fluid for use with the filler kit.

Any non-approved fluid may cause serious damage to the steering system resulting in possible loss of steering, causing property damage, personal injury or death.

Contact your closest Regal dealer or marine professional for system filling instructions since the steering system may need to be purged of air by opening bleed fittings as the wheel is turned port and/or starboard.

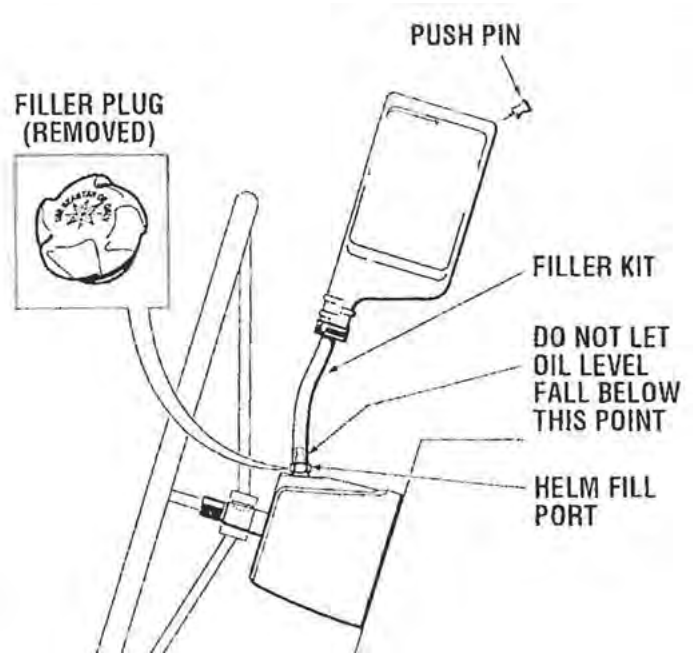

TYPICAL HYDRAULIC STEERING FILL KIT



WARNING

AVOID SERIOUS INJURY OR DEATH!

THE OPERATOR OF THE CRAFT
MUST HAVE COMPLETE CONTROL
OF THE HELM STEERING STATION
WHILE THE VESSEL IS MOVING.

NEVER LEAVE
THE HELM STATION UNATTENDED
WHILE THE VESSEL IS MOVING.

Engine & Controls

SEA STAR STEERING SYSTEM SCHEMATIC OVERVIEW

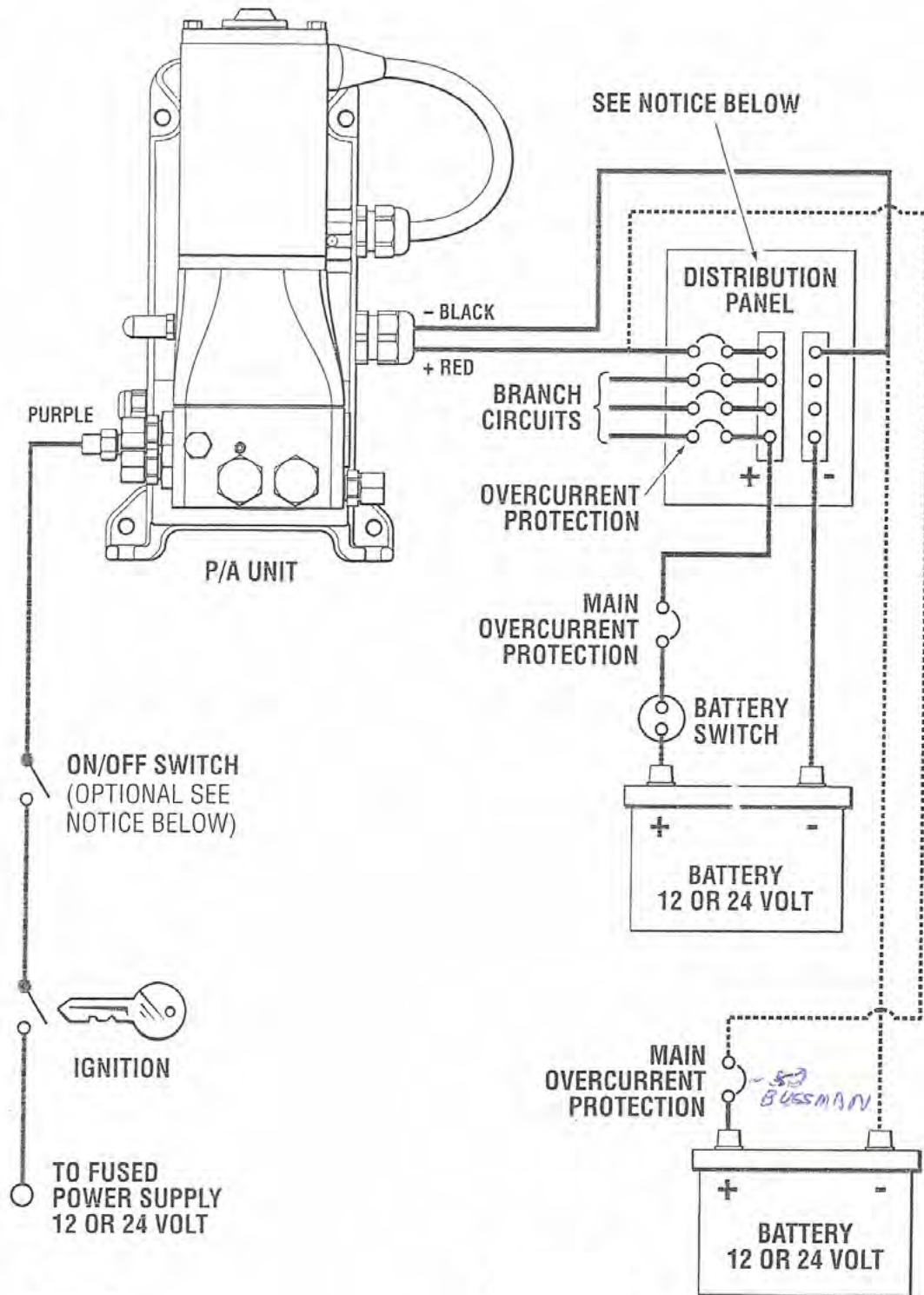



TYPICAL OUTBOARD GENERATOR (GEN-SET)

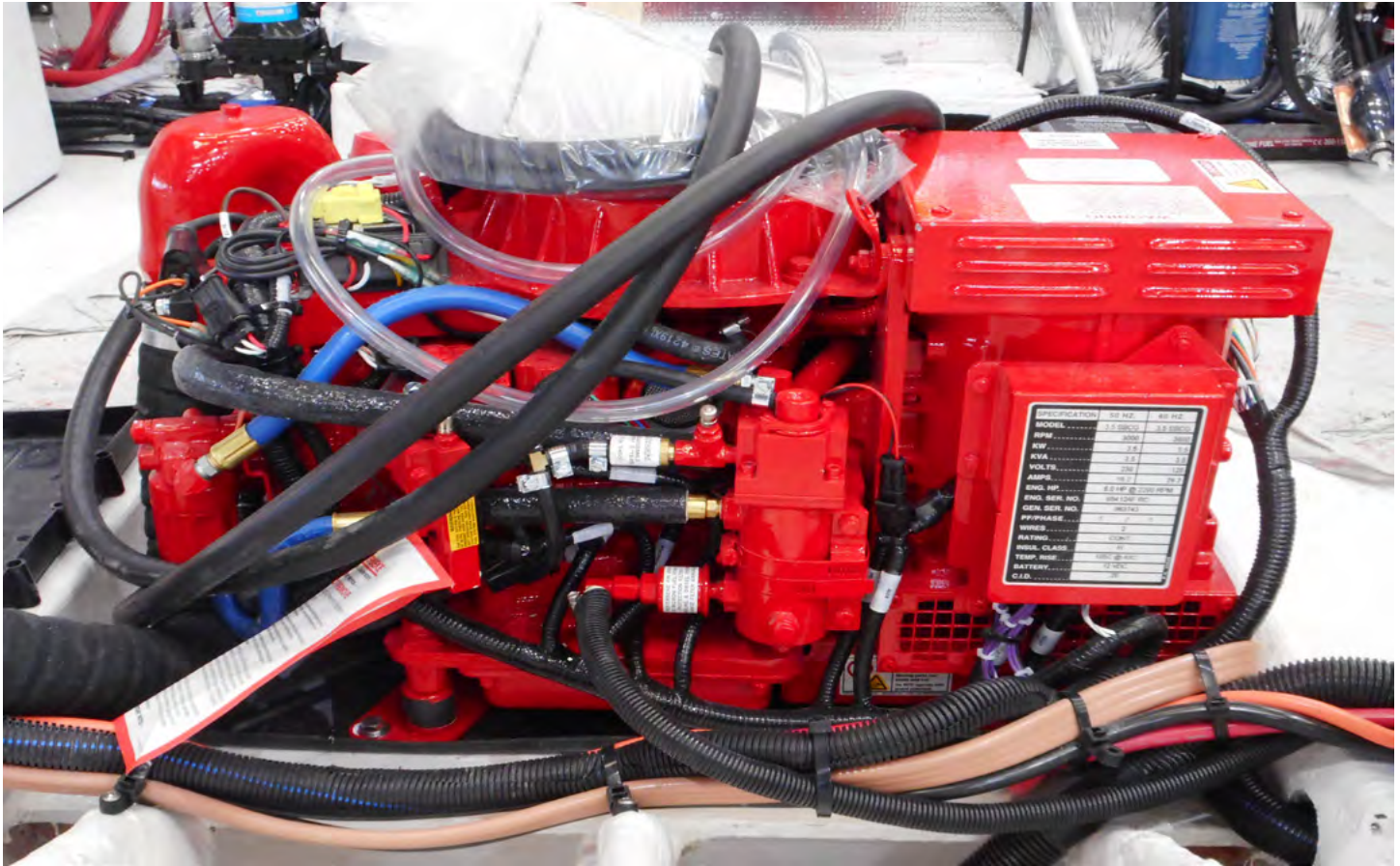

OVERVIEW

If installed the generator (gen-set) is used to provide on board alternating current (AC) when the vessel is unplugged from the dockside cord. Generator frequency known as hertz is domestically set at 60 while overseas countries normally require a setting of 50. As the generator reaches full rated no load output (amps) at 60 hertz it should display 120 volts. At 50 hertz it should display 230 volts.

The generator option is located in the bilge. For further detailed information refer to the generator operator's manual or contact your closest Regal dealer.

Note that outboard vessels with the generator option will include an automatic fire extinguishing system.

Typical Generator Fuel System

The generator is supplied by the same fuel tanks as the engines. The generator feed valve/anti-siphon valve at the fuel tank itself is normally visually smaller than the engine feed valve. Familiarize yourself with the location of all equipment and valves.

Note: Normally the generator feed is a 1/4" inch barb fitting located on the fuel tank. The feed portion will include an anti-siphon valve.

The fuel system features an in-line fuel filter located close to the generator. It's job is to keep fine particles and water out of the generator fuel system. Refer to the vendor information for periodic maintenance schedules. Clean fuel is the life line of generator performance.

Engine & Controls

Generator Specifications (Typical)

SPECIFICATION	50 HZ.	60 HZ.
MODEL	3.5 SBCG	3.5 SBCG
RPM	3000	3600
KW	3.5	3.5
KVA	3.5	3.5
VOLTS	230	120
AMPS	15.2	29.2
ENG. HP.	6.0 HP @ 2200 RPM	
ENG. SER. NO.	65412AF RC	
GEN. SER. NO.	963743	
PF/PHASE	1 / 1	
WIRES	2	
RATING	CONT.	
INSUL. CLASS.	H	
TEMP. RISE	105C @ 40C	
BATTERY	12 VDC	
C.I.D.	20	

Note that the generator itself and specifications may change at any time.

Generator In-Line Fuel Filter



Since water is heavier than fuel it will settle at the bottom of the water separator filter. Periodically check the filter for foreign debris and water in the fuel supply. To check the filter unscrew it using an oil filter type wrench that fits on the bottom. Do not use a strap type wrench since it may distort or damage the filter housing. Use an environmentally safe container to catch any contaminated fuel. If needed, dispose of according to local, or state regulations. Carry extra water separator filters on board. When you turn the filter upside down to dump the gas note that any water in the gasoline will gather at the bottom of the container since it is heavier than gasoline and will appear as a different color and consistency and normally will move back and forth independently from the gasoline mixture in the container. After inspection spin on the filter and hand tighten only. Start the engine and check for fuel or air leaks.



Typical Electrical System

The generator starting system uses the port cranking battery. The generator is normally started at the 12 volt ship's control panel located in the salon but it can also be started using the remote instrument panel located at the generator itself as needed. The latter is especially useful while maintenance is being conducted. The generator remote instrument panel features temperature, oil, DC volts, hour meter gauges and on/off, start and stop switches. The starting switches can be reached through an access panel at the sound shield.

The start and stop switches by name and function are identical to the switches on the remote panel.



TYPICAL GEN-SET SWITCH CLUSTER- MAIN PANEL

Note the illustrations showing the remote instrument and start panel. As part of the generator electrical system a fuse protects the remote instrument panel wiring circuit. See illustration B.

Above the fuse is a switch. This switch must be in the "run" position or the generator will not start. The emergency stop switch shuts the fuel off to both the remote and ship's main control panel and is normally for maintenance purposes. See illustration B.

A DC manual reset breaker protects excessive current draw or electrical overload anywhere in the generator engine wiring. Should this breaker trip the generator will shut down. Reset the breaker only after the cause of the problem has been determined. See illustration A. An AC breaker will automatically disconnect any generator AC power from reaching the main ship's control panel in case of an electrical overload. It can be manually shut off when performing generator maintenance to ensure no AC power is coming out of the generator. See illustration A.



ILLUSTRATION A

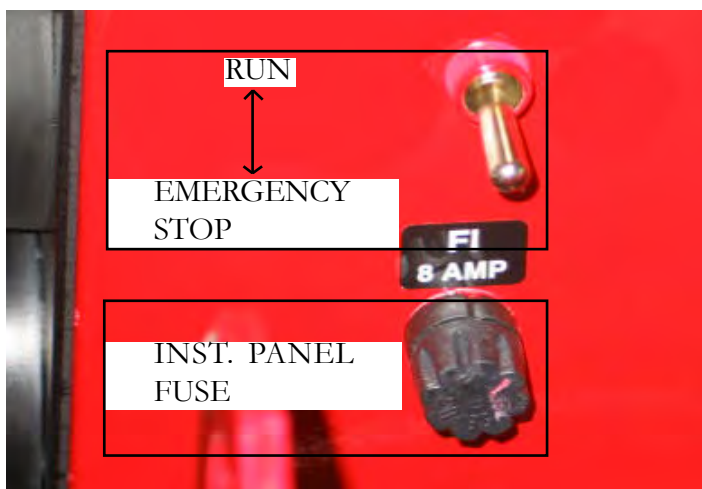

ILLUSTRATION B

NOTICE

TO PREVENT POSSIBLE GENERATOR DAMAGE ALL SHORE POWER BREAKERS AND AC SWITCHES NEED TO BE DEACTIVATED BEFORE STARTING OR STOPPING GENERATOR.

Engine & Controls

Typical Exhaust System

The generator exhaust system features a dual tier operation. As the water and exhaust exit the generator they travel to the muffler. The muffler discharges the heavier water out the muffler bottom and through the hull. The exhaust itself is exited out the muffler top and through the hull. The benefits of the system are two-fold. First, the actual decibel or sound level is decreased. In addition, the lower resonating sound is more pleasing to the ear. For colder climates, a drain plug is installed in the muffler.

TYPICAL GENERATOR MUFFLER

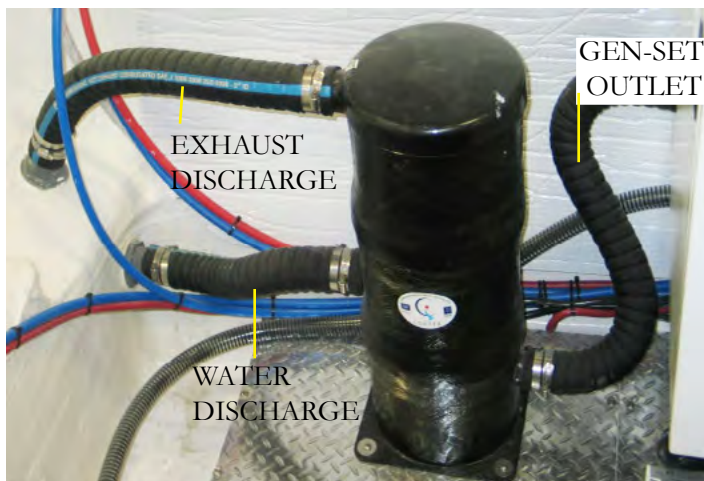

Before departure always check the hose connections for signs of water and air leaks. Tighten hose clamps as needed.

Before Starting Generator

The following items should be checked each time before starting the generator. This covers the basic system components.

- ✓ Turn generator seacock off. Check strainer for debris. Turn generator seacock on before starting generator.
- ✓ Ensure that all main panel and equipment breakers are off.
- ✓ Inspect the generator for fuel, oil, exhaust or water leaks.
- ✓ Check generator engine oil level. Top off with correct viscosity as required.
- ✓ Check coolant for proper level at recovery tank. Add as needed.
- ✓ Check the main fuel tank to ensure there is adequate gasoline for both the generator and the engines. Apply the one-third rule.
- ✓ Check for loose wires at the alternator.
- ✓ Check the port side cranking battery (weekly).
- ✓ Check drive belts for wear and proper tension (weekly).
- ✓ Record the hour meter reading to meet maintenance scheduling.

Note to check the blowers for proper operation. Start blowers and let run at least 4 minutes before attempting to start the generator. Run blowers continuously while generator is running.



TYPICAL OUTBOARD GENERATOR MAIN PANEL CONTROLS

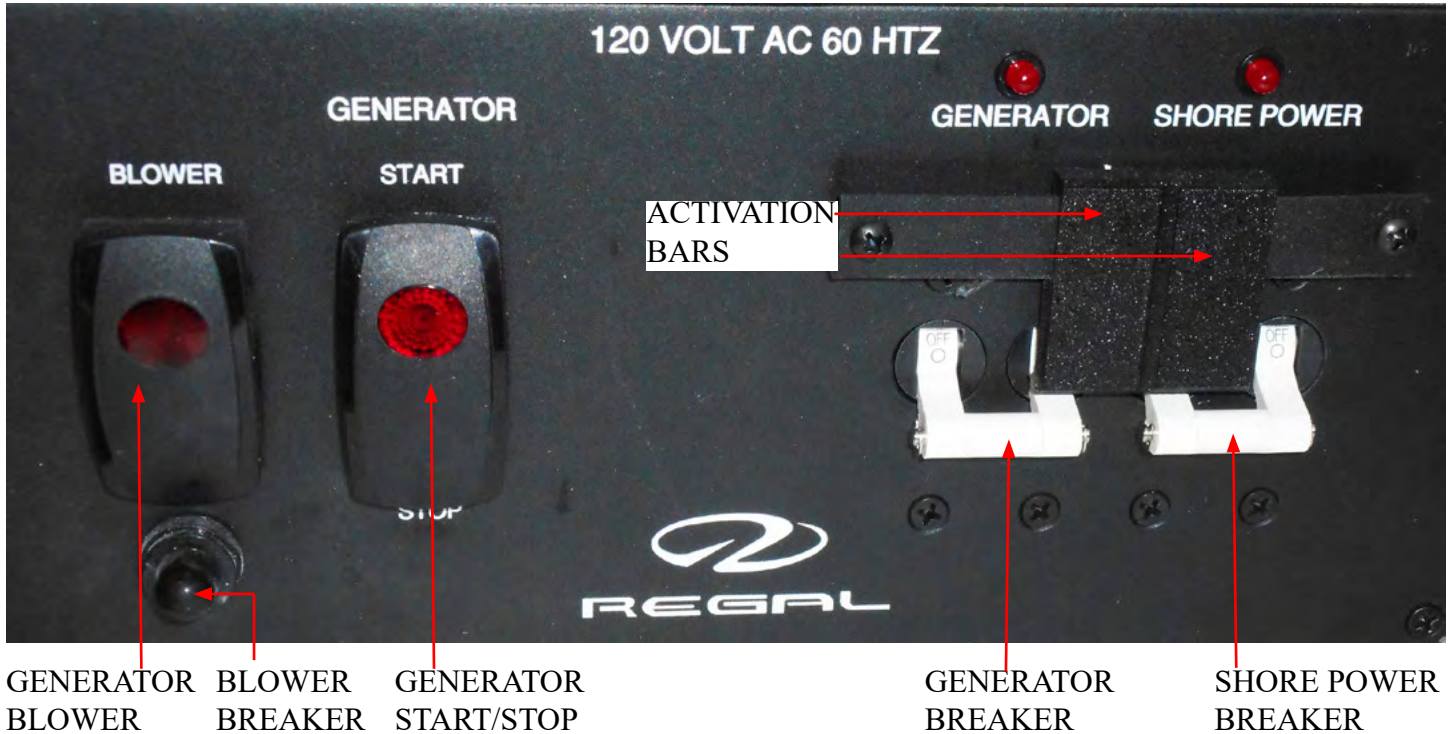

Starting Generator

The following generator starting information is specified for use at the ship's main control panel. It also assumes that the checklist on the last page has been completed and all system components are in good operational condition. For further information refer to the generator manual.

1. Turn the generator seacock handle to the "open" position in the sump (bilge).
2. Check the ship's main control panel to ensure shore main and all equipment breakers are deactivated.
3. At the ship's main control panel find the generator start/stop switch. Depress the "start" portion of the switch and hold approximately 4 to 5 seconds. See location above.
4. This will engage the generator starter to crank over the gen-set engine. Release after starting. If generator does not start wait several minutes and retry start procedure.

5. Once the generator starts, release both the "start" portion of the switch.
6. Let the generator run without a load for several minutes.
6. At the ship's main control panel slide both activation bars to starboard. Flip the generator breaker up to energize the generator side of the circuit. At this point AC voltage should display on the AC line voltage meter.
7. Now it is safe to activate the desired AC equipment breakers.

Note above the generator and shore power breakers are circuit icons which are lighted depending which circuit is energized.

Engine & Controls

Stopping Generator

To stop the generator follow these steps at the ship's main control panel;

1. Turn to the "off" position all AC equipment breakers.
2. Flip the generator breaker to the "off" position. At this point, no AC line voltage will be displayed at the AC volt meter. Let the generator run for 3-5 minutes without a load to cool down.
3. Stop the generator by pressing down the "stop" portion of the switch at the main panel generator switch cluster. Hold it down until the generator stops running.

POSSIBLE PROBLEMS/SOLUTIONS



1. With generator main control panel activated there is no voltage at the AC line voltage meter. Check AC output breaker on the generator. It may of tripped due to an overload.
2. The generator quit do to overheating. Check the generator strainer for obstructions such as seaweed, plastic, or shellfish. Be sure to turn off sea cock before removing the strainer basket.
3. The generator will not start from the main ship's panel after being serviced. Make sure the generator mounted switch is in the "run" position.
4. The generator will not crank over to start. Check the port cranking battery by starting the port engine. If it starts battery is up. Then check all generator battery connections. Tighten any loose connections.

Vessel Operation



This chapter explores select parts of running your vessel from casting off to docking and handling emergencies. We recommend further reading to enhance your information on the chapter

topics. Also, become familiar with your engine owner's manual since many of the items noted here are found there in further detail.

GETTING UNDERWAY

Pre-Departure Questionnaire

- Have all fluid levels been topped off?
- Is the fuel tank full?
- Are the propellers in good condition?
- Is the drain plug in place (dry stored vessels)?
- Have all passengers been briefed on all emergency procedures and seated for departure? Is the boat load balanced?
- Is all safety equipment accounted for and easily accessible?
- Are navigational lights and sound signals in good working condition?
- Is the bilge free of water and do the bilge pumps operate properly?
- Is the operator sober, alert, and ready to skipper the vessel?
- Have all passengers been fitted for the proper sized life jackets?
- Has a float plan been filed with a component person?
- Has the bilge been sniffed and the fuel system leak checked?
- Are the appropriate sea cocks open?
- Is all communication in good operating condition?
- Has a second person been briefed on operational, emergency, and VHF procedures should the skipper become disabled?

Vessel Operation

- Are all gauges and electrical switches functioning properly?
- Has weather information been gathered and analyzed?

UNDERWAY QUESTIONNAIRE

- After casting off have all dock lines and fenders been stowed?
- Are all passengers seated?
- As skipper are you monitoring the dash gauges and chart plotter for changes?
- As skipper are you on the lookout for changing weather?
- As skipper are you checking for abnormal vibration or steering?

DISEMBARKING QUESTIONNAIRE

- Have you removed the keys from the ignition and secured them?
- Have all systems been checked for leaks?
- Have the battery switches been turned to the “off” position?
- Are all storage compartments and seacocks closed?
- Has the fuel tank been filled enough to assist in preventing condensation?
- Is the vessel properly tied and covered with equipment stored?



WARNING

PRACTICE “NO SMOKING” AND EXTINGUISH ALL FLAMMABLE MATERIALS WITHIN 75 FEET OF ANY FUEL DOCK.



WARNING

PREVENT INJURY OR DEATH FROM FIRE CAUSED BY LEAKING FUEL. INSPECT ENTIRE FUEL SYSTEM AT LEAST ONCE A YEAR.



WARNING

TO PREVENT INJURY OR DEATH USE ONLY GENUINE MARINE ENGINE/DRIVE REPLACEMENT PARTS



BEFORE FUELING

Note: To be extra safe the skipper should follow the procedures below for fueling diesel that are normally defined for petrol. Gasoline exhibits much greater flammable/explosive characteristics but diesel can ignite and burn under the right conditions.

- Make sure a working fire extinguisher is at close hand.
- Stop engine while fueling.
- Disembark all passengers and crew not needed for fueling.
- Fuel if possible during the daylight hours.
- Check to ensure nobody is smoking in the boat or near the fueling dock.
- Close all enclosures to keep vapors from blowing aboard and settling in the bilge.
- Tie up your boat securely at the fuel dock.
- Identify the fuel fill.
- Visually inspect all fuel system components before each filling.

DURING FUELING

- Keep the fuel nozzle in contact with the fuel fill to guard against static sparks. The fuel fill pipe is grounded through the fuel system wiring to protect against static electricity.
- Avoid overfilling the fuel tank. Leave room for expansion.
- Avoid spilling any fuel. Clean up any fuel accidentally spilled with a clean rag and dispose of it on shore.

AFTER FUELING

- Close all deck fuel fill caps tightly or until they ratchet with EPA systems.
 - Open all hatches.
 - Sniff in the lower bilge and engine compartment for diesel fumes. If fumes are detected find the cause of the diesel odor until the odor is gone. Look for any traces of fuel droplets or spillage.
- Do not start the engines, smoke or run any electrical components until the fumes can no longer be detected.**

STARTING & STOPPING

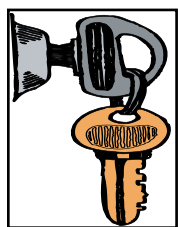

The following general information covers starting and stopping your engines. Read and understand all previous information on remote controls, fueling and operational procedures. Pay particular attention to all labels. Refer to the engine operation manual for in-depth propulsion system information.

Review all pre-departure information. Before starting your engines make sure all canvas is removed and stored. Start engines only in a well ventilated location to avoid diesel exhaust buildup. Make sure all battery switches are activated. Close and lock the center windshield section.



WARNING

AVOID PERSONAL INJURY OR DEATH!
WHEN ENGINE IS RUNNING
TRANSOM DOOR MUST
BE CLOSED AND LOCKED.
SWIM PLATFORM
AND LADDER MUST NOT BE IN USE.



WARNING

AVOID SERIOUS INJURY OR DEATH!
THE OPERATOR OF THE CRAFT
MUST HAVE COMPLETE CONTROL
OF THE HELM STEERING STATION
WHILE THE VESSEL IS MOVING.
NEVER LEAVE THE HELM
STEERING STATION UNATTENDED
WHILE THE VESSEL IS MOVING.

STARTING GUIDELINES

Position the remote control handles in the neutral position. Keep passengers seated and away from controls.

Note: With earlier models the Volvo EVC-D control station will be activated once the ignition key is in the “ON” position (key position I) At this point the neutral “N” icon will display a green light .

Next, turn the key to the start position (key position III). You will hear the starter cranking over the engine. When the engine starts release the key switch. If additional cranking attempts are needed, the key must be returned to the **0** position first.

If the engine does not start, refrain from cranking the engine over 10-12 seconds. Allow the starter and battery a chance to recover. Advance the remote control in the neutral throttle position only as recommended in the engine manual. Do not race the remote control in the neutral position.

On later EVC-D systems, turn the key to the “ON” position and then to the start position. Release the key. The starter will continue to crank until the engine starts.

With this system once the keys are engaged in the automatic start position they are disengaged if you try to turn them again to the start position.

On the newest Volvo engines a key fob system is used to start the engines. The system uses two main parts; the key panel and the key fob. Two key fobs come with dual engine installation along with a 2.5” key panel. The key panel uses lighted icons to show active ignition and start/stop positions. Theft protection is vastly improved with the E-key system.

If the starter stays engaged for more than 30 seconds the circuit is automatically cut to protect the starter from overheating. If this happens, let the starter cool for several minutes before attempting to restart the engine.

Note: With all the above systems, refer to the Volvo operator’s manual for further information.



SHIFTING GUIDELINES

Before shifting into reverse or forward make sure the coast is clear. When shifting to either gear from neutral make sure the throttle is in the idle position. Do not pause but engage the shifter quickly into the desired gear. Allow your vessel to lose all headway before shifting into reverse or forward gear. Practice shifting! You will become more familiar with the procedure and self-confidence will build especially in tight docking situations. Most importantly, stay alert! When maneuvering into a tight slip or pier be sure to use the IPS joystick “docking” button. If the current or wind is strong use the joystick “high” button which will supply increased idling speeds.

STOPPING GUIDELINES

Before stopping the engines make sure they are in neutral and at idle speed. After an outing let the engines cool down by idling for a few minutes before turning the ignition off. Glance at the gauges one last time to monitor their readings. Never turn the engine off while in forward or reverse gear or back up in excessive speeds since water could enter the engine through the exhaust system and cause extensive damage. Above all, use common sense.

CAUTION

AVOID ENGINE DAMAGE!
CHECK THE OIL GAUGE IMMEDIATELY
AFTER STARTING ENGINE.
IF LOW OR NO READING
SHUT DOWN ENGINE IMMEDIATELY
AND INVESTIGATE THE PROBLEM.

CAUTION

TO PREVENT INJURY DUE TO FALLING
DO NOT OCCUPY SUNPADS WHILE
VESSEL IS MOVING!

FENDERS

FENDER USAGE



Fenders are normally made of a rubberized plastic and are usually filled with air. Most have a fitting like a basketball so they can be inflated or deflated. Fenders are available in a wide range of sizes and shapes to fit both small and large vessels. Fenders are normally designated in inches. They are used for protection between piers, docks, sea walls and the vessel. They protect the topsides of the boat from rubbing against rough objects. Most fenders have attachment eyes which allow a line

to be inserted vertically or horizontally. This will permit the fender to be tied off to fit individual dock and tidal situations. Be sure the fender is correct for the vessel size. The standard fenders specified for your Regal yacht are 10” in diameter and 26” long. It is a good idea to carry extra fenders but half a dozen is normally an acceptable number. Remember to store fenders on board so they can be easily accessed. The forward stairway locker stores 2 fenders. Sometimes people call fenders “bumpers” but this is not correct nautical terminology.

FENDER TYPES



Additional yacht fenders can be ordered through your Regal yacht dealer. Explain how you moor and use your vessel so your dealer can recommend the best fender type for you. We suggest the type with a fill plug so you can inflate them with a hand pump like the ones used for bicycles or a 12 volt compressor (plugged into the 12 volt vessel accessory plug).

Vessel Operation

DOCK LINE BASICS

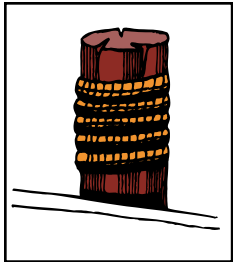

Most skippers use dock line terminology fairly loose but there is more to the basics than just bow or stern lines. There are several lines that can be secured to the bow and stern and depending on their direction and use, can be called other names. Remember that “forward” and “aft” refer to the direction that a spring line runs from the vessel, and not where it is secured on board.

BOW AND STERN LINES

There is only one true bow line. It is secured to the forward cleat and run forward along the dock to prevent the vessel from moving to the stern. The stern line leads from a rear cleat to a piling or cleat on the dock astern of the vessel. This line keeps the boat from moving ahead. For small vessels these are the only lines needed for normal wind and current conditions. If located in a tidal environment, keep slack in the lines.

BREAST LINES

These lines are attached to the bow and stern that lead to nearly right angles from the center of the vessel to the dock. They help keep larger vessels from moving away from the dock, or are pulled in to help people board the vessel. Bigger vessels may use bow or quarter breast lines.

SPRING LINES

Most boats use two spring lines although it is possible to have four. They are called the after bow spring and forward quarter spring.

Bow springs are secured at the vessel’s bow area. Forward spring lines lead forward from the boat to the dock and control movement stern ward. After springs stem aft from the vessel, and stop movement ahead. Spring lines are used to prevent movement in a berth, ahead or astern. They are really useful in controlling the effects of a real active tidal surge. Spring lines are useful where fenders need to be kept in place against piles.

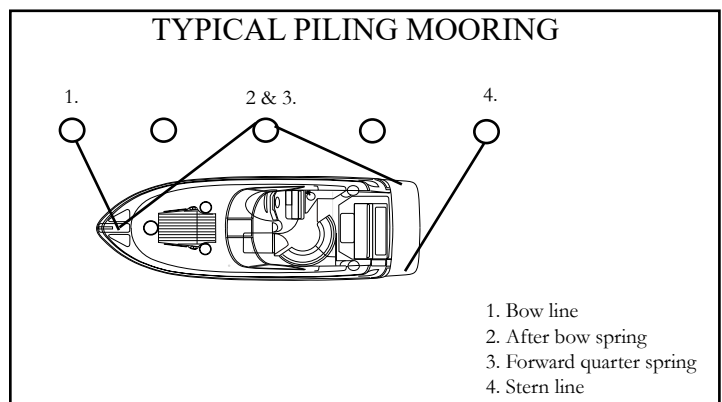
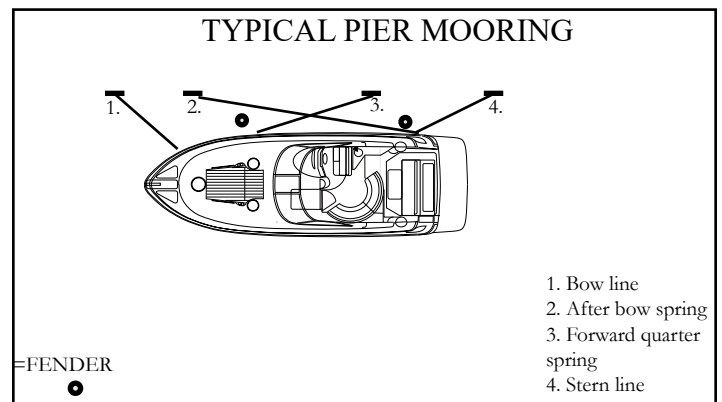

BOAT MOORING

Most boats can be secured to a dock using four lines. The after bow spring is crossed with the forward quarter spring and secured to individual dock cleats or pilings. This ensures longer springs and can be snugged up tighter for more efficient tidal control. Remember, if you only have one piling available, position the vessel so this point is opposite amidships. Run both spring lines to it. These lines will be shorter but still useful.



The bow and stern lines should be relatively at a 45 degree angle with the dock. The stern line can be attached to the near-shore quarter cleat, but will work more efficiently to the offshore quarter cleat. The longer line will allow the boat flow with the tide with less time checking the vessel.

DOCK LINE SIZING

Most dock lines today are made of nylon, either of twisted rope or braided core and cover. The most often used material is nylon because of its stretching abilities absorbing shock loads. It is chafe resistant for extended life and is easier on bare hands.

The line's size varies with the vessel. Normally, a vessel in the 50' range will use 5/8" diameter nylon lines.

Dock lines need to have the strength to hold the vessel and have enough density to resist chafing. They shouldn't be too heavy that they lose their shock-absorbing capabilities. Use the right size line for the vessel since a line too large for the boat will pull hard against the vessel since it won't be forced to stretch. If the line is too small for the vessel, there is no margin for wear and chafe when under strain.

SECURING LINES

When mooring your boat, make sure the dock lines are secured at both ends. Depending on your situation you may need to loop the eye splice of the dock line around a piling. Sometimes the mooring line will lead down sharply from the piling to the deck cleat. Loop the eye splice around the piling twice to keep it from being pulled up off the pile. Pull the line through the looped eye if the mooring line is too small to go around the piling twice or too small to fit over once.

If you must drop a line over a piling that already holds another boat's line, run the eye of the line up through the first eye from below, then loop it over the pile. This will allow either line to be removed without disturbing the other. If another line is dropped over yours, simply reverse the process.

Secure a little slack in the other dock line, then slip your eye up through its loop and over the top of the pile. Your line can be dropped through the other eye.

Note: Never use the swim platform cleats for permanent mooring cleats.

DISEMBARKING-LEAVING THE DOCK

When debarking from a dock, it is easier to release the line from a cleat or piling, from on board the boat, as soon as you leave the dock. Loop a long line around the cleat or pier and leading both ends on board you can release the line easily. Slip one end around the cleat or pile, then pull it back on board. Release the line without the eye splice, so it will run freely from around the pile without hanging up on the splice.

KNOTS

Knots are useful in docking, towing and other emergency situations. Learning to tie knots requires practice. As they say “Practice makes perfect”. Some of the knots used in boating are the square, bowline, anchor bend, clove hitch, figure eight and half hitch. There are several periodicals available that explain various knots and how to tie them effectively. An experienced skipper will know the basic nautical knots and will use them when on the water. Take the time to know the basic knots.

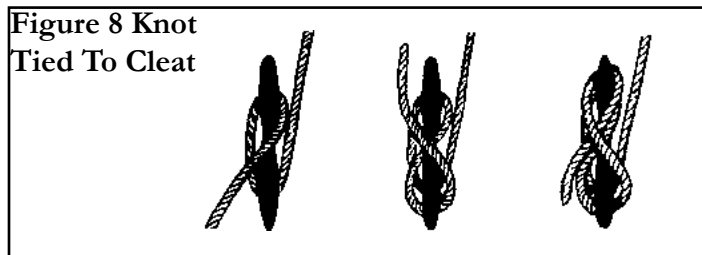

A useful knot to learn for general docking is the figure eight with one end reversed. By turning the free end of the line back under, the knot can be released without disturbing the boat. After some practice one person can secure a vessel easily to a dock or pier in a variety of weather conditions. This knot normally is used to tie the bow and stern. Then the vessel can further be fastened by tying the spring lines in the figure eight knot. Wrap it around the cleat 2 or 3 times.

DOCKING-GENERAL

As a general note docking and slow speed maneuvering can be one of those operations many skippers dread. The IPS joystick with a little practice makes you look like a pro while docking your vessel in wind, current, and tight mooring situations.

Read your engine manual to become familiar with the joystick and remote control components. It is a good idea to practice your beginning docking techniques in an open area. Remember practice makes perfect!

Helpful hints using the joystick;

1. For better control hold the joystick knob lightly almost like you would a delicate object. Push the joystick to the port or starboard, forward or aft and the rig instantaneously follows the fine finger movements on the joystick knob. Twist the knob and the boat spins on its own axis.
2. There are 2 buttons on the joystick. Use the gentler left one for most docking (Max. RPM's 1200). The right boost button is most useful in high wind/current situations (Max. RPM's 2000). This mode shows a marked increase in joystick power.
3. Remember that both engines need to be in neutral before activating the joystick buttons or it will not work.
4. To disengage the joystick press the left joystick button again or engage one of the engine controls into gear.
5. The joystick brain responds to the turns not the position of the wheel. So whatever position you have the wheel facing when you disengage the stern drive joystick that is your new straight ahead position. Most seasoned skippers would position the wheel straight before disengaging the system.
6. You do not have to worry about disengaging the joystick and shifting the control into the drive mode at too high an rpm as the EVC system prevents any shifting above 750 rpm's.



ANCHORING



Your Regal yacht features a stainless steel plow type anchor. The anchor will set quickly in a variety of bottoms because of its unique shank profile and ballasted tip. It is a high holding type anchor made from high

grade manganese steel and stainless steel for maximum tensile strength. The anchor weight is 55 pound or (25) kg. Anchoring is easier with another person on board. First be certain that the line for the anchor is properly attached, to avoid losing the anchor and anchor line overboard.

For more efficiency, a 25' length of galvanized chain has been added to the rode length. The chain will stand up to the abrasion of sand, rock, or mud on the bottom much better than a nylon line. Being galvanized the chain will resist corrosion. Approximately 175' of 3 strand nylon line has been added to ensure a adequate scope in different depths and weather situations. The nylon will stretch under a heavy strain cushioning the impact of waves or wind on both the boat and the anchor.

To anchor, select an area preferably with a flat bottom. Mud, sandy clay and firm sand afford the best bottoms for anchoring. Grassy bottoms often resist the anchor taking hold and end up pulling out grass and roots. Contrary to modern belief, you do not anchor while the boat is making headway, or moving forward. In fact, the bow of the boat should be brought slowly backward, while releasing the anchor until it hits the bottom. To "snub the line" means to stop its outward "pay" or movement.

Usually the length of anchor line used should be 5 to 10 times the depth of the water depending on weather conditions. This ratio is called the "scope"; the minimum scope under average conditions is 7 or 8:1. If the scope is too short the anchor's efficiency is diminished. A longer scope cushions the shock load on the entire system.

Once a scope is determined sometimes it is difficult to know how much line to let out to reach the desired scope especially at night. One way to mark an anchor line that will identify the amount of line is to paint wide and narrow bands from about 50' to 150' in 10' intervals. The wide bands equal 50' and each narrow band would equal 10'. Distinguish each 50' band with a different color paint. This can be done with "see in the dark" paint. Simply tape each length for the appropriate band before painting it.

After you have anchored, check your position with landmarks if possible. You need to continue to monitor these landmarks to make sure you are not drifting. Since anchoring can also be an emergency procedure, the anchor and line should be readily accessible. Check anchor locker to ensure an untangled anchor line.

Once anchored the anchor line must be secured to a strong tie such as a cleat.

Do not rely on the windlass brake to carry the anchor rode load.

Use a series of full turns and half-hitches around the cleat horn to prevent any line slippage or jamming. This is important as the scope may need to be adjusted over a period of time and you need swift access to the line.

For increased holding power in windy conditions, two anchors are sometimes set. If your primary anchor drags, you can run out your secondary anchor without picking up the primary one. The important thing is to lay them out at an angle. When setting two anchors, make sure they are fastened to separate strong ties such as cleats. This is done in case you need to adjust one later so the line must be accessible.

Note: In times of high waves a buoy on the rode works as a shock absorber and allows the vessel's bow to ride the wave crests without large strains being transmitted to the set anchor. These plastic foam buoys can be purchased at boating retail outlets.

Vessel Operation

TOWING

In case you find yourself aground or in need of a tow, or should you want to tow another vessel, keep in mind that you **never use deck hardware or cleats to secure lines for towing!**

Deck hardware is intended for mooring and anchoring, and is not designed to withstand the strain and pull of towing. Rather than tie the line to your cleats on deck, it is suggested that you tie a bridle by passing a line completely around the hull of your boat to avoid structural damage.

When towing, always stand clear of a taut line, as any type of line breaking under stress can be extremely dangerous. The preferred line for towing is double-braided nylon, as it has sufficient elasticity to cushion shock loads. Move slowly and cautiously.

 **DANGER**

AVOID DEATH OR SERIOUS BODILY INJURY!
DO NOT USE DECK HARDWARE
INCLUDING CLEATS FOR TOWING
OR LIFTING PURPOSES.

ADMIRALTY LAW

The Admiralty law sometimes referred to as the salvage law was founded primarily on English law fundamentals and basically says that a vessel distressed, in danger of flounder, if rendered assistance from a towing company or private agency, can be forced to relinquish a portion of the vessels' worth for the assistance received.

NOTICE

IN THE EVENT YOUR VESSEL
IS IN DISTRESS
PRIOR TO ALLOWING
ANY TOWING COMPANY
OR PRIVATE AGENCY THE RIGHT
TO PASS A LINE TO YOUR VESSEL,
BE SURE TO ESTABLISH THAT YOU
DO NOT AGREE TO ANY SALVAGE RIGHTS.
ESTABLISH WITH THE CAPTAIN
OR OPERATOR
THAT YOU WISH TO BE ASSISTED
IN A CONTRACT BASIS
AND ESTABLISH A PRICE.
OF COURSE IN CERTAIN SITUATIONS,
YOU MAY NOT HAVE THIS OPTION.
USE YOUR BEST JUDGEMENT!



EMERGENCIES

Always be ready to help others on the water if possible, but do not take any unnecessary risks. Use equipment to save a life, but do not risk a life to save equipment. Consult earlier information in this manual concerning accidents, etc. Also, read other literature concerning on the water emergencies. Be alert and prepared!

FIRE

Fire aboard a vessel can spread quickly and can cause tremendous alarm among everyone. Most fires can be prevented by keeping the bilge free from oil and debris. Keep all equipment stowed and maintained in working order. Carry backup fire extinguishers on board. If something becomes a possible fire hazard, remove that possibility at once.

Never use water on gasoline, oil or electrical fires. When you dump water on an electrical fire you can be shocked since water conducts electricity.

Follow these instructions if a fire breaks out:

1. Fit everyone aboard with a life jacket. Turn off the ignition switch.
 2. Try to keep the fire downwind. If the fire is to the stern, head the bow toward the wind. If forward, put the stern to the wind.
 3. If the engine should catch fire, shut off the fuel supply. Usually there is a fuel tank access that you can crimp the fuel feed line.
 4. Use a hand fire extinguisher. Make sure to insert it into the fire port location. Release entire contents of portable extinguisher. **Remember: (A 4 pound extinguisher discharges in approximately 20 seconds)**
- These actions help prevent the fire from spreading to other parts of the boat. You can extinguish fires quickly if you act swiftly. Have a plan of action in motion in case a fire breaks out.

FIRST AID

Knowing first aid can save lives. A first aid kit and the ability to use it are important ingredients for the safety of a skipper's passengers, crew and vessel. Having confidence and competence in handling medical emergencies on board is a must for the skipper. Invest your time in a first aid course available at the American Red Cross.

CPR (BASIC LIFE SUPPORT)

If someone is seriously injured have someone call for help while the injured person is being attended.

Check for possible danger signs; loss of breathing, unconsciousness, severe bleeding and heartbeat. If you determine the individual is not breathing or unconscious place the victim on their back on a hard surface and do the following:

1. If unconscious, open the airway. Neck lift, head lift or chin head lift.
2. If not breathing, begin artificial breathing. Pinch the nose. Give 4 quick breaths. If airway is blocked, try back blows, abdominal or chest thrusts and finger probe until airway is open.
3. Check for pulse. Begin artificial circulation. Depress sternum. Fifteen compressions rate 80 per minute. 2 quick breaths. Continue uninterrupted until advanced medical support is available.

HYPOTHERMIA

Hypothermia is a condition where the body temperature decreases because the body can't generate enough heat to maintain its normal temperature. It can be serious and usually occurs where victims have been immersed in water (under 68 degrees) for periods of time. If you encounter a possible hypothermia victim call for help on the radio and get the person out of the water.

Symptoms are:

1. Shivering that if condition is advanced may stop.
2. Confusion, clumsiness or slurred speech.
3. Rigid muscles.
4. Semiconscious to unconscious.

Treat hypothermia by the following:

- Remove wet clothing.
- Monitor the victim's pulse and breathing.
- Rapidly apply heat to the body core by using blankets, naked bodies or warm water.
- Do not give the person any food or drink.
- Do not warm the arms and legs. Warming of these extremities can be fatal.

Follow up immediately with medical authorities!



CALIFORNIA AIR RESOURCE BOARD (CARB) LABEL

Your Regal boat may have a star shaped label affixed to the bow port hull side. It is located at the front of the state registration numbers. This label is part of the California Air Resource Board (Carb) SD/I rule. If your boat is operated in the state of California and/or bordering waters, this label **MUST** remain intact. The label shows that the engine installed as original equipment meets a currently approved California state regulatory emission level. See the example below which shows the current California ultra low 3 star label.



CALIFORNIA PROP 65

Proposition 65 relates to the state of California and is an additional requirement added to their Safe Drinking & Toxic Enforcement Act of 1986. Prop 65 basically summarized states that: “No person in the course of doing business shall knowingly discharge or release a chemical known to the state to cause cancer or reproductive toxicity into water or onto land where such chemical passes or probably will pass into any source of drinking water” and it goes on to say “ no person in the course of doing business shall knowingly and intentionally expose any individual to a chemical known to the state to cause cancer or reproductive toxicity without first giving clear and reasonable warning to such individual”

For more information, contact the California Office of Environmental Health Hazard Assessment at 916-445-6900 or <http://www.oehha.ca.gov/prop65.html>.



WARNING

A wide variety of components used on this vessel contain or emit chemicals known to the State of California to cause cancer and birth defects and other reproductive harm.

EXAMPLES INCLUDE:

- * Engine and generator exhaust
- * Engine and generator fuel, and other liquids such as coolants and oil, especially used motor oil
- * Cooking fuels
- * Cleaners, paints, substances used for vessel repair
- * Waste materials that result from wear of vessel components
- * Lead from battery terminals and from other sources such as ballast or fishing sinkers

TO AVOID HARM:

- * Keep away from engine, generator, and cooking fuel exhaust fumes
- * Wash areas thoroughly with soap & water after handling the substances above

For further information, refer to page 2 of this manual.

Vessel Operation

FUEL SPILLAGE

The federal water pollution control act prohibits the discharge of oil or oil waste (such as from the sump bilge pump) into or upon the navigable waters of the United States or the waters of the contiguous zone. Violators are subject to substantial civil fines and criminal sanctions.

A placard is normally found inside the engine hatch area or in the sump warning of overboard discharge of oil or oily waste.

ENVIRONMENTAL AWARENESS

There are numerous vessels operating on our waterways on a daily basis. Each boat has an impact on our environment. Boat operation habits, marine sanitation, and maintenance all play a role in a delicate battle to keep the ecosystem clean. Each of us has a role in doing our part as an environmentally conscious skipper to conserve our waterways.

The National Marine Manufacturer's Association lists their top ten of Eco-Boating Practices as follows:

1. Observe all regulatory agency policies regarding marine toilets.
2. If equipped with a holding tank, use marina pump-out facilities.
3. If used, make sure bottom paints are legal and ecosystem friendly.
4. Use only biodegradable cleaning agents.
5. Dispose of all garbage and litter on shore properly, not on the water.
6. Don't top off fuel tanks. Leave expansion room. Clean up spills.
7. Watch your wake and propeller wash.
8. Make sure your engines are well tuned and maintained.
9. Control your bilge water.
10. When fishing, practice the "catch and release" principle.



TRAILERING

This chapter covers trailering/towing basics including equipment, maintenance, and techniques of using a trailer. *Check with state and local agencies for detailed information on required equipment, safety issues, and licensing.*

BEFORE TOWING

Before towing your boat, be sure to check the air pressure of your tires for the recommended inflation rating. Also, be certain that your tow vehicle is in good working order. *Install bimini top in its boot before towing. Also, remove and store cockpit and bow cover. Store cockpit carpet along with cockpit/mooring/bow covers in ski locker.*

This can make it especially difficult to drive safely, as the hitch may be in danger of striking the road. Also, this situation can be caused by worn vehicle rear shock absorbers. One option is to install a set of air shocks which will assist in supporting the load. As a rule of thumb 5 to 7 percent of the total trailer load should be on the trailer tongue.

Check all lights to ensure they all work properly. You may find it helpful to ask someone to check your turn signals, brake lights, and towing lights while you remain in the vehicle. Be certain that the trailer winch cable is securely attached to the boat's bow eye and the cable lock is engaged. Make sure the bow of the boat is snug against the bow stop at the winch stand.

It is a good idea to tie another line or secure an extra cable to the winch stand and boat bow eye as a backup system. Be certain that your trailer is of rated capacity for the size and weight of your boat, including the weight for all fuel, water and gear.

Your authorized Regal dealer can advise you on the proper trailer capacity and tongue weight (the weight exerted on the rear of your vehicle).

service and maintenance instructions. Never use a bumper mounted trailer hitch. Always use a bolted or welded frame-mounted hitch, class 2 or 3. Consult your Regal dealer for more information.

Should your trailer be equipped with surge brakes, that is brakes on the trailer that cut in with a very slight delay when your brakes are applied, be sure to follow recommended instructions. Be sure that the trailer master cylinder is filled with the recommended fluid before towing your boat. Inspect the trailer brake lines for any leakage. Also, if you notice brake fluid on the inside of the tires, you may have a wheel cylinder leaking. Consult a professional. Never place your hands between the trailer hitch coupling and the hitch ball on your towing vehicle while hooking up. Be sure the tongue jack is in the full up position before departure. Be certain safety chains are crisscrossed and secured; do not allow them to drag on the road. Be sure to buy a suitable set of tie downs which can be attached to the boats' stern eyes and the eyelets provided on most trailers. Tighten them securely and neatly fold up the extra strap material and secure it with tape so it doesn't loosen and dangle on the road.

Be sure to buy a suitable set of tie downs which can be attached to the boats' stern eyes and the eyelets provided on most trailers. Tighten them securely and neatly fold up the extra strap material and secure it with tape so it doesn't loosen and dangle on the road.

Vessel Operation

Check the trailer harness often for signs of fraying. Check the harness connector for corrosion. Make sure the trailer harness when connected to the trailer has enough slack for turning

Check the wheel bearings for wear periodically by a professional. On most trailers, there is a zerk fitting on the wheel hub to add the proper lubricant to the wheel bearing with a grease gun. These wheel bearing waterproof covers for the bearings can be purchased at retail outlets. Check the trailer lug nuts for the proper torque. Use a foot pound wrench and torque in a star sequence to the correct poundage as recommended by the trailer manufacturer. Torque the lug nuts at half the poundage on all nuts. Then set the torque wrench to the full poundage and fasten to the last foot poundage figure.

Check the trailer tires often for voids, excessive wear or out of round tire conditions. If the trailer seems to vibrate you may have a bad tire or one that is unbalanced. These wheels can be rebalanced at most automotive or tire shops. Never pull a boat on a patched tire. Buy a spare tire and wheel including a hub and wheel bearing assembly. Mount it on the trailer for speedy installation should a blow out occur. Be sure everything is secured in the boat and canvas is down in the towing position with the bimini stored in the boot. Tilt the stern drive up to clear the road and any bumps that might occur while in transit.

DRIVING

Practice maneuvering the vehicle and trailer in a large, empty parking lot or open space. If you practice slowly and cautiously, you will soon develop a feel for maneuvering the trailer .

Test your vehicle and trailer brakes before departure along with the lights. Pack a tool kit with extra bulbs, fuses and fluids.

Drive as smoothly as possible, anticipating your stops and giving yourself plenty of room for turning and stopping. Avoid any quick turns or sudden jerks of the steering wheel.

Remember to maintain safe speed limits. It takes longer to stop your loaded boat. Allow enough room to the front in bad weather.

Keep an eye on your rig through the rear view and side mirrors. If your rear view mirror is obstructed, purchase a set of side mirrors that extend out over the side of the vehicle for increased visibility. In addition, it is a good idea to install a set of round mirrors to the side mirrors as they help identify blind spots.

Plan to stop periodically on your way to check the trailer hitch for tightness, harness connector, tires and wheel bearings. Also, check to make sure the load is balanced.



LAUNCHING

Serious accidents can occur at the launching ramp. Therefore, it is imperative you be alert and attentive during launching and docking activities. Study the ramp area and surrounding water for any potential hazards, such as a short ramp or one with a drop off at the end. If you are uncertain of the conditions, ask someone else who has just used the ramp if there are any peculiarities to the area. Install the drain plug. Attach 2 lines, one each at the bow and stern, to control your boat once it is off the trailer. If you need additional fenders to keep the sides of the boat from banging against the ramp walls, use those as well. Unhook the stern tie-downs and the winch line to the bow. Unplug the trailer harness connector so the hot trailer light bulbs won't blow out when they come in contact with water.

When backing in, have someone assist, giving the palms up stop signal when the boat is in deep enough water to float off, or when the rear wheels of your vehicle approach the water's edge.

After your boat is floating freely, position it clear of the trailer before pulling out of the water. If there is no one to help you, secure one of the lines you've attached from the boat to the dock and use the other line to pull the boat off trailer. The process is easier with 2 people.

Ramps are very slippery. Do not attempt to walk or stand on an angled boat ramp.



CAUTION

AVOID LOSING VEHICLE TRACTION!
DO NOT ALLOW REAR WHEELS TO
ENCOUNTER SAND OR SLIPPERY
CONCRETE CONDITIONS.



WARNING

AVOID BODILY INJURY!
DO NOT ATTEMPT TO WALK OR STAND
ON AN ANGLED BOAT RAMP.

TRAILER TERMINOLOGY

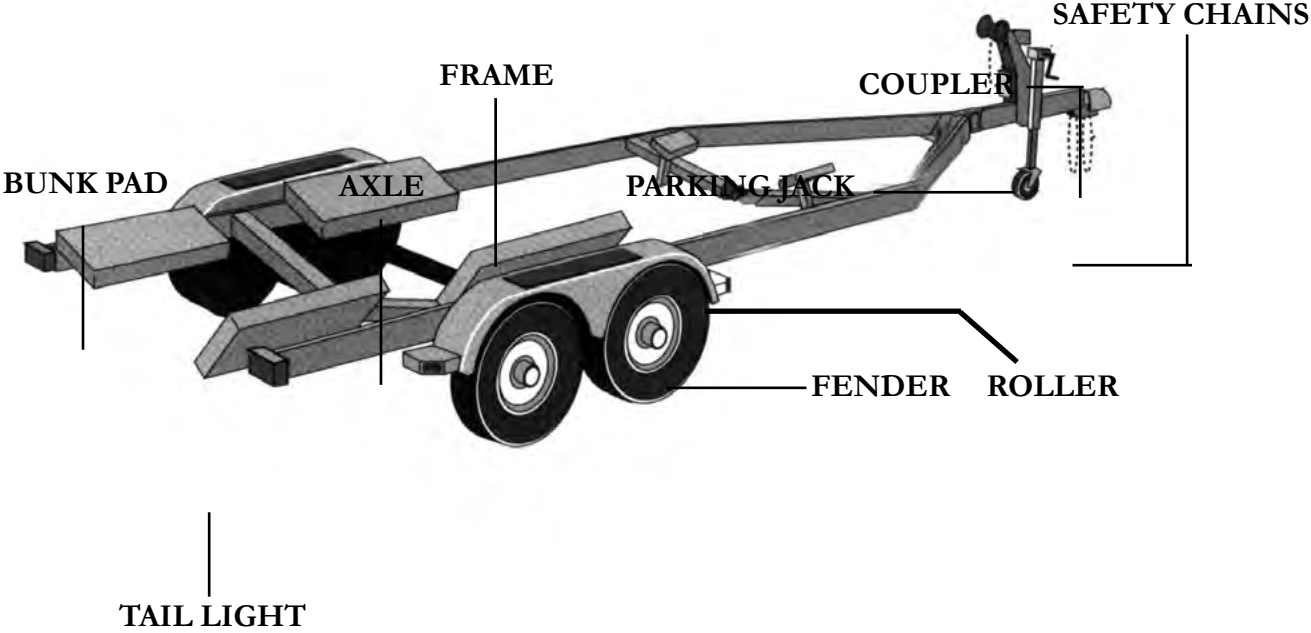

TYPICAL TRAILER SHOWN

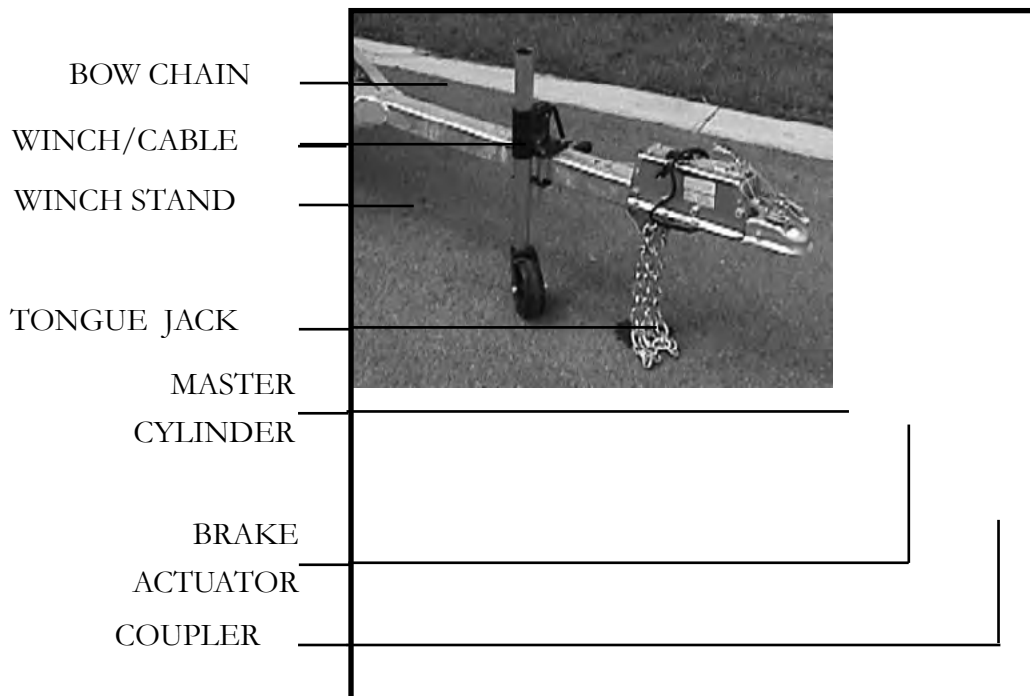
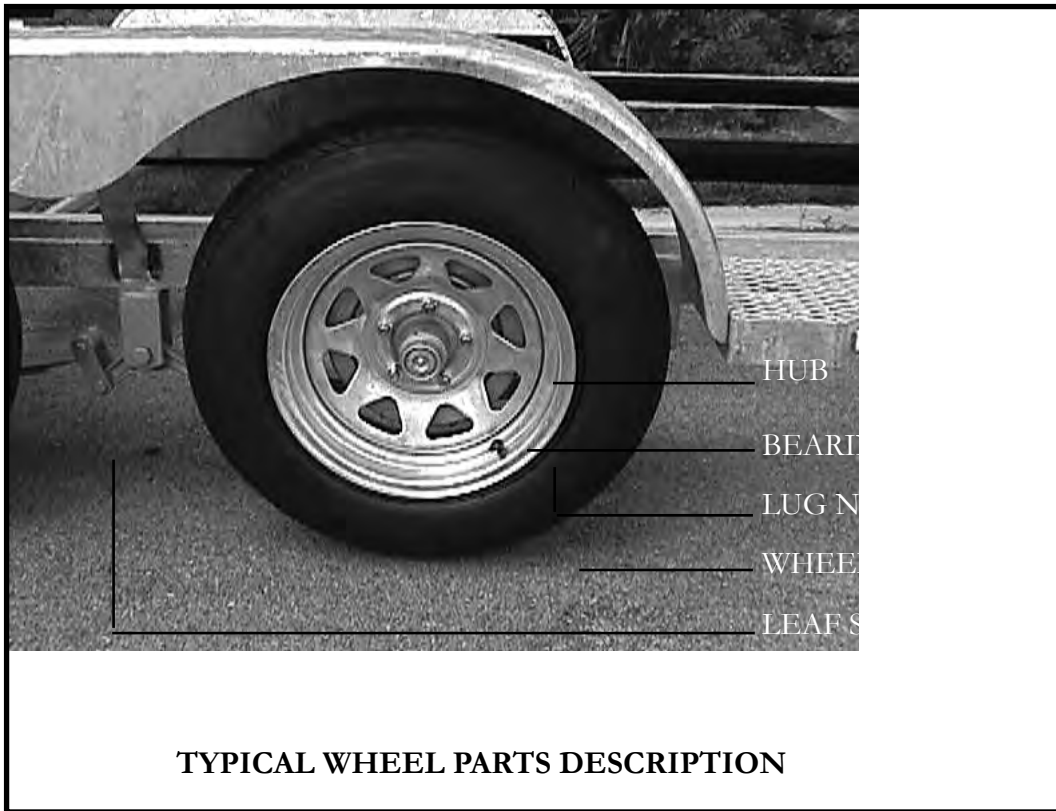

SPARE PARTS CHECKLIST

Longer towing trips increase the need for special preparations. Sometimes these extended trips cover areas where it is difficult in locating repair parts due to a breakdown. Following is a checklist of recommended items to add a safety net to your trip.

Trailer-

1. Trailer tire jack
2. Spare hub assembly including wheel bearings
3. Spare tire
4. Lug wrench
5. Jack stand
6. 12 volt air compressor- found at automotive box stores
7. Spare bearing protector
8. Extra tie-down straps
9. Trailer light bulbs
10. Brake pads and brake fluid
11. Grease gun

Tow Vehicle-

1. Tool kit including necessary ratchet and sockets
2. Jumper cables
3. Extra fuses
4. Engine oil
5. Transmission fluid
6. Wheel chocks
7. Highway flares
8. 12 volt spotlight- type that plugs into 12 volt accessory outlet
9. Flashlight & spare batteries
10. Waterless hand cleaner and rags
11. Electrical connectors and crimpers
12. Low voltage electrical tester



BACKING A TRAILER

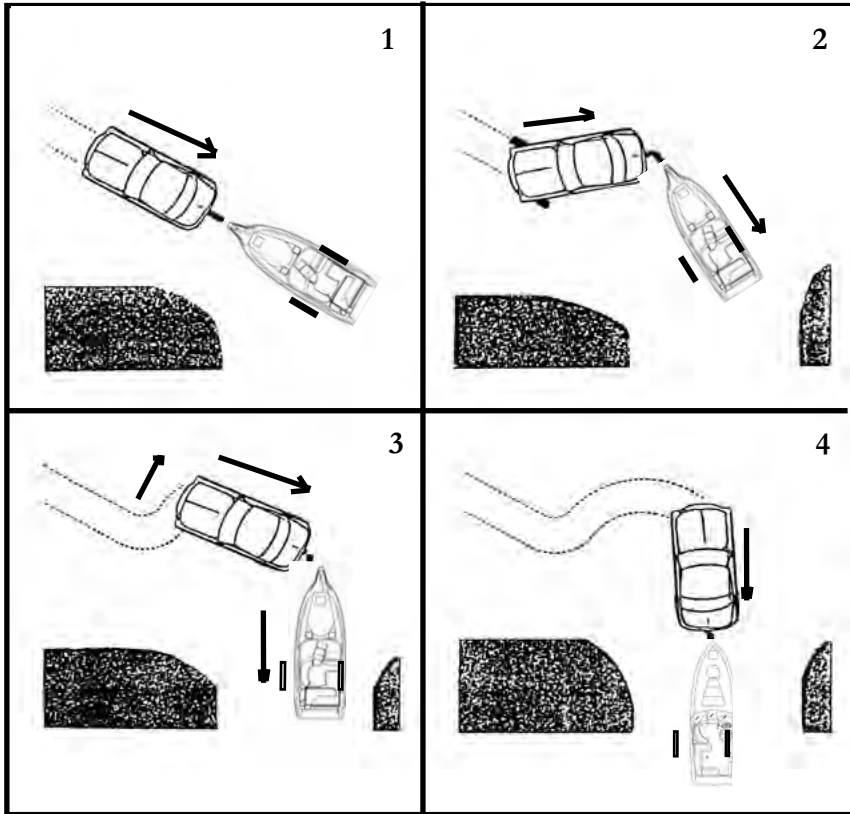

A trailer backs in a direction opposite to an automobile. In 1, driver swings the rig near the launching ramp. In 2, the driver cuts the vehicle toward the driveway. In 3, the driver cuts the vehicle wheels to the left and then backs into the ramp as the trailer moves to the right. In 4, the driver straightens the vehicle wheels to follow the trailer as it backs down the ramp.

Vessel Operation

LOADING



The most important thing to remember when pulling your boat out the water is often the ramp will be crowded. As you approach the

you ramp, make a visual inspection of the traffic and people, both at the ramp and all around you. This is an important time to use caution, courtesy, and common sense. While you may feel it's your next turn, another boater may not be as courteous. Don't insist on your rightful place in line; it could lead to disastrous consequences in the confines of a crowded boat ramp. If there is any perceived danger, stand off until you can safely approach the ramp. Back your trailer down to the water's edge. At this point it is a good idea to let a sufficient amount of line out of the winch to reach the bow eye. Make sure you disconnect the trailer harness to keep the bulbs from blowing out due them being subjected to the cold water.

On roller or bunk style trailers back up until the aft roller is just at the water level. This allows you to hook up the winch cable and to start cranking the boat on to the trailer properly. This method gives you a good starting point and helps keep the boat centered on the trailer as it is reloaded. It may be necessary to further back the trailer into the water. This permits cranking the boat easier on to the trailer.

Once the boat is positioned correctly on the trailer have someone hook up the winch cable hook to the bow eye. Also, this will help keep the boat bow against the trailer roller. Shut down the engine and run the stern drive up to the top of the trailer position.

With the bow snug against the roller, start to crank the boat up on to the trailer. Make sure the hull bottom or keel stays in the center of each roller as it is being cranked on the trailer. **Double check** to ensure the hitch is locked tight on the vehicle ball. Make sure the boat is covered properly and all loose gear is stowed.

On bunk style trailers, watch the bunks to make sure the boat is centered as they usually do not touch any rollers other than the aft one because the boat weight is being supported more by the bunks as it is cranked onto the trailer. Stop cranking the winch when the boat bow contacts the bow roller. Be sure the winch is in the locked position. Stand back and visually check to see that the boat is centered on the trailer.

After pulling your boat away from the ramp, be sure to go through all the checks involved before departure. Reinstall the harness connector and check the lights, brakes, safety chain, winch, hitch, and tie downs. Remove the drain plug to exit any excess water in the bilge. Reinstall the hull drain plug and tighten it. For longer storage periods remove the drain plug and keep in a plastic bag tied to the steering wheel.



WARNING

AVOID BODILY INJURY!
DO NOT LET ANYONE STAND NEAR THE
CABLE. IT COULD BREAK!



CAUTION

HULL BOTTOM DAMAGE COULD
RESULT FROM THE BOAT NOT BEING
POSITIONED ON THE ROLLERS BUT
RESTING ON THE TRAILER FRAME.
AVOID BACKING TRAILER
TO FAR BACK IN THE WATER.

Auxiliary Equipment Operation

AUXILIARY COMPONENTS



OVERVIEW

In addition to the main components and systems reviewed in Chapter 4 there are other auxiliary equipment components outlined here. To locate more detailed information for the auxiliary components refer to the appropriate manufacturers owner's manual found in the owner's information packet. Also, further updated information may be available on the internet by using the proper name of the component and the Goggle® search vehicle.

Note: Equipment or vendors may change during a boat's life cycle as we are constantly upgrading our product line. Regal Marine Industries, Inc. retains the right to change vendors, equipment, specifications, component location, and other technical data at any time.



INTERIOR EQUIPMENT

CARBON MONOXIDE DETECTORS

Carbon monoxide known as CO is indeed the silent killer. It is a by-product of combustion. CO is invisible, tasteless, odorless and is produced by all internal combustion engines, heating and cooking appliances.

The most common forms of CO on board vessels are petrol engines/generators and if applicable, propane heating and cooking devices. *Note: Even though your vessels propulsion system is diesel based follow the CO precautions. Also, remember that a vessel moored next to you may be a CO poison contributor.*

Never operate these devices when people are sleeping. A slight amount of CO in the human body over several hours causes headaches, nausea and symptoms close to food poisoning, motion sickness or flu. High concentrations can be fatal within minutes.

HOW THE SYSTEM WORKS

The CO detector uses a mini computer to measure and accumulate CO levels. Using the principle of “time weighted averaging” the detector monitors CO concentrations, temperature, humidity and time to calculate COHb levels. To explain COHb, our bodies prefer to absorb CO to oxygen and COHb is the absorbed ratio stated in a percent.

If the detector senses high levels of CO the alarm will sound in a few minutes. If lower levels are sensed, the detector will accumulate the data and sound an alarm when the appropriate level is reached. *Read and understand the CO owner's manual in the information pouch.*

To turn the CO detector system on:

1. There is a breaker switch located at the main DC panel. The CO circuitry works to its best performance when continually activated plus it accords advanced warning when entering an area high in CO.

2. When power is applied to the detector, the power indicator (top) will flash on and off, followed by the (red) lower alarm indicator flashing off and on as part of a 8-14 minute warm-up period. The green (top) power indicator will indicate a solid green when the unit has reached correct operating temperature. Never operate a cooking device with the canvas up or the cabin door completely closed to prevent CO concentration build-up

CO DETECTOR



3. The test cycle should be activated frequently. Simply press the button. When it is released, the (top) power indicator will flash off and the lower indicator light will flash on. Then, the lower indicator will flash off and the upper indicator light will come back on. The top indicator light being on solid green indicates *normal* operation.

Refer to the CO detectors owner's manual for an explanation of the test cycle indicators.

4. When an alarm sounds take action immediately. The danger alarm indicator flashes red and the horn beeps 4 times, pauses and repeats the cycle. This indicates a rate of 10% COHb has been reached.

- Operate reset/silence button.
- Call your emergency services (911)
- Immediately move to fresh air. Do not re-enter the vessel until emergency personnel have arrived, aired the vessel out and the alarm is in a normal condition.
- After following steps a-c and your alarm reactivates within a 24-hour period call a qualified technician to inspect the vessel. Note that the CO detector will clear when the CO concentration has dropped below 70 parts per minute.

Auxiliary Equipment Operation

DOOR-COMPANIONWAY-TYPICAL



Keep the cabin door closed when the boat is moving. When at mooring, the cabin entry door can be held open by sliding the door and securing it open with the door stop. This will prohibit the door from accidentally closing. Periodically, remove any accumulated door track debris and lubricate the tracks lightly with silicone lube to keep the door

sliding freely.

GRAY WATER SYSTEM

If installed, the gray water system equipment collects all used water exiting from the shower sump pumps along with the galley and head sinks. The used water is stored in the ship's holding (waste) tank. This option is used in various locals where it is illegal to pump "gray" shower and sink water overboard. The automatic float switch pumps gray water to the holding tank.

Normally it would not require any special service unless there was blockage somewhere in the system or a hose leak developed in the system. Since more liquid in the form of gray water is being returned to the holding tank pay closer attention to the waste monitor panel. The holding (waste) tank may need to be pumped out more frequently.

FWD. BERTH-SLEEPER CONVERSION



The salon seating converts to a sleeper by filling in the cushions. Note that the fill in cushions use a clip system to retain the cushions in the stored position. When making

up the sleeper fill in the front, mid, and aft cushions in that order.



HATCH-TYPICAL

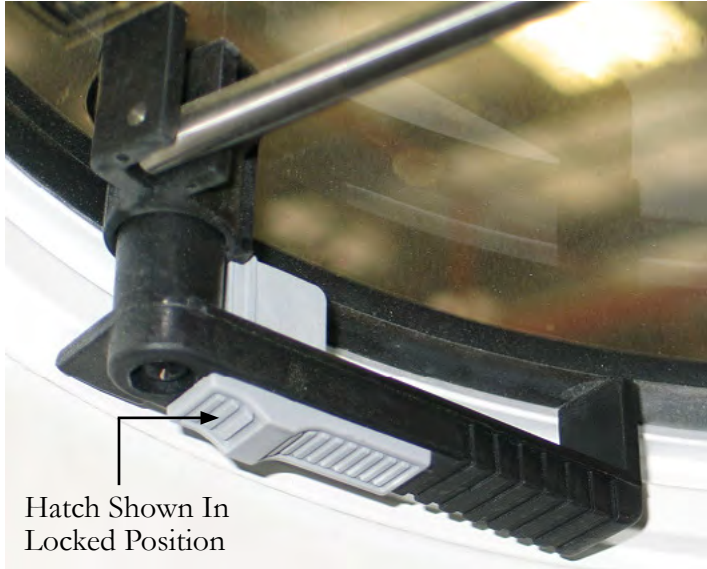

Select deck hatches feature dual lockable positions. To lock the hatch first grab the handle and turn it so it engages the side of the seal ring as shown. Push the lock mechanism to engage the handle in the locked position.

To unlock the hatch pull the handle away from the seal ring (in line with adjuster) or 90 degrees from the locked position.

To open the hatch make sure the hatch is unlocked. Then push the rod up and lock at desired angle by turning the adjuster.

A screen is provided for cross ventilation and to protect against insects. Secure the screen by turning the tabs at a 90 degree angle to the screen framework.

Note: While underway close and lock all hatches securely.

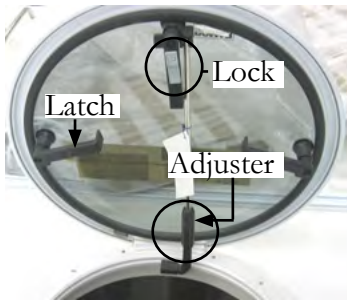

Auxiliary Equipment Operation

LIGHTING-GENERAL

Your vessel features various styles of lighting such as overhead, hanging locker, reading and florescent types. Each lighting fixture requires specific bulb types and replacement procedures. Read and understand the following warning.

 **WARNING**

**AVOID SERIOUS INJURY!
EARLIER HALOGEN & XENON LIGHT BULBS
DEVELOP EXTREMELY HOT
TEMPERATURES.
NEVER REMOVE A HOT LIGHT BULB SINCE
IT COULD CAUSE SKIN BURNS.
WAIT FOR THE BULB TO COOL
BEFORE ATTEMPTING TO REMOVE IT.**

Note: The bulbs listed in the following pages can be ordered through a Regal dealer or may be available at speciality lighting or box stores. When changing the earlier halogen light bulbs never touch the bulb surface with your fingers as premature burn out can occur due to oil on the skin touching the bulb surface. Handle bulbs only from the ends.

To change the earlier halogen overhead light bulb follow these steps:

Using a sharp object such as a small slotted screwdriver, slide it between the lens cover and the light base.

Pull down on the lens cover to access the bulb.

Remove the defective bulb.

Replace the bulb with a 12 volt, #10WXM halogen type.

Line up the space in the lens cover/body with the notched area of the light base.

Push the prongs on the lens cover/body upward until they seat into the light base.



Later overhead lights use LED technology which is known for clear visibility, long service life, and energy savings.

Note: *These later LED lights will feel much cooler than the previous halogen type.*



HANGING LOCKER LIGHTS-TYPICAL

READING LIGHTS-TYPICAL



Lens Cover Removed

The reading lights use a marine type bulb that allows for rough service. To change the bulb turn the fixture and grasp the old bulb and pull it straight out. Replace with the same wattage bulb. Reinstall the bulb in the lamp socket using a tissue to hold it. This procedure will help extend the bulb service life.

To change a hanging locker light bulb follow these steps:

- Remove the lens cover from the lamp base. There is a tab on the bottom of the lens cover. Push the lens cover at this point to remove it.
- Remove the defective bulb.
- Replace the bulb with a 12 volt halogen bulb type # 563.
- Reinstall the lens cover by snapping it in place.

Auxiliary Equipment Operation

MONITOR-WATER/WASTE



Notice the key switch portion of the monitor. The key switch controls an overboard discharge pump (macerator) which grinds up the waste and sends it through the hull bottom. Make sure the waste seacock is open and you are legal to pump overboard. Turn the macerator breaker on and then energize the monitor panel key switch by turning it to the “on” position and holding it while you press the red button to activate the pump.

Be sure to turn the seacock off and secure it with a tie wrap after the pump-out cycle is completed as you can be fined if authorities find the seacock in an unlocked position.

To read either the fresh water or waste water monitor panel the breaker on the main DC panel must be activated.

The optional monitor is normally located inside the ship’s AC/DC cabinet or may be located behind the starboard picture window on a trim panel.

The fresh water monitor displays the amount of potable water in the system. There are sensors located in the water tank that send a signal to the display panel when activated. Press the top portion of the toggle switch and read the gauge display.

The waste portion of the display shows the amount of waste water in the holding tank. There are sensors located in the waste tank that send a signal to the display panel when activated. Press the bottom portion of the toggle switch and read the gauge display.

This portion of the system needs to be monitored periodically to prevent the system from being over full which could cause equipment damage and/or a possible leak in the vessel.

If the waste system is determined to be full it can be emptied by connecting a marina pump-out hose to the waste fitting located on the deck. The pump out device will actually remove the waste much like a vacuum cleaner. This is the easiest way to eliminate the vessel’s waste and be environmentally friendly while performing the task.

An alternative method *which can be used in International waters only* is to pump the waste overboard using the waste seacock.



PORT/STARBOARD HULL WINDOWS

Port and starboard windows provide natural cabin lighting. The windows are tinted, tempered safety glass components. They are trimmed with curtains. Windows are installed with an adhesive that is flexible and still provides an encapsulated product with waterproof protection. Do not use ammonia products on the windows. Other less chemically harsh cleaning products are available.

TYPICAL ALCOHOL STOVE

Standard equipment is an alcohol stove. In theory, alcohol is used as a fuel. There is a tank that is filled. The top is closed and it is pumped up. At that point a valve is opened for each burner and a small amount of alcohol is released. After closing each burner valve the burner is lighted and it begins to produce heat. Then the burner knob is opened and it is fully lighted and the knob is used for burner temperature control. Read the stove manual for fuel recommendations, safety and operating instructions before attempting to operate the stove.

Auxiliary Equipment Operation

OPT. ELECTRIC STOVE-TYPICAL



WARNING

AVOID SERIOUS INJURY!
NEVER ALLOW SMALL CHILDREN
NEAR THE COOK TOP!



WARNING

AVOID SERIOUS INJURY!
OBSERVE ALL SAFETY INSTRUCTIONS
WHILE USING THE COOK TOP.

With the 30 amp electrical package option an electric stove is provided. There is a stove breaker on the main AC panel. Energize the breaker for the stove to operate. Always have the correct type portable fire extinguisher ready when cooking aboard the vessel. Read the stove operator's manual before using the stove.

Refer to the stove operation manual in your owner's information packet for more information especially on safety measures while operating the stove.

Note that without the 30 amp power package an alcohol electric single burner stove is provided and obviously the stove only works on the alcohol side.



REFRIGERATOR-TYPICAL

OVERVIEW

If installed your galley refrigerator is designed to operate in the tough marine environment. It can withstand a heel angle up to 30 degrees for a short time which makes it very adaptable for marine use. A few tips on the refrigerator:

1. The refrigerator uses AC/DC current switching automatically as needed as it is dual voltage.. Turn on the breaker at the ship's AC/DC service panel before activating the refrigerator.
2. Unnecessary opening of the refrigerator door will increase power consumption.
3. Keep the inside of the unit clean and dry.
4. Remove any water that may collect on the shelf under the freezer compartment.
5. When leaving the vessel for extended periods of time turn the breaker off at the ship's service panel. Remove any food from the unit. Prop the door open slightly before leaving the vessel. This helps air out the refrigerator.
6. Note: The unit will keep food cold 5-6 hours without any DC power providing the food is chilled already.
7. It is important that the refrigerator compressor/condenser be well ventilated so cooler air can enter from the bottom and warm air can exit the top of the unit. Never block any of the ventilation grilles.

Auxiliary Equipment Operation

TEMPERATURE SETTING-TYPICAL

If installed your refrigerator is equipped with a manually controlled infinitely-variable thermostat.

Turn the thermostat clockwise to lower the temperature and counterclockwise to raise the temperature and to activate the on-off switch. A slight spring resistance is noticeable at the on-off switch.

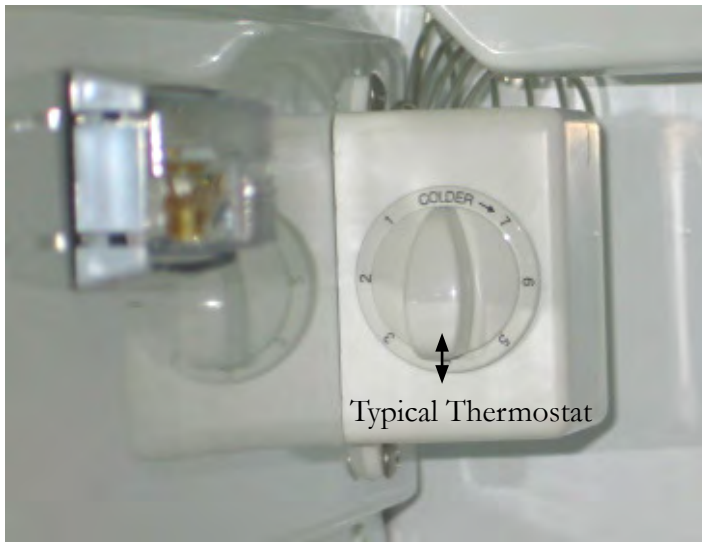

DEFROSTING

The refrigerator requires defrosting when the frost layer is around 1/8”.

To defrost do the following:

1. Turn the thermostat off.
2. Store the food and beverages from the refrigerator in an iced down cooler.
3. Do not use sharp metal objects to remove the accumulated ice. Let the refrigerator deice under normal cabin temperatures.
4. Restart the refrigerator after it is completely defrosted. Be sure to clean and dry the unit.
5. Empty the drip tray below the freezer compartment as often as needed in the defrosting cycle.

Normal Refrigerator Operating Sounds

Your refrigerator/ice-maker combo features rigid foam insulated cabinets to provide high thermal efficiency and maximum sound reduction for its internal working components. In spite of this, the unit still may make some unfamiliar sounds.

Normal operating sounds may be more noticeable because of the unit's environment. Hard surfaces such as fiberglass floors have a tendency to reflect normal appliance operating noises.

Common refrigeration components, and a brief description of the normal operating sounds they make, are listed below.

Note: Your unit may not contain all of the components listed.

Compressor- The compressor makes a humming or pulsing sound during normal operation.

Evaporator- Refrigerant flowing through this unit may sound like boiling water.

Condenser Fan- May hear air moving through it.

Water Valve- At each cycle, a buzzing is heard.



Periods Of Non-Use

During extended periods of non-use take the following precautions.

1. Turn off the ice-maker breaker at the ship's AC distribution panel.
2. Turn the unit to the "OFF" position at the power valve.
3. Raise the bin arm to turn the ice-maker off.
4. Empty the refrigerator of all items. Clean the interior of the unit with a mild non-abrasive detergent and warm water solution applied with a soft sponge or soft cloth. Rinse with warm water and a soft sponge. For rust spots use Bon-Ami ® or Barkeepers Friend Cleanser®
5. Prop the door open. The unit will manually defrost.

Auxiliary Equipment Operation

SALON TABLE-TYPICAL



SALON-DINETTE TABLE SET-UP

The salon dinette table is located to provide easy access for dining needs. To use the table:

1. Locate the table in the salon or the cockpit.
2. For ease of installation set the table on the sofa with the table support facing up.
3. Locate the table leg. Normally it is stored in the center floor hatch opposite the salon sofa.
4. Install the table leg in the angled table receiver on the sofa riser surface or in the metal floor receiver. Pull the spring latch pin and hold until the leg bottoms out. Release the pin to lock the table leg.
5. Install the table onto the top table support until it bottoms out. Flip the hinges back to provide larger dining surface.

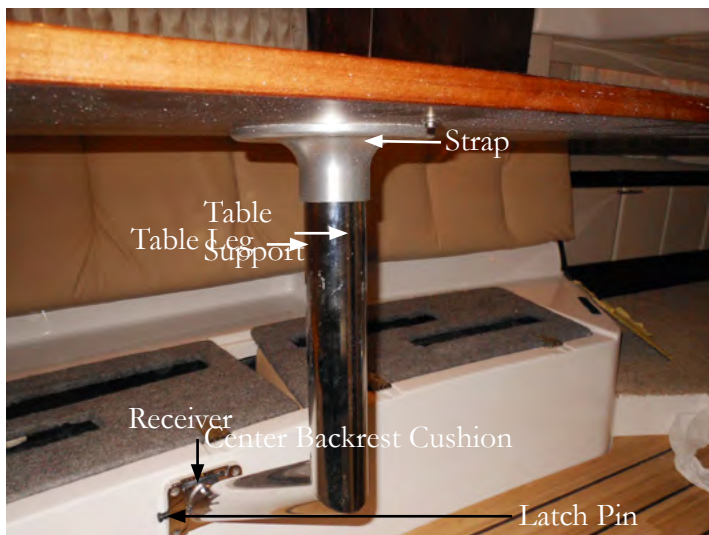

Note that table size, shape and appearance may vary from the photos on this page.



SEAT-HELM (TYPICAL)



Flip Front Cushion Up For Increased Standing Room

The helm seat features a leaning post to gain extra height or additional standing room at the helm when maneuvering in close quarters.

To add seat height using the leaning bolster lift the front of the helm seat upward. This permits the leaning bolster to rotate upward until fully extended. See the illustration.

Auxiliary Equipment Operation

EXTERIOR EQUIPMENT

ANTENNAE

The GPS/plotter antenna includes a built-in position fixing receiver. The GPS plotter features a filter that compensates for the rolling motion of your boat for clearer course and speed information. The antenna is protected by the plotter breakers.

The antenna receiver is located under the forward deck rope locker. Plexius is used as the attaching compound.



The electronics installed on your boat are NEMA 2000 compatible which permits system components to share information with other marine-network compatible devices. Refer to your GPS/plotter owner's manual for further information.

Be aware of the vessel's bridge clearance specifications to avoid equipment/vessel damage due to impacting a bridge structure since a great portion of the antenna/receiving equipment is mounted on the hard top. Remember that the masthead light on the hardtop can be lowered if needed. The VHF radio uses a whip style fiberglass antenna which is "trimmed" to provide the best output and reception. The TV antenna mounted on the hard top is shaped like a saucer.

For further information on antennas refer to each vendor's owners manual.



BILGE PUMP/FLOAT SWITCH

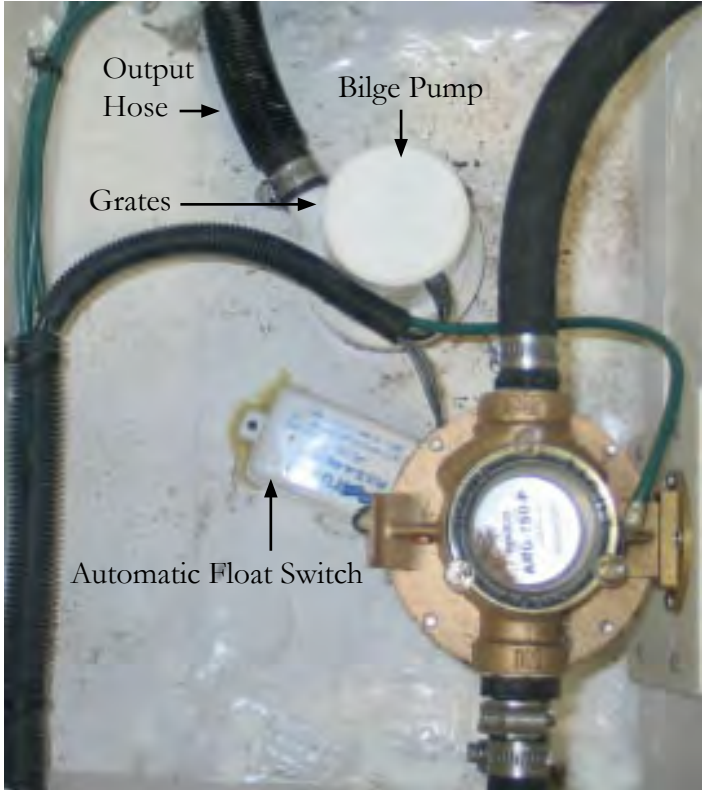

Your Regal boat features a bilge pump and float switch located in the sump (bilge). They are operated through a helm switch.

In the “off” position the switch is connected into the automatic float switch. In this “auto” position if the boat takes on water, the bilge pump will activate and pump excess water overboard. The switch will light up when activated. Periodically check the grates for debris and spray the units down with water. Make sure a steady stream of water exits the through hull fitting indicating the entire output hose system from the bilge pump itself is debris free.

Monitor your helm bilge pump switch light periodically during your cruise. If a light is on that means that the bilge pump circuit is energied. Stop the vessel and find the cause of the problem.

Auxiliary Equipment Operation

DOOR-TRANSOM-TYPICAL



To open the transom door (gate style) pull up on the framework until the door hinge releases and swivels to an open detent position.

To close the door pull up on the framework until the door hinge releases and swivels to a closed detent position. Push down to lock.



WARNING

PREVENT SERIOUS INJURY OR DEATH
FROM FALLING OVERBOARD!
KEEP THE TRANSOM GATE (DOOR)
IN THE LOCKED POSITION
AT ALL TIMES.



FIRE EXTINGUISHER- AUTOMATIC

OPERATION-AUTOMATIC



Fireboy systems are not nor are they intended to be explosion suppression devices. **Boat owner's still need to take normal precautions for checking fumes and using the blower.**

Read the information in chapter 4 regarding the dash installed portion of the fire extinguisher system. When the system actuation starts you may hear a loud sound similar to that of small arms fire, followed by a rushing air sound. The system will show actuation whenever the ignition key is ON and the indicator light is OFF. The actual actuation time when a fire occurs is dependent on the severity of the fire.

When the automatic fire extinguisher activates **IMMEDIATELY SHUT DOWN ALL ENGINES, POWERED VENTILATION (BLOWER), ELECTRICAL SYSTEMS AND EXTINGUISH ALL SMOKING MATERIALS. DO NOT OPEN THE ENGINE COMPARTMENT IMMEDIATELY!**

Allow the agent to “soak” the compartment for a period of time and wait for hot metals and any fuels to cool before inspecting for the fire cause. Premature opening of the engine compartment allows an in-rushing of oxygen and could result in a flash-back. When the engine compartment is opened have approved portable fire extinguishers ready to use.

OVERVIEW

The optional Fire-boy automatic fire extinguishing system is located in the bilge at the forward engine bulkhead. See the illustration. The system uses a environmentally friendly agent FE-241 which has been approved by the EPA to replace the old Halon agent. This system is formulated only for use in the engine space or bilge of your vessel. FE-241 is to be used with gasoline fuel systems only since the agent will not “stall” diesel engines. This could cause a fire to re-flash.

OPERATION-MANUAL

If a fire has started in the engine compartment where the Fireboy is located, **DO NOT WAIT FOR AUTOMATIC ACTIVATION. Release the system manually.** Close any opened hatches leading to the engine compartment, shut down all forced ventilation devices, engines, generators and electrical components. **Remove the safety pin from the “Fire” T-handle, and pull T-handle firmly and release. A loud “rushing” or air” sound will be heard.** Complete discharge will take several seconds. **DO NOT OPEN THE COMPARTMENT IMMEDIATELY!** Keep the compartment closed for a period of time sufficient to allow the agent to soak all areas of the protected space. This allows hot metals to cool.

Auxiliary Equipment Operation

Premature opening of the compartment could cause a re-flash. When opening the engine compartment for inspection have hand held portable extinguishers ready. Inspect the pressure gauge and system before and after each outing. Refer to the maintenance chapter for caring for your fire extinguisher system. The illustration opposite shows the actuator not discharged at the top and one which has been discharged at the bottom. Manual pull is located starboard of the helm seat.

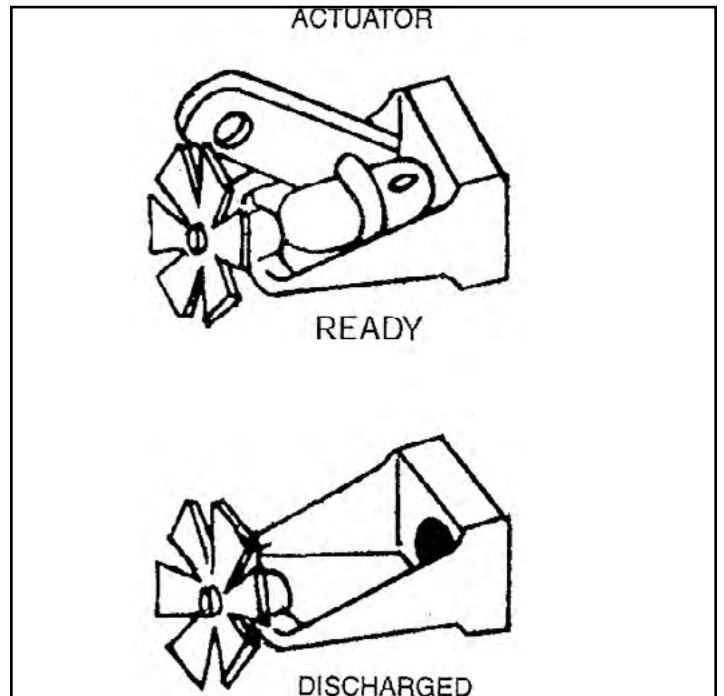

Typical Portable Fire Extinguisher



Portable fire extinguishers may be found in various cabin and cockpit lockers. On select vessels a label may be present on the exterior cabinet doors identifying portable fire extinguisher locations. Know the location of portable fire extinguishers and perform periodic inspections.

! WARNING

AVOID SERIOUS INJURY OR DEATH!
DO NOT BREATH FUMES OR VAPORS
CAUSED BY A FIRE AS THEY ARE
HAZARDOUS AND TOXIC.

! WARNING

AVOID SERIOUS INJURY OR DEATH!
ACCIDENTAL DISCHARGE COULD OCCUR
DURING HANDLING, INSPECTION,
OR WORKING IN THE ENGINE
COMPARTMENT.
WEAR EYE PROTECTION
AT ALL TIMES!



HEATER-HOT WATER

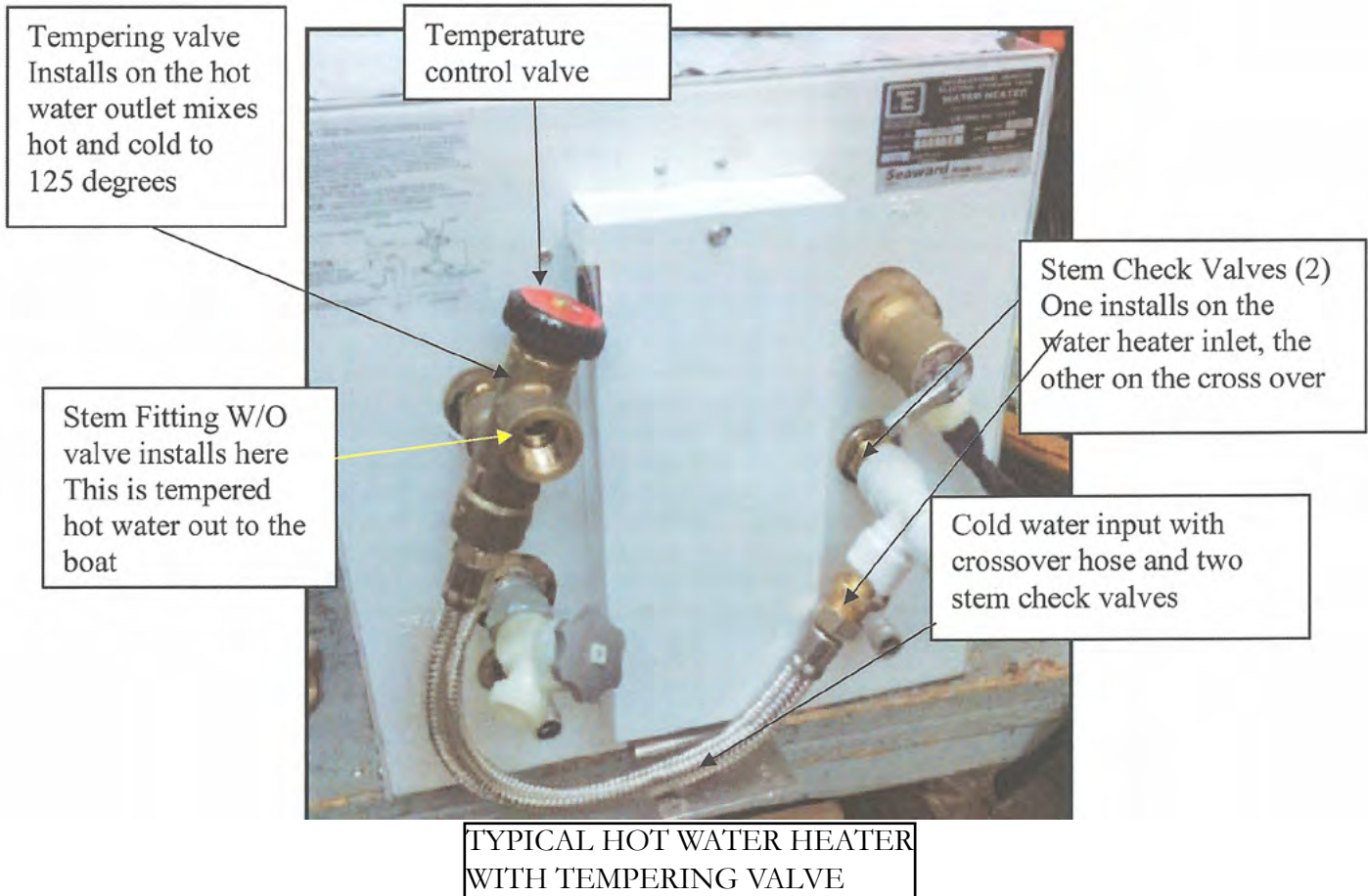

The hot water heater has recirculating ability to keep water warm during cruising. This is accomplished by a set of hoses connected between the hot water tank and the circulating engine water pump. Engine coolant runs through a tempering valve which manages the water temperature when the engine is running. The valve mixes cooler water from the fresh water system with warmer engine manifold water. The valve is factory set but can be adjusted to control the water temperature for a variety of needs and individuals.

If the tempering valve needs adjustment refer to the adjustment information label on the following page. Always check for safe water temperature limits before immersing any body parts in it.

o initially fill the hot water heater, ensure the boat's fresh water tank is full. When the tank is full water will be seen at the deck vent. At the DC side of the main ship's AC/DC panel, turn the fresh water pump to the "on" position. **Make sure the water heater is full of water by opening a hot water faucet until a steady stream flows out.** With the shore power connected, switch on the hot water heater at the AC side of the ship's service panel. The heating element will now begin to heat the hot water tank. Should the hot water heater reset button need to be activated turn off the hot water breaker at the AC side of the main control panel. Then remove the panel cover to expose the reset button. Press the red reset button. On *newer* models there is a round access port on the rear panel to reach and reset the breaker.

Auxiliary Equipment Operation

9. INSTRUCTIONS FOR USE

This Tempering Valve Kit allows the user to adjust the temperature of the water within the water heating system. **Please note** - This is not an anti-scald device.

The range of temperatures attainable from this device are indicated on the Tempering Valve 100°F (38°C) – 130°F (54°C) +/- 10%. If temperatures outside of this range do occur please refer to section 12. Trouble Shooting.

Setting the valve to 125°F (51.6°C)

Step 1: When the valve is correctly installed turn the knob anti-clockwise until it stops (Figure 4). This is the highest temperature setting.

Step 2: Turn the valve 45° or 1/8 of a turn clockwise (Figure 5). The valve should now be set to 125°F (51.6°C) +/- 10 %

Note: The notch on the red dial does not indicate position, following Steps 1 and 2 is the only way to ensure the tempering valve's setting.



Figure 4



Figure 5

Should the need arise there is a drain valve located at the rear of the heater. Always turn the hot water breaker to the “off” position before opening the drain valve. Make sure the water is cold before attempting to open the valve. **The valve runs through the shower sump pump and then overboard.** Contact a marine professional for further information.



CAUTION

TO AVOID POSSIBLE BODILY INJURY DUE TO ELECTRICAL SHOCK DO NOT TRY TO OPEN UP THE HOT WATER TANK COMPONENTS WHILE THE AC POWER IS ACTIVATED.
TURN HOT WATER BREAKER OFF AT THE MAIN AC PANEL.



CAUTION

TO AVOID POSSIBLE BODILY INJURY DUE TO HOT WATER, BE SURE TO CHECK THE WATER TEMPERATURE BEFORE USING IT. THIS IS ESPECIALLY TRUE AFTER CRUISING WHEN THE WATER HAS BEEN TRAVELING THROUGH THE HEAT EXCHANGER HOSES.

NOTICE

TO AVOID EQUIPMENT DAMAGE DO NOT TURN ON THE HOT WATER BREAKER WITHOUT THE WATER HEATER BEING FULL. DAMAGE TO THE HEATER ELEMENT WILL OCCUR.



Note that the hot water heater utilizes a safety device called a T & P valve (See the illustration on previous page). Just as a home unit the valve provides relief should the hot water heater overheats. In an emergency the valve will open and hot water will exit into the bilge.

This situation will cause the bilge pump system to operate until the water supply is disconnected.

As a safety precaution always disconnect the hose from the marina water supply to the water dockside inlet valve on the boat when leaving the vessel for extended periods.

On select newer models there may be a piping connected to a thru-hull from the T & P valve on the hot water heater. In this case a blown relief valve will exit water overboard verses the bilge.

HIGH WATER ALARM-BILGE

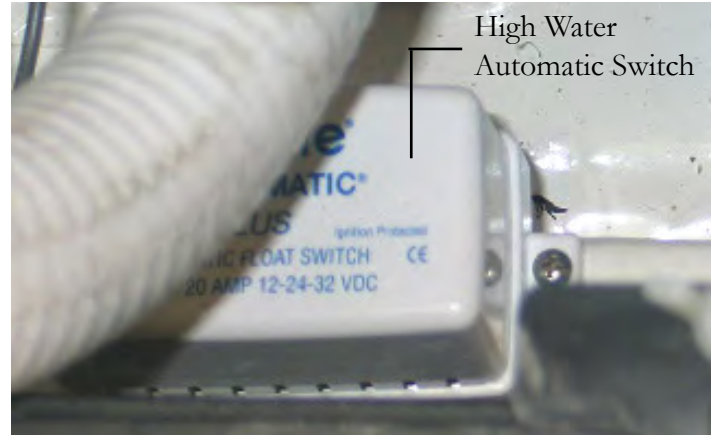

The high-water alarm warns the skipper of a possible emergency in the bilge area. There is an automatic float switch installed in the center bilge. If the water rises over a predetermined level the bilge switch sends a signal to the helm mounted alarm. This sump float switch normally is elevated from the position of the automatic bilge pump switches.

If the alarm sounds bring the vessel back to an idled position in neutral and turn off the engines. Open the engine hatch and find the cause of the problem.

Possible causes are:

1. Engine or generator hose leak.
2. Mufflers or exhaust hose leak.
3. Hull leak due to striking an object.
4. Water or waste tank leak.
5. Plumbing feed hose leak.
6. Seacock leak.
7. Heat exchanger leak.
8. Transducer or underwater light leak.
9. Water heater tank or heat exchanger hose leak.



Helm High Water Alarm

Auxiliary Equipment Operation

MARKERS-FOR SLINGS-TYPICAL

Sling markers may be located on the forward and aft deck near the rub rail. These markers provide a safe location to locate straps to lift the boat. Failure to use marked sling marker locations could cause damage to the boat structure. When lifting the vessel close all doors, hatches and portlights. Make sure the spreader bars are adjustable enough to be wider than the sling beam area. This will allow the slings to hold the weight of the boat properly without forcing the boat structure inward. Make sure there is no pressure on the rub rail or swim platform. **Always use a flat wide belt-style straps as they distribute and hold the boat weight in a more supported fashion.** Do not use the cable-style straps since they may cause hull or rub rail damage. See the technical chapter for more lift information.

NOTICE

TO AVOID POSSIBLE FIBERGLASS DAMAGE,
SET VESSEL FOR EXTENDED STORAGE
ON A FACTORY APPROVED
AND ADJUSTED STEEL CRADLE.
NEVER USE BLOCKING TO SUPPORT THE
VESSEL'S HULL BOTTOM.

NOTICE

AS A SAFETY PRECAUTION,
WHEN THE BOAT IS LIFTED,
TIE A LINE BETWEEN BOTH STRAPS
TO PREVENT THE STRAPS FROM MOVING
FORWARD OR AFT.



OVERBOARD DISCHARGE PUMP (MACERATOR) TYPICAL

The overboard discharge pump (macerator) can be used to pump out the holding tank in international waters. When the monitor panel key is energized to the full start position, the macerator engages to pump the tank waste overboard. *Again, make sure it is legal to pump the waste overboard before you start the operation.* Also, open the waste seacock located in the sump. The pump can be disconnected from the 2 union fittings that hold it for maintenance purposes. The pump is rated for 40 minutes continuous operation. Do not flush paper or feminine hygiene products into the waste system. Keep toilet tissue usage to a minimum. Do not use bleach or toilet cleaners in the waste system. Use only marine approved products. Rinse and flush the holding tank after each pump out. This will dilute any residual waste, and help prevent blockage and reduce odors.

IN-LINE WASTE VENT FILTER

Located in the bilge near the through hull fitting is a long cartridge style filter installed in-line at the waste tank vent hose. This filter removes waste odor from the system while still permitting methane fumes to escape via the hull side. The waste filter is not serviceable. The manufacturer recommends that it be replaced each year. See the systems chapter for additional information. Note that there are union connectors on each end of the filter to aid in removal.

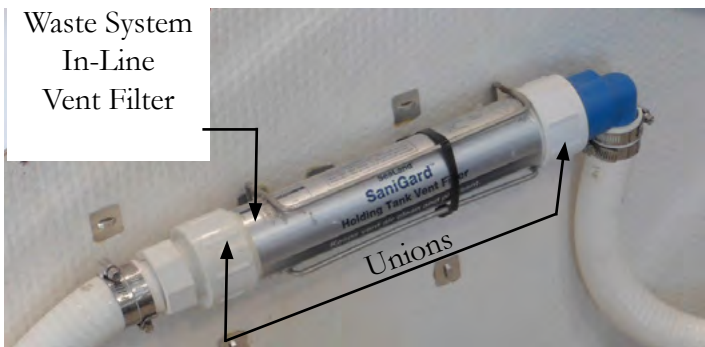

FRESH WATER & WASTE MONITOR WITH OVERBOARD DISCHARGE



TYPICAL OVERBOARD DISCHARGE PUMP

The impeller grinds up the waste as it passes through the macerator. On the macerator shown above the system is protected by a 10 amp breaker located at the salon main DC distribution panel.

Auxiliary Equipment Operation

POWER TOWER (ARCH)-TYPICAL

As part of the innovative design the arch sometimes called a power tower hinges forward for tight overhead clearances such as bridges and restricted storage situations.

The power tower features an aluminum framework and a multi-layered finishing process along with the ability to anchor major electronic equipment.



TYPICAL POWER TOWER- SUNSHADES IN CRUISE POSITION

The power tower can be hinged forward for clearance purposes. Use the switch marked “arch” found on the starboard switch panel to energize the power tower. It connects to a lift actuator motor and a set of hydraulic rams that raise or lower the power tower through the switch.

If towing vessel as part of a wide-load permit make sure arch is completely up. **DO NOT TRAVEL OVER THE ROAD WITH THE ARCH IN THE FORWARD POSITION.**

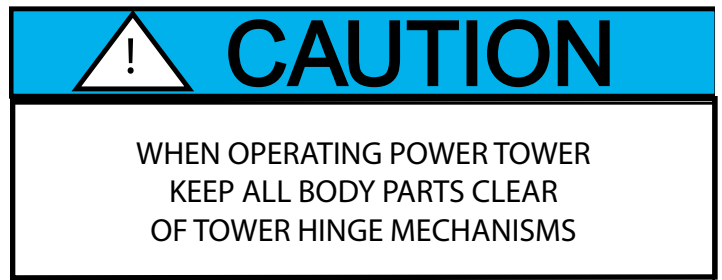

Make sure the operator and all aboard read and understand the above warning.

Before energizing the arch switch explain to all passengers that they maintain a safe distance from the tower hinge mechanisms located at the base of the power tower on the deck. As the operator energizes the switch to hinge the tower forward visually monitor the port and starboard deck to ensure all passengers are clear of the hinge mechanism. This same procedure applies for lowering the mechanism to the cruise position.

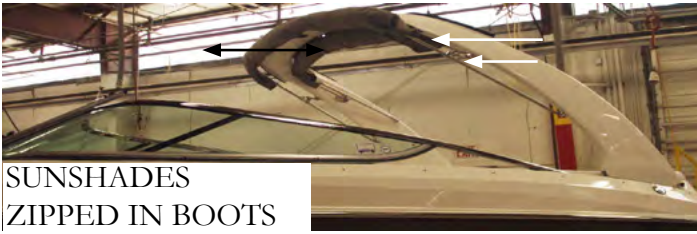

SUNSHADES
ZIPPED IN BOOTS

Located at the starboard fire wall bulkhead (bow end of bilge) is the power tower actuator control box. The purpose of this device is to provide overload protection for the port and starboard actuators that move the power tower forward and aft (see the illustration).

In addition, the control breaker protects the up and down wiring circuit to the dash for the power tower circuit.

If a breaker “pops” be sure to determine the cause of the malfunction before resetting the device.



TYPICAL POWER TOWER SHOWN IN FULL FWD.
TILTED POSITION



NOTICE

Check your state laws and regulations before attempting to tow this vessel. Special permits and equipment may be needed.

For highway towing the power tower shall be in the complete forward position and all canvas shall be in their dedicated boots. All attached canvas bow hardware shall be checked for tightness before and after towing. Cockpit carpet shall be rolled up and stored in a dedicated cockpit locker.

Auxiliary Equipment Operation

PRESSURE PUMP-FRESH WATER

Your vessel features a variable speed fresh water pressure pump. The variable speed allows for additional water flow at peak times such as using the forward and aft showers at one time. It is important not to operate the pump unless there is water in the fresh water tank. The pump is controlled by a breaker on the main DC control panel. Energizing the switch allows the pump to build the water pressure in the distribution lines to 35 psi's.

When the pump reaches a level of 35 psi the pump should automatically shut off. If the system drops below a certain pressure then the variable speed pump will restart. If the pump cycles on and off with no water being used, a leak in the water system is likely.

Periodically remove the water inlet filter and clean it. Additional filters can be ordered through your Regal yacht dealer or marine outlets.

Be sure to turn the fresh water pump at the main salon DC panel off before performing any type of maintenance.

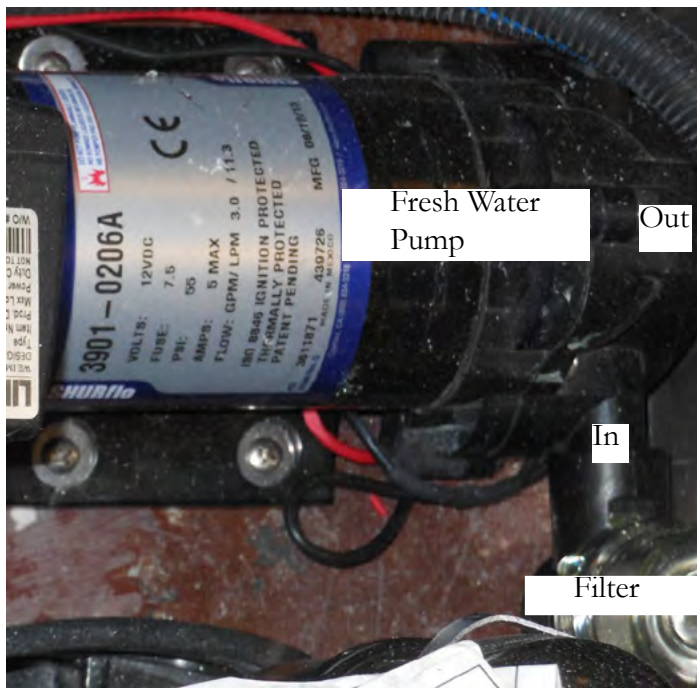

TYPICAL FRESH WATER PUMP



SATELLITE RADIO

This *option* is currently available on all Regal models. Sirius satellite radio features over 120 channels of music entertainment completely commercial-free along with sports and news channels. Sirius emphasizes the music and entertainment you want. Channels use the most updated digital filtering available for the clearest sound. Sirius uses three satellites flying over the United States for coast to coast coverage with high elevation angles. The result is a clearer line of sight and less signal blocking.

The system consists of the stereo receiver (sometimes called the head unit), radio tuner and antenna. With these components and an active account initialized by the customer on delivery your Sirius system should be ready to operate.

Following are the activation steps to be taken:

A. Unit must be completely installed and the antenna must have a clear view of the sky.

B. Turn on the radio and go to satellite mode.

C. Confirm reception by tuning to SIRIUS WEATHER & EMERGENCY//CHANNEL 184. If you are not receiving Channel 184, please refer to the radio manufacturer owner's manual.

D. Call SIRIUS sales support 1-888-465-8516 or customer care 1-888-539-7474.

E. Please have your name, address, phone number and the SIRIUS ID#ESN available for the agent.

Auxiliary Equipment Operation

SHOWER-TRANSOM TYPICAL



If installed, a transom shower is located at the aft starboard cockpit. The shower head features a flexible extended hose with hot and cold water. Like residential plumbing, the red knob denotes hot water and the blue knob cold water. When using this feature balance the hot and cold knobs to achieve a desired operating temperature. Turn the knobs to the “off” position when not using the unit.



SPOTLIGHT-TYPICAL



The optional “5” spotlight/floodlight uses a high-powered, dual focus sealed beam bulb. With a high candle power output the unit can illuminate objects up to 1/4 mile away. Notwithstanding, the huge candle power spotlight is perfect for docking or mooring.

The unit rotates up to 350 degrees and includes a vertical arc

of 70 degrees and an easy to use “joystick” style remote control. The spotlight uses a 12 volt operating system and is constructed of stainless steel or chrome brass for years of carefree service.

The spotlight control panel uses a 2 way switch to control the type of light output. To control the direction a 4 position joystick style switch is used.

The 2 way switch in the center position is “off”. In the “up” position the light output is a spotlight. In the “down” position the light output is a floodlight.

To move the light upward press and hold the joystick “up”. To move the light downward press and hold the joystick “down”.

To move the light counterclockwise press and hold the joystick to port until the desired directional movement is achieved.

To move the light clockwise press and hold the joystick to starboard until the desired directional movement is achieved.

If storing the vessel outside in colder climates turn the spotlight so the lens faces the stern of the boat to help prevent a broken lens due to unidentified flying debris. Of course another option would be to cover the lens face.

Auxiliary Equipment Operation

SWIM (BOARDING) LADDER-TYPICAL

When using the swim (boarding) ladder open the hatch and slide the ladder out to the end of the travel. Then flip the ladder over and let it down gently. Make sure you keep your hands and fingers clear of any moving ladder parts especially the hinged top.

When not using the swim ladder be sure to keep the ladder cover over the ladder to prevent tripping and falling accidents.

Insist that only one person use the ladder at a time. When finished with the ladder flip up the lower section of the ladder and slide the ladder assembly in as far as possible. Lower the fiberglass ladder cover to secure it.

Periodically check the ladder hardware for tightness and corrosion. Replace fasteners and lubricate hinges as needed. Read and understand all warning and information labels found on the swim platform and ladder cover. Never exceed the maximum poundage recommended for the swim platform as noted on the label.

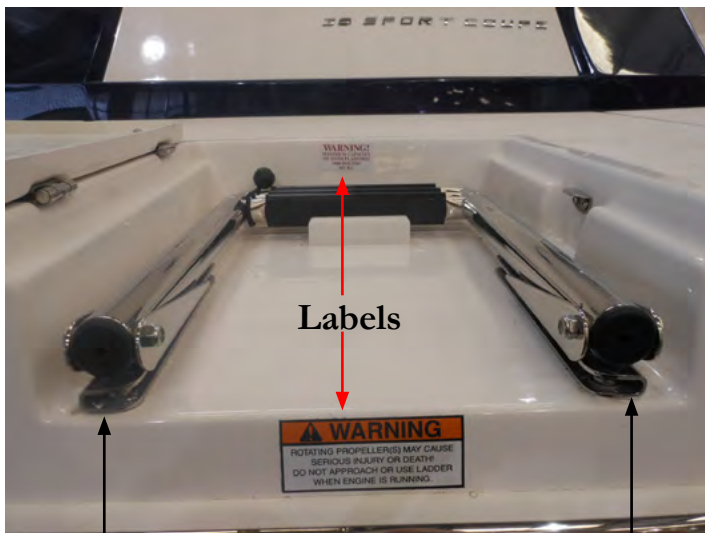

**Keep Body Parts
Away From
Rotating Components**

	WARNING
TO AVOID BODILY INJURY TURN THE ENGINES AND GENERATOR OFF AND REMOVE THE IGNITION KEYS WHILE PEOPLE ARE SWIMMING NEAR THE VESSEL AND/OR USING THE SWIM PLATFORM OR LADDER.	



SWIM PLATFORM

The swim platform is used with the boarding ladder to enter and exit the water. Never dive from the swim platform or swim under it. The swim platform is not intended to be used for storing heavy objects. Keep the platform surface free of objects to prevent bodily injury due to falling. Periodically inspect all swim platform fasteners and stanchions under the platform for tightness and corrosion. Replace parts as needed.

Do not exceed the swim platform recommended poundage capacity.

If installed, use the swim platform cleats for temporary tying only such as stopping at an on-the-water restaurant or fuel dock. Use the other deck cleats for permanent moorings. When securing lines leave enough slack for local tidal changes.

Never use the swim platform cleats for towing!

Never attempt to lift the boat using the swim platform cleats or any other cleats on the vessel! See the section on sling markers. Never swim around or under the swim platform while the engines are running due to the effects of carbon monoxide poisoning. **Read and understand all CO labels in the safety on board chapter.**

 **WARNING**

TO AVOID BODILY INJURY
TURN THE ENGINE OFF
AND REMOVE THE IGNITION KEY
WHILE PEOPLE ARE SWIMMING
NEAR THE VESSEL, USING THE SWIM
PLATFORM OR LADDER.

 **WARNING**

AVOID SERIOUS INJURY OR DEATH!
NEVER OPERATE THE VESSEL
WITH PEOPLE ON TOP OR HOLDING ON TO
THE SWIM PLATFORM
STRUCTURE OR HARDWARE.

Auxiliary Equipment Operation

THRUSTER-BOW (TYPICAL)

General Safety Notices:

1. Be sure to read and understand the safety information and all thruster operation information before attempting to use the thruster system.
2. Do not operate the bow thruster system close to swimmers as a high powered suction is produced at the propellers.
3. Make sure the propeller lock nut is torqued to the required foot pound specification.
4. When servicing the unit be sure to turn the thruster designated battery switch to the service position (to far-right) and insert a tie wrap in the selector slot for back-up protection. See the typical set-up below.

Below is a typical wiring layout (sump) for optional thruster (note that this one also includes the optional hyd. swim platform).

Using Thruster:



To use the thruster first make sure the house battery switch is activated. Next, energize the accessory switch on the helm starboard switch panel. This switch also controls the optional hydraulic swim platform should it be installed.

There is a joystick on the helm and it can assist in slow speed maneuvering especially around a dock or close mooring situations. It operates similar to the engine joysticks.

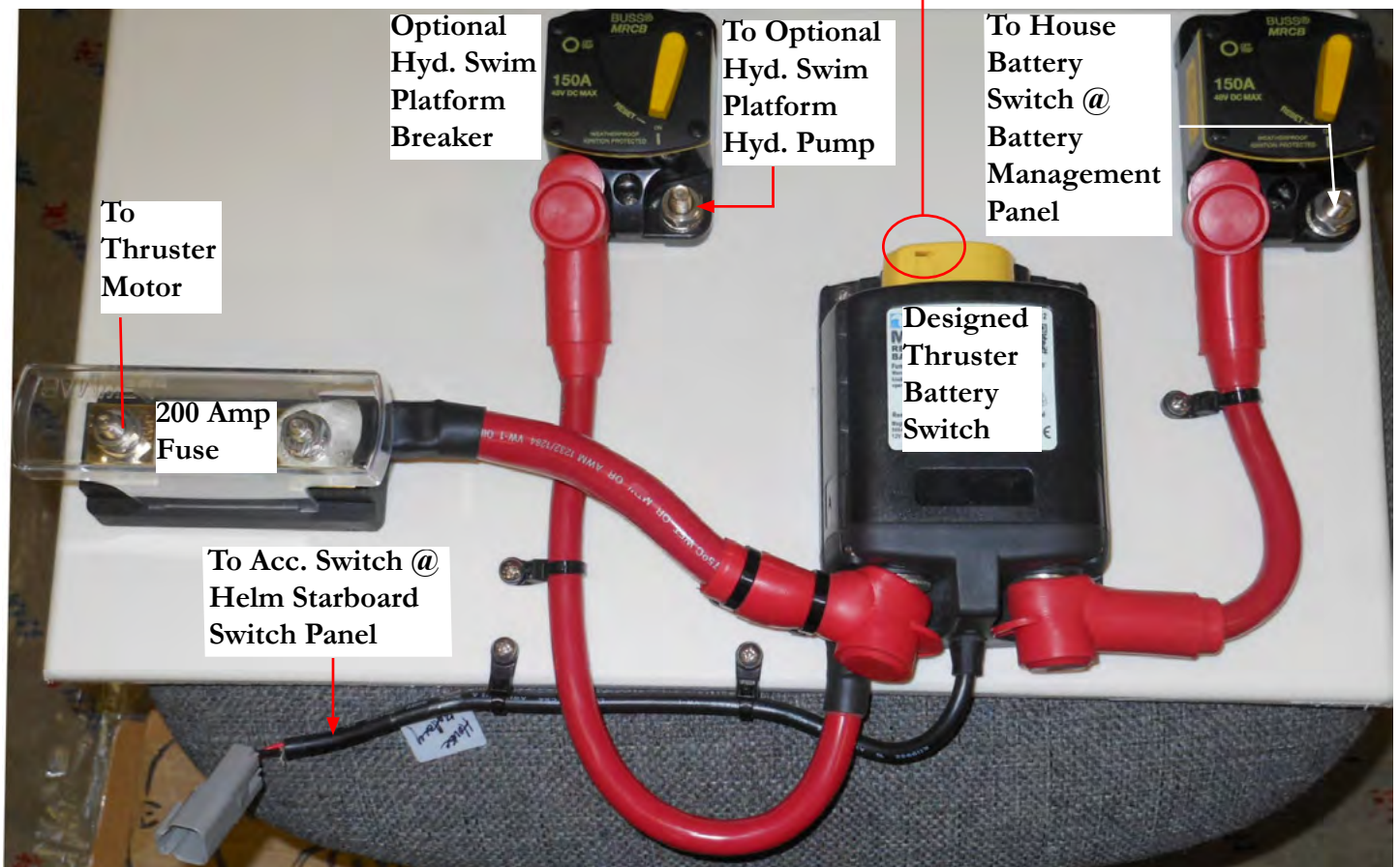



Chapter 7

Never run the thruster dry; it will weld the relay contacts as it becomes a generator in spool down.

Do not make quick changes from one direction to the other direction, or it will damage the unit.

The minimum running voltage for the thruster is 10.5 volts; therefore the main engines should be running to maintain this voltage requirement.

Auxiliary Equipment Operation

UNDERWATER LIGHTING

OVERVIEW

The underwater light option provides high output, long life and low heat emission. The lights are made from a high impact resistant polycarbonate housing. The lights are installed under the transom for maximum efficiency. Their beam is blue for increased underwater penetration.

These lights are based on LED technology which stands for light emitting diode which can produce various colors depending on the electron line-up inside the semiconductor body of the device.

OPERATION

The underwater lights are energized through the accessory switch located at the starboard helm switch panel. The lights are protected by a breaker located at the helm under the steering wheel on the lower breaker panel.



Cosmetic Care & Maintenance

COSMETIC CARE



This chapter covers the general care of your Regal boat. Be sure to read and understand all vendor supplied information on cosmetic care. Many cosmetic care topics are described and expanded in the following pages. For selected items there may not be specific

vendor information available in the owner's information packet. Therefore, we have provided customer cleaning information as needed on each of these topics.

Where cleaning methods are suggested try them on a small area before applying to the entire surface. Never use toxic or caustic chemicals on your yacht. Read and understand each cleaning agent before using it. The labels will alert you to limitations and safety information for each cleaner.

Never mix cleaning agents since this may produce an unsafe chemical reaction which could be toxic, produce fire or explosion and/or effects that may be harmful to the human body.

Provide fresh air while using cleaning agents to reduce any effects of chemical inhalation by opening hatches, port lights and the main companionway door. It is recommended to vacate the area until any chemical odors are diminished.

Most of all, use common sense!

Cosmetic Care & Maintenance

BILGE/ENGINE COMPARTMENT



Check the transom area for loose hardware. Do not use any flammable products in the bilge. Use environmentally approved procedures to dispose of oily or soiled cloths.

Always keep the bilge pumped out and free of accumulated debris. If oil accumulates on the engine compartment floor becomes it is usually related to engine oil lines, a loose component such as an oil filter, oil pan drain bolt or a leaky gasket/O-ring. Always find the cause of smaller problems before they become larger more expensive ones.

The engine compartment, bilge or sometimes called the sump features a light colored gel finish that will be beneficial in finding leak sources.

A periodic bilge cleaning with a brush and bilge cleaner (purchase at a marina or supplier) will be helpful in maintaining an orderly and safe bilge since accumulated dirt and fluids could cause someone to fall. *Do not pump bilge contaminated oil overboard but deploy it to a waste receptacle for recycling.* Check the fuel system including all hoses, tanks and connectors for possible leaks and deterioration. A stained area normally could suggest a hose or connection leak.

Inspect all wiring including connectors and hangers for tightness. Clean fuel filters as suggested by the engine manufacturer.

Check all engine and water/waste hoses for tightness and deterioration. Tighten all hose clamps as needed.

Check all battery hardware and terminal connections. Fill the battery cells with distilled water (wet-cell type only) to the battery manufacturer's suggested level.



CABINETS



The handcrafted interior cabinets feature a sprayed clear coat finish. This clear coat produces a hard finish which is baked on and is very resilient. Use a warm solution of water and mild detergent to keep the cabinet surfaces looking new. Wipe the surface with the solution using a soft damp cloth, and dry with a soft clean towel. This procedure should eliminate most stains and oily finger marks. Stay away from heavy scrubbers and compounds which may harm the surface. Avoid polishes containing silicones.

Use the specifications below as a guide for any cabinet repairs or interior refurbishing needs.

APPLICATION	ADHESIVE
WOOD TO WOOD	WOOD GLUE
WOOD TO FORMICA	CLEAR SILICONE
FORMICA TO FORMICA	CLEAR SILICONE
SINK INSTALL	CLEAR SILICONE
CORIAN TRIM	SIKA FLEX 291
MIRROR TO FORMICA	MIRROR MASTIC
GRANITE TO WOOD	SIKA FLEX 291

Cosmetic Care & Maintenance

CANVAS CLEANING INSTRUCTIONS



Sunbrella type canvas should be cleaned regularly before substances such as dirt, roof particles, etc., are allowed to accumulate on and become embedded in the fabric. The fabric can

be cleaned without being removed from the boat. Simply brush off any loose dirt, hose down, and clean with a mild solution of natural soap in lukewarm water. Rinse thoroughly to remove soap. **DO NOT USE DETERGENTS!** Allow to air dry.

For heavily soiled fabric, remove the top from the frame. Soak the fabric in a solution that has been mixed to the following proportions: 1/2 cup of Clorox bleach and 1/4 cup of Ivory or Lux soap (liquid or soap) per each gallon of lukewarm water. Allow the fabric to soak until the bleach has killed the mildew and the stains can be brushed out with a common kitchen scrub brush. Rinse the fabric thoroughly in cold water to remove all the soap. This may require several rinsings. Incomplete rinsing can cause deterioration of sewing threads and prohibit the fabric from being properly retreated. Allow the fabric to dry completely. Do not steam press or dry in a gas or electric dryer.

Excessive heat can damage and shrink the fabric since it is heat sensitive.

This method of cleaning may remove part of the water and stain repellents that was applied to the fabric during its manufacture. It is recommended to retreat with such water repellency products as Apeal and Uniseal. We do not recommend any wax based treatments such as Thompson's Water Seal or any of the silicone products such as SC-15 or Aqua-Tite. Wax based products prevent the fabric from breathing, and encourage mildew growth while the silicone products interact with the original fluorocarbon finish and seem to cause a rapid loss of water repellency. Scotchguard has not been found to be very effective for restoring water repellents to Sunbrella. It seems to work well in the short run, but not long term.

CLEAR VINYL, ZIPPER & SNAP CARE

Never store canvas wet or in an unventilated, moist area. Always roll the canvas instead of folding. This is of particular importance on side curtains or any other part with the clear vinyl "glass". Roll the top carefully around the bows and cover with the storage boot provided.

The clear vinyl "glass" used in side curtains, aft curtains, visors, and camper enclosures is very susceptible to heat and cold. Keep vinyl curtains from touching metal tubing to minimize burning the vinyl.

If the boat is stored with top, side curtains and aft curtain in place, heat build up inside the boat may discolor the vinyl.

To clean the clear "vinyl" glass, use a solution of Ivory or Lux soap, liquid or flakes, and lukewarm water. Allow to air dry. Never use any type of abrasive cleaner as it will scratch the "vinyl" glass. There are many cleaners and scratch removers on the market specifically for clear vinyl. Handle the clear curtains carefully. They are soft and prone to scratching.

Canvas parts are designed with zippers. When zippers are new they can be a little difficult to use. Zip carefully without forcing the zipper or the material. They will loosen with use. A zipper lubricant may be used to help new zippers as well as maintaining used ones. The most vulnerable part of the zipper is the starts. Use care when starting the zipper.

Canvas snap fasteners should be unsnapped as close to the button as possible. Never remove canvas by pulling roughly on the edge of the material. This can damage the canvas as well as the fasteners. Use petroleum jelly on snaps to keep them from developing corrosion especially in harsh environments.



CARPET-INTERIOR

The interior cabin carpet is produced from 100% BCF nylon. The nylon is treated topically with an anti-soil chemical that will assist in keeping your carpet looking beautiful longer.

General Care and Maintenance

Your carpet is a high luster nylon that can look great for years to come provided you follow some basic care and maintenance. Nylon is the highest performing synthetic fiber in the market and has dense pile that will give a long wear cycle and high performance.

The following will help maintain your carpet:

Regular Vacuuming

This is the most important single factor in keeping carpet beautiful is to vacuum it on a regular basis. Sand and dirt particles will abrade the carpet fibers in a faster manner. This abrasion will cause non-repairable damage to the fiber that will reduce the carpet's life expectancy. Use a vacuum with a beater bar verses a vacuum alone as it will lift the fiber and help open the carpet to allow the vacuum to remove grit.

Professional Cleaning

Interior carpet is the same as high-end residential carpet and the carpet should be treated accordingly. Periodic professional carpet cleaning using either the hot water extraction or dry cleaning powder method will help maintain the beauty of your carpet. This will remove the ground in soil.

Spills

At some point in the life of the carpet, there is always the potential for a spill. Remove the spill immediately. The quicker the spill is removed, the easier it is to clean up. The longer a spill stays on the carpet, the more likely it is to stain the fibers, regardless of the cleaning treatment used. When a spill occurs, always blot the area being cleaned. Do not rub or scrub. Follow the cleaning instructions.

Cabin Door/Cockpit Entrance Mats

Entrance mats on a boat are very important to help reduce the dirt and sand that is brought on to the carpet. Also, entrance mats reduce the amount of moisture being tracked on to the carpet, which will cause matting of the fibers.

Mats can be ordered from your Regal dealer. These mats fit the nautical decor and provide the best surface to catch dirt and sand particles. Also, entrance mats can be obtained from local sources. Look for mats with a non-skid backing.

Cosmetic Care & Maintenance

CARPET-COCKPIT TYPICAL

Regal cockpit carpets feature an *aqua tread* backing which permits the carpet to weep moisture and still retain steadfast non-slip characteristics. Also, this backing permits the cockpit carpet to lay flat on the fiberglass deck surface without buckling.

Also, your cockpit carpet is produced with 100% ultraviolet resistant fibers. The carpet boasts a special blend of resilient fibers to withstand traffic and retain its beauty.

Cockpit carpet is designed to take a lot of abuse from the sun and sea but it periodically needs to be cleaned which is a different procedure from household types.

To clean cockpit carpet follow these steps:

1. Scrub the soiled areas with a stiff nylon or soft bristle brush to loosen the dirt and grime.
2. Vacuum the carpet thoroughly using a wet-dry type of cleaner.
3. Pour one cup white vinegar into a 1-quart spray bottle; fill with water.
4. Spray the soiled areas with the vinegar solution until saturated; let stand 15 minutes.
5. Brush the soiled areas once more; the dirt and grime will be released from the carpet fibers.
6. Rinse the carpet, with a garden hose at low pressure.
7. Remove any remaining water with a wet-dry vacuum. Allow the carpet to dry completely.
8. Fluff up the clean, dry carpet with the brush or a carpet rake. If applicable, apply vaseline to the snaps.

Stain Removal

Olefin fiber used in the cockpit carpet is very resistant to stain. However, when a stain does occur, follow the stain removal chart on the following page. Remember, remove a stain as soon as possible, as this enhances the ability to remove it.

Most stains should easily be removed from Olefin fibers. If the stain persists, the cleaning procedure should be repeated to ensure stain removal. Again, the sooner the stain removal process is started, the easier the stain will be to remove.

Under no circumstances should any solvents normally associated with the dry cleaning of apparel (perchloroethylene, carbon tetrachloride, etc.) be utilized, as permanent damage to the fiber will result.

Cockpit Carpet Stain Removal Chart

Miscellaneous Stains	Removal Process
Coffee, Tea, Coke, Fruit Juice, Ice Cream, Motor Oil, Egg, Grease, Catsup, Chocolate, Milk, Rust, Latex Paint, Water Colors, Berry Stains, Blood, Salad Dressing, Furniture Polish, Clay, Wine, Dye, Mayonnaise, Fish Formula or Urine	Apply warm water and household detergent in minimal amounts to the stained area. Sponge or scrape the stain until it is removed. Then wash thoroughly with clean water.
Persistent Stains	Removal Process
Chewing Gum, Crayon, Ink, Wax, Lipstick, Tar, Polish, Oil Paint	Apply warm water and household detergent. Work mixture well into the stained area, and then flush with warm water.



To store cockpit carpet, roll it tightly. This will keep the carpet from developing wrinkles which result from folding the carpet.



COUNTERTOPS

Solid surface countertops feature elegance and durability. Periodic maintenance will ensure its beauty. It withstands heat much better than ordinary countertop materials but you must still use a hot pad or trivet when taking materials directly out of the oven or stove top to protect from damaging the surface. Avoid cutting directly on the surface.

Another feature of solid surface countertops is that they are non-porous. Therefore, dirt and germs do not penetrate it. Also, it will not support the growth of germs and mildew. To disinfect or clean see the table. You can use a green Scotch-brite pad along with the table solutions to remove stubborn stains.

Darker colors tend to require more frequent cleaning to maintain a uniform finish. Also, darker colors tend to show fine scratches more easily and require more attention than lighter colors.

The material is a matte or satin finish. To remove scratches and nicks, sand the surface with 180-220 grit sandpaper until the nick is gone. To restore the finish use an abrasive cleanser and a green Scotch-Brite pad. Wrap the sandpaper around a block of wood. The block will sand the areas flat instead of creating hills and valleys.



PROBLEM	SOLUTION
Dirt and Residue	Use soapy water, ammonia based cleaner (not window cleaner), rinse and <u>wipe completely dry</u> . Commercially available solid surface cleaners such as Clean Encounters® will work well too.
Preventing Hard Water Marks	Rinse & <u>wipe completely dry</u> after cleaning; clean up spills before they dry.
Removing Hard Water Marks	Use a cleaner formulated for removing hard water marks such as CLR or Lime-A-Way
Difficult Residue	Spray residue with Deep Cleaner for DuPont Corian from Stone Care International. Follow instructions on the bottle. Wash area with soapy water, rinse and <u>wipe completely dry</u> .
Disinfecting	Occasionally, wipe surface with diluted household bleach (1 part water/1 part bleach). Rinse top thoroughly with water and <u>wipe completely dry</u> .

Cosmetic Care & Maintenance

BBQ SURFACES

The best way to clean metal surfaces on your BBQ is to wipe them down with a damp cloth and then thoroughly dry. Stubborn spots caused by spillage and discoloration from heat may be removed by lemon juice, vinegar, or chrome polish. Keep these cleaning products away from porcelain enamel surfaces. Never use coarse cleaners, steel wool scouring pads or metal brushes to clean stainless steel. These methods will allow deep scratches to develop on the stainless steel that cannot be removed.

PORCELAIN ENAMEL

Porcelain enamel is glass fused on steel at very high temperatures. It is not overly delicate but must be treated like glass. Sharp blows, radical changes in temperatures, etc; will cause the enamel to crack or chip. Some foods contain acids which will dull the finish of the enamel.

FABRICS-INTERIOR

Clean flat good interior fabrics with dry cleaning fluid style cleaners approved for use with soft fabrics. Allow adequate ventilation and follow the label instructions carefully. Use protective eye wear and gloves. Do not inhale the chemicals.

Use a soft cleanser with feldspar to clean stubborn marks or stains on wallpaper.

Normal interior vinyl such as the headliner need a mild soap and water solution. Rinse immediately with clean water and wipe dry. Always test a small area with a cleaner before applying it to a larger area.





FIBERGLASS & GELCOAT



Routine maintenance is the only practical way to keep the surface of your boat looking shiny and new. Most objects left outdoors will gradually deteriorate from exposure to the sun, water, dust and pollution. Such outdoor exposure can cause your boat's gelcoated surface to change or fade. Darker colors tend to fade more rapidly than lighter colors because they absorb more of the sun's rays (ultraviolet and infrared).

Basic maintenance includes monthly washing of the boat's surface to remove normal accumulation of soil and stain. Use a mild detergent such as dishwasher powder or liquid. Do not use automatic dishwasher detergent. Avoid any kind of alkaline cleaners such as tri-sodium phosphate (TSP), abrasives, bleaches and ammonia. For best results use cleaners that are recommended for fiberglass.

It is recommended that you wax the gelcoat surface twice yearly to prevent loss of gloss and to protect the finish. Use only waxes for fiberglass and follow the label instructions. Apply a 3' x 3' section at a time using clean applicator cloths or a buffing bonnet. When a haze develops, use a power buffer at low speeds (1200-2000 rpm) to remove the haze. Keep the buffer moving to avoid heat build-up. Never wax gelcoat in direct sun.

When the washing and waxing as recommended does not restore the shine it may be necessary to use a fine rubbing compound. Do not apply rubbing compound in direct sunlight. A power buffer at lower speeds does an excellent job to remove impurities from the gel coat that cause dulling. Use light pressure and keep the buffer moving. Re-wax after compounding to buff the surface.

"Hairline cracks" or "spider webbing" could develop in the gelcoat surface of a hull or deck. This can be caused by impact or other factors. Small air pockets or gouges may also occur through normal **wear**. These do not affect the strength of the hull or deck and can be repaired by yourself, a marine professional or a Regal dealer.

The affected area should be chipped or sanded away and a thin layer of color matched gelcoat applied. This layer is then sanded smooth and buffed to its original luster.

Most minor scratches, nicks, and dents can be removed by compounding the surface. Marine type compounds can be found at most auto body supply stores.

Specify a number 25 which is a coarser compound up to a number 55 being less coarse. Various glazes and polishes are available as needed. Ask your marine professional or Regal dealer for more information. Fiberglass hulls are strong but they can be damaged. A fiberglass hull has virtually no internal stresses. Thus when a part is broken or punctured, the rest of the hull retains its original shape. A severe blow will either be absorbed or result in a definite localized break. A break of this nature should be checked and repaired by a marine professional or a Regal dealer.

MINOR REPAIRS

You will need the following materials for minor repairs:

- Gelcoat
- Clear Liquid Catalyst
- Putty Knife
- Razor Blade
- Fine Sandpaper (400,600,1000)
- Wax Paper (to cover repair area)

Cosmetic Care & Maintenance



WARNING

AVOID BODILY INJURY!
GELCOAT & FIBERGLASS RESIN
ARE FLAMMABLE.
WORK IN A WELL VENTILATED AREA
FREE FROM OPEN FLAMES.
DO NOT SMOKE!

For minor repairs refer to the following procedure:

1. Clean the area to be repaired and get rid of any wax or grease residues.
2. Clean out scratches, chips, and nicks.
3. Sand area to be repaired so gelcoat will bond.



CAUTION

AVOID BODILY INJURY!
WAXED GELCOAT SURFACES CAN BE
VERY SLIPPERY. DO NOT WAX NORMAL-
LY USED AREAS OF THE DECK, LINER,
OR GUNWALES. DO NOT WAX ANY TEX-
TURED OR NON-SKID SURFACES SUCH AS
FLOORS, WALKWAYS, STEPS, LADDERS
OR SWIM PLATFORMS.
ALWAYS WEAR NON-SLIP FOOTWEAR
WHILE ON BOARD THE VESSEL.

4. In a separate container, measure only the amount of gelcoat you will need. Mix a ratio of 2% ratio of catalyst to the amount of gelcoat being used (a spoonful of gelcoat will require only a drop or two of catalyst). Do not pour any unused portions of the gelcoat/catalyst mixture back into either original container.

5. Apply gelcoat to area leaving a slight lift above the surface.

6. Cover the area with wax paper. It will help the mixture to set up faster.

7. Remove wax paper and shave off any extra gelcoat with a razor blade.

8. After the area is shaved smooth, start with the 400, 600, and finally 1000 grit sand papers.

9. Buff the area with compound, polish and a finish wax. You may notice a difference between the repaired area and the original finish due to the natural weathering process.



FLOORING-HARDWOOD

Your vessel may have engineered hardwood floors highlighting the interior. Your flooring was chosen because of its beauty, durability and care-free maintenance. Several types have or are being used including light maple, walnut, cherry, cherry-holly, and bamboo.

Here are some do's and don'ts to follow in keeping your marine flooring looking new:

First, do remember that if you have been cleaning residential floors with vinegar and water, oil soap, furniture polish or window cleaner, you may be ruining your costly investment. These cleaners are a big no with hardwood floors.

Excessive wet mopping with water and vinegar can cause wood to expand, possibly permanently damaging the floor in addition to dulling the finish. Other cleaners that have silicone, wax or oil soaps can leave a residue on the finish and may cause the floor to be slippery which is what you do not need with a boat.

One residue-free, proven hardwood floor cleaner formulated specifically for polyurethane-finished hardwood floors is Bona Kemi's Swedish Formula® Hardwood Floor Cleaner. This environmentally friendly, non-toxic, ph-neutral cleaner effectively cleans dirt, grease and sticky spills without leaving any dulling residue. Apply per container directions.

Preventative care of your floors is also extremely important for keeping hardwood floors looking like new. Vacuuming or sweeping floors regularly, promptly removing spills, and placing mats at cabin door and cabin stairway landing can be effective in trapping damaging sand and dirt particles before they can damage the floor. Avoid walking on floors with high heel shoes. Walking or tennis shoes with soft soles are better and safer to help prevent falls while on the vessel. The harder heels especially black ones tend to leave scuff marks on the floor surface. It is a good idea to keep the nails of pets trimmed, too.

Note: Use a soft application pad inserted in a long handle to apply product. Rinse often in a clean bucket with warm water which are available at most "box" stores.

Cosmetic Care & Maintenance

GAUGES/SWITCH PANELS



Sometimes gauges develop condensation inside their faces. in high humidity environments. To eliminate the condensation droplets, energize the instrument lighting and the heat over a short period of time This process will evaporate the gauge condensation.

For normal dirt and dust accumulation clean with soft cloth and warm water. Dry with a soft cloth or chamois. Near salt water environments deposits can build up on the instrument bezels and faces. Use a soft damp cloth to remove the deposits. Do not use abrasives or rough, dirty cloths to wipe instruments.

Follow the same procedure for all switch panels. Do not use any of the following on panels:

1. Lacquer Thinner
2. Dry Cleaning Fluid
3. Acetone
4. Carbon Tetrachloride
5. Benzine
6. Silicone Spray
7. Gasoline



HULL/DECK

HULL BOTTOM

Never use wire brushes or highly abrasive scouring pads on your hull bottom. It could damage the gelcoat surface or the bottom paint. The bottom of your boat needs to be clean since the build up of natural coatings from water or marine life can potentially create drag and affect boat performance. Use a turkish towel or for heavier build-up a piece of rug to clean the bottom.

HULL/DECK

For normal dirt and insect residue find a soft bristle brush on a long telescopic handle at an automotive store. A good brush is designed with a curved soft base to protect objects it comes in contact with while scrubbing. Rinse down the hull with a hose to loosen up the dirt. Use a mild soap solution in a bucket. Use up and down strokes to clean the hull sides. Rinse off until all residue is removed.

MICROWAVE OVEN



1. Turn off the oven.
2. Keep the inside of the microwave clean. When food splatters or spilled liquids adhere to oven walls, wipe with a damp cloth.

A mild detergent may be used on extremely dirty surfaces. Avoid the use of sprays and other harsh cleaners as they may stain, streak, or dull the door surface.

3. The outside surfaces should be wiped with a damp cloth. To prevent damage to the operating parts inside the oven, water must not enter the ventilation openings.
4. Wipe the door and window on both sides, along with the door seals and related parts frequently with a damp cloth to remove any spills and splatters. Do not use any abrasive cleaner.
5. Do not allow the control panel to become wet. Clean with a damp cloth. When cleaning the control panel leave oven door open to prevent the oven from accidentally turning on.
6. If steam accumulates inside or outside of the oven door, wipe with a soft cloth. This may occur when the microwave is used in high humidity conditions and this is normal.
7. It is occasionally necessary to remove the glass tray for cleaning. Wash the tray in warm sudsy water or in a dishwasher.
8. Remove odors from your oven by combining a cup of water with the juice and skin of one lemon in a deep microwaveable bowl, microwave for 5 minutes. Wipe thoroughly and dry with a soft cloth.



CAUTION

**AVOID BODILY INJURY!
GELCOAT SURFACES CAN BE VERY
SLIPPERY.
ALWAYS WEAR NON-SLIP FOOTWEAR
WHILE ON BOARD THE VESSEL.
ALWAYS RINSE SURFACES ADEQUATELY
TO AVOID SLIPPING
ON SOAPY SURFACES!**

Cosmetic Care & Maintenance

PLASTICS

There are different types of plastic aboard your vessel. Use plastic cleaners and polishes recommended for marine use only. Use proper applicators. Read all instructions carefully. Test the product in a small area first. Use a soft rag and always rinse the surface with water. Ammonia based cleaners will damage plastic parts.

One of the basic rules to cleaning plastic is never use abrasive cleaning products. Even hard plastic surfaces are easily scratched. Stay away from steel wool pads, powdered cleaners with abrasive qualities, or harsh detergents.

Instead use sponges, soft cloths, and mild detergents when cleaning plastic.

While cleaners in aerosol cans are convenient they may not be the best for certain types of plastic. Glass cleaner in a can or a spray bottle is not safe to use on your marine toilet fixture or toilet seat. Many times pits will develop over time and the toilet/seat will appear mottled and will not appear clean no matter how hard you scrub.

Refer to a marine store which possesses the expertise and experience to assist the boat owner in selecting the right cleaner for his marine plastic onboard needs.

RANGE/STOVE

Clean the cook top before you use it for the first time. A thorough cleaning with a recommended product such as Cerama-Brite Cook Top Cleaner will put a clean shiny coating on the cook top before its initial use.

Always remove food spills, grease splatters, and metal rub-off from utensils. First, use a razor blade scraper to remove all spill overs. Then clean the cook top with a paper towel or a clean soft cloth and a recommended cleaner. After using any cleaner always wipe the cook top with a clean, damp cloth (to avoid burned-on cleanser residue) and wipe dry. Do not use your dish towel or sponge to wipe off the cook top. This may leave a film of detergent or other matter that can cause discoloration the next time the cook top is heated.

Avoid abrasive scouring powders of any kind. Also, avoid using plastic, nylon or metal cleaning pads. They may scratch or melt onto the cook top. Avoid chemical cleaners such as chlorine bleach, ammonia, hydrochloric acid or chemical oven cleaners. They may etch or discolor the surface.

Do not let anything that melts such as plastics, aluminum foil, or sugar to come in contact with your cook top surface when it is hot. Should something melt onto the surface, immediately move it to a cool area of your cook top with a razor blade scraper, and then remove it from the cook top as soon as possible.

NOTICE

NEVER CLEAN PLASTIC SURFACES WITH
A DRY CLOTH OR GLASS CLEANING
SOLUTIONS CONTAINING AMMONIA.
NEVER USE SOLVENTS
OR WIPE WITH ABRASIVES.



SPOTLIGHT

The spotlight lens should be wiped with a clean, dry soft cloth to remove any debris such as bugs, salt spray or general dirt. Read the manufacturer's literature for more information.

STAINLESS STEEL



Stainless steel is an alloy made from nickel, chromium and iron. It has been very successful in marine environments due to its ability to resist rusting. If the stainless steel product such as a bow rail is exposed to elements such as ocean spray it will begin to rust over time.

If your stainless steel shows signs of rusting:

1. Wash with fresh water.
2. Clean with a good quality chrome polish periodically but no less than annually. "Brasso" is another product that works well.
3. Also, using a good quality car wax will provide extra stainless steel protection.
4. For polished finishes that show grit lines an abrasive such as "Scotch Brite" or sand paper can be used. Always test a spot first and "go with the grain".

Do not use harsh solvents or cleaners on stainless steel. Do not use steel wool or wire brushes. They will damage the finish.

Do not use any type of acids.

Cosmetic Care & Maintenance

STAINS

Below is a listing of normal stains and clean-up methods. The sooner the stain is removed there is less chance of permanent residue on the surface.

Do not use wire brushes, solvents or harsh chemicals on any stain. Damage to the surface will occur.

FREQUENT STAINS	CLEAN-UP STEPS		
	1	2	3
Coffee, Tea, Chocolate.....	B		
Permanent Marker*.....	E	B	C
Household Dirt.....	A	B	
Grease.....	D	B	
Ketchup, Tomato Products.....	A	B	
Latex Paint.....	A	B	
Oil Base Paint.....	D	B	
Mustard.....	A	B	C
Suntan Oil.....	A	B	
Asphalt/Road Tar.....	D	B	
Crayon.....	D	B	
Engine Oil.....	B		
Spray Paint.....	B		
Chewing Gum.....	D	A	
Shoe Polish*.....	D	B	
Ballpoint Pen*.....	E	B	A
Lipstick.....	A	B	
Eye Shadow.....	E	B	
Mildew*.....	C	B	A
Wet Leaves *.....	C	B	A

A= Soft brush; warm soapy water/rinse/ dry

B= Fantastik cleaner

C= One tablespoon ammonia, 1/4 cup of hydrogen peroxide, 3/4 cup of warm water/ rinse/dry

D= Scrape off residue (use ice to lift gum)

E= Denatured alcohol/rinse/dry

* These products contain dyes which leave permanent stains.



UPHOLSTERY

Cockpit vinyl requires periodic cleaning to maintain a neat appearance and to prevent the build up of dirt and contaminants that may stain and reduce the vinyl life if they are not removed. The frequency of cleaning depends on the amount of use and conditions to which the vinyl is subjected.

Most common stains can be cleaned using warm, soapy water and clear rinses. Scrubbing with a soft bristle brush will help loosen soiled material from embossed surfaces and under welting. If the stains are not removed with the above method use a mild cleaner such as Fantastic. This cleaner should be used only as needed and not the normal means.

With more stubborn stains, rubbing alcohol or mineral spirits may be tried cautiously. Widespread solvent use can severely damage or discolor vinyl.

Try to remove stains immediately before they have a chance to penetrate the surface of the vinyl.

Powdered abrasives, steel wool, or industrial strength cleaners are not recommended for cleaning our vinyl. Lacquer solvents will cause immediate damage. Dilute chlorine bleach before using. Do not wax the vinyl as it may cause cracking. Always wear protective gloves and make sure there is sufficient ventilation when cleaning vinyl. Wear eye protection.

Remember that suntan oil will damage vinyl. Use suntan lotion instead of suntan oil. Exposure to the sun is a natural enemy of vinyl upholstery. For maximum life, use a cockpit cover when the vessel is moored, docked or stored.

Cosmetic Care & Maintenance

Ballpoint Pen Removal Instructions

1. Wipe the stain off with ethanol (rubbing alcohol).
2. Prepare a solution of 50% non-chlorinated bleach, 50% water.
3. Place a thin line of tissue over the ink stain.
4. Apply the non-chlorinated bleach solution to the tissue. Be sure not to saturate the tissue.
5. Cover tissue with polyethylene film (plastic wrap) to prevent the non-chlorinated bleach solution from drying.
6. Check on stain repeatedly.
7. Do not leave the non-chlorinated beach solution on for more than 1 hour.
When the stain looks almost gone, remove the tissue and wash the stain with water.
9. To neutralize the bleached area, place tissues on the bleached area and apply 15% hydrogen peroxide solution.
10. Leave on for 30 minutes, & then remove the tissues.
11. Remove the peroxide residue with water.



MAINTENANCE

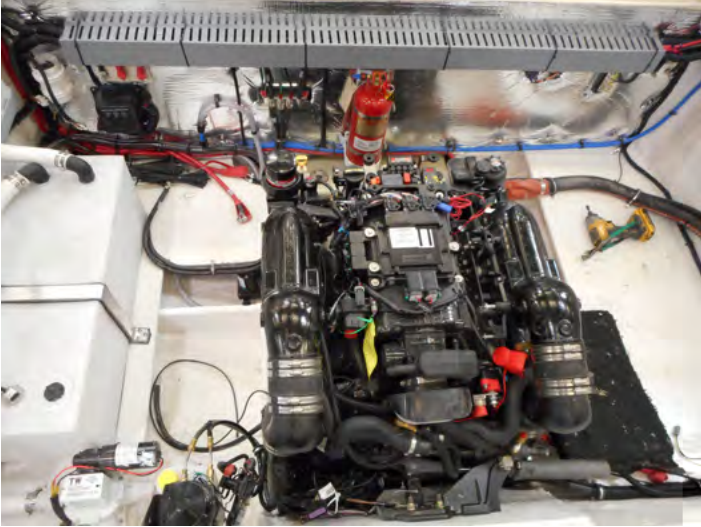

This section covers maintenance procedures on selected standard and optional Regal installed and/or related equipment. *Engine and propulsion equipment, electronic and specific entertainment components are found by referring individual vendor information located in the owner's information packet.*

The engine and propulsion owner's manual are quite detailed and should be read and understood before attempting to undertake any maintenance issues. **Heed special attention to all caution, warning and danger labels found in the engine/propulsion and generator manual.** Also, the major electronic and entertainment components are outfitted with detailed system descriptions, wiring schematics, and contact information. The internet can be helpful for select maintenance issues. Numerous web-sites are currently available from vendors on their particular product maintenance procedures and schedules.

Cosmetic Care & Maintenance

AIR CONDITIONER:

Before each outing inspect the thru-hull fitting for leaks. Make sure the seacock is open. Also, the sea water strainers located under the engine room center walk-thru should be checked periodically for foreign objects and accumulated debris. To clean the strainer, first position the seacock handle to the “off” position. Unscrew the strainer fasteners by turning counterclockwise, remove the wire strainer, and blow it out if possible with compressed air. Reinstall the strainer, make sure the gasket on the top of the seacock is centered, and tighten the fasteners. Check for leaks since sucking air into the system could cause the seawater pump to malfunction. See the illustration.

Inspect the air filter monthly. The air conditioner filter is located at the condensation unit at both forward and aft A/C units. To clean the filter remove it and rinse with plenty of fresh water. Blow with compressed air as needed.

Check the AC hose output located on the hull side for a full discharge when the AC pump is running. If there is little or no discharge shut down the unit and immediately find the cause of the problem.

Periodically check the drain located at the compressor to make sure the entrance to the hose at the AC pan is not clogged with foreign matter.

If clogging occurs, blow out the hose with compressed air and pour in a bleach/water solution at 5/1 parts water to bleach.

Be sure to read and understand the A/C owner’s manual before attempting any maintenance. It covers the operating system and equipment more thoroughly than can be done here. Pay close attention to all safety labels since both high pressure and high voltage are part of the A/C system.

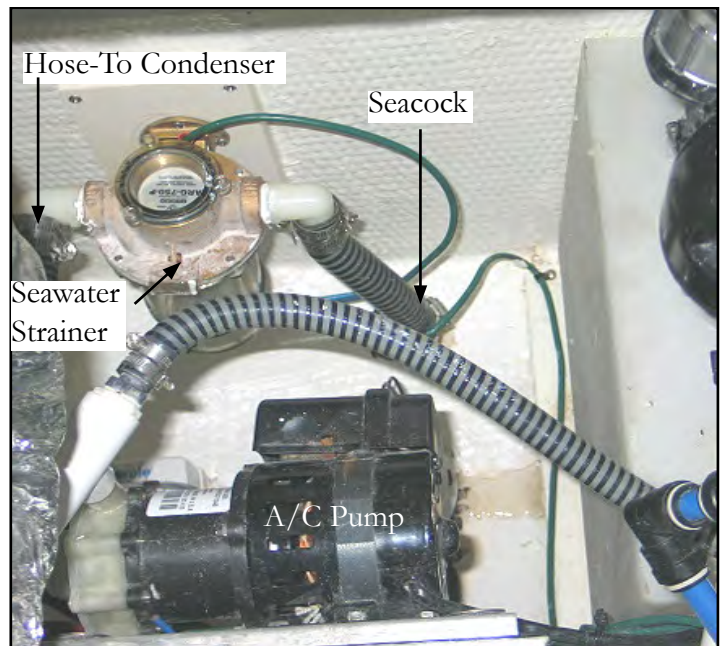

TYPICAL COMPONENTS SHOWN

 **WARNING**

TO PREVENT BODILY INJURY OR DEATH!
DISCONNECT THE A/C BREAKER AT THE
MAIN A/C PANEL BEFORE OPENING ANY
COVER ON THE A/C UNIT.

 **WARNING**

TO PREVENT BODILY INJURY OR DEATH!
DUE TO THE HIGHLY PRESSURIZED
REFRIGERANT FOUND IN THE AIR
CONDITIONER UNIT, DO NOT LOOSEN
OR REMOVE ANY FITTINGS.

REVERSING VALVES

All reverse cycle units use a reversing valve: the valve must be energized periodically to keep the internal parts moving freely. To do this, switch the AC unit into heat for a few seconds once a month.

SEAWATER STRAINER

Check the AC pump for proper seawater flow by cleaning the seacock strainer basket. Check the overboard discharge for proper water flow. Check seawater intake speed scoop for obstructions. Make sure hoses are not looped, kinked or crushed.



TYPICAL VECTOR COMPACT AC SYSTEM

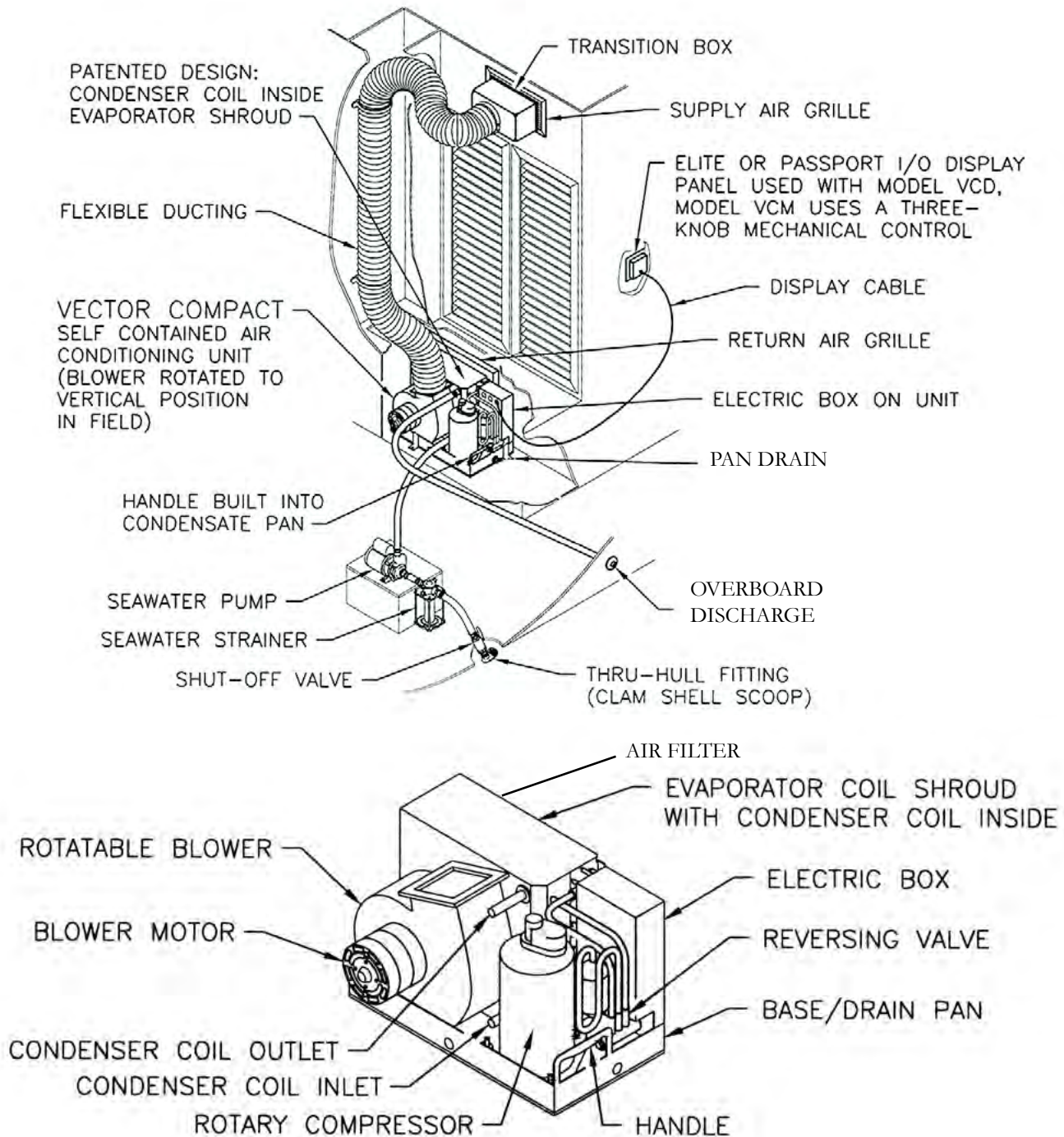

Cosmetic Care & Maintenance

CONDENSER COIL CLEANING

Note: It is best to get an air conditioning expert familiar with marine a/c to do the periodic maintenance mentioned below. The information will assist the technician.

1. With the system turned off at the ship's AC electrical panel, disconnect the inlet and outlet connections of the condenser coil.
2. Use chemical resistant hoses (MAS white PVC 5/8" I.D., etc.) to connect the inlet of the condenser coil to the outlet of a chemical resistant, submersible pump (MAS P-500 pump, etc.) and let the hose connected to the coil outlet flow freely into the container mentioned below.
3. Place a strainer or piece of screen over the inlet of the pump and submerge the pump into a container filled with a 5% solution of muratic or hydrochloric acid and fresh water or use a premixed over-the-counter solution. Use as large a container as possible to hold the solution (2 to 5 gallons).



CAUTION

AVOID BODILY INJURY!
AVOID SPILLING OR SPLASHING
THE SOLUTION.
FOLLOW THE WARNINGS
AND RECOMMENDATIONS GIVEN
BY THE MANUFACTURER
OF ANY ACIDS
OR PREMIXED SOLUTIONS.

4. Power the pump and circulate the solution through the condenser coil for 15-45 minutes depending on the size of the coils and the extent of the contamination. Visual inspection of the solution in the container should indicate when the contamination removal has stopped.

5. Circulate fresh water through the coil to flush any residual acid from the system.
6. Restart the system and check operational parameters to ensure thorough cleaning has taken place. Additional cleaning may be necessary with extreme contamination.

NOTICE

FOR THE PURPOSE OF PROTECTING
THE ENVIRONMENT,
DISPOSE OF ANY CONTAMINATED
ACID SOLUTIONS IN ACCORDANCE WITH
FEDERAL, STATE AND/OR LOCAL
REGULATIONS

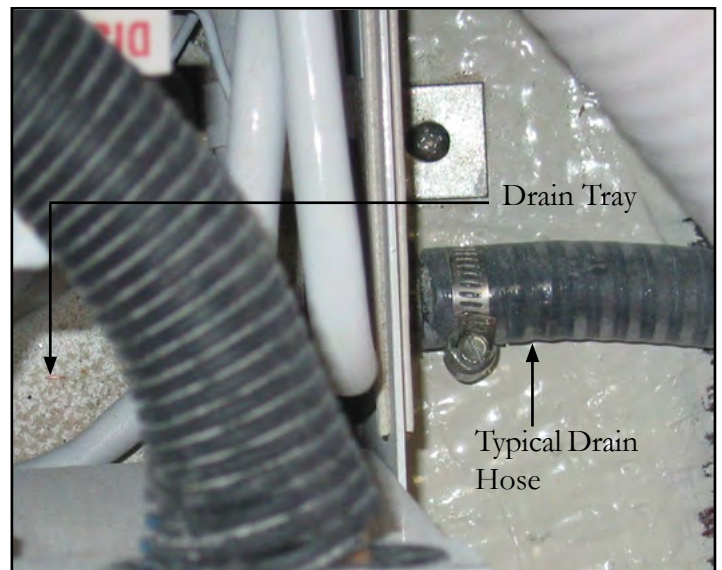

AIR FILTERS

Check the air filter located at both A/C condensation units monthly and clean as necessary. To clean the filter, remove it from the unit, rinse with water, air dry and reinstall. Blow with compressed air as needed. See the illustration on the preceding page.



BATTERIES

Periodically check your battery terminals for corrosion build-up. If you find a greenish, powdery substance, remove the cable connections and clean both the terminals and the connectors with a wire brush. When the cleaning is finished reconnect the battery cables and coat the terminals with an approved grease or petroleum jelly to help prevent further corrosion. Check the electrolyte level at least every 30 days, more often in hot weather. The level should be maintained between the top of the battery plates and the bottom of the fill cap opening. Add distilled water only as needed after charging the batteries. Do not overfill because sulfuric acid could run over and cause burns or an explosion. Check specific gravity levels with a hydrometer which can be purchased at auto retail stores.

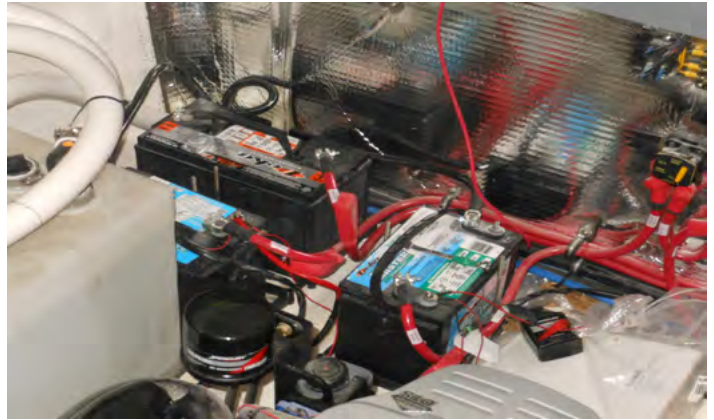

Tighten all battery connectors securely. Check their tightness by pulling on the connectors. They should not move from their tightened position. Be sure to reinstall the positive boot over the battery terminal after tightening the battery post connection. While using the boat, keep an eye on the volt meters to monitor the charge level of each battery bank. Monitor the charge with the engines turned off (static condition).

The engine alternators recharge the batteries. A fully charged battery will indicate between 12 and 14 volts on the voltmeter. Readings below this could indicate a dead battery cell or a charging system malfunction which should be checked by a marine professional.



WARNING

**TO PREVENT BODILY INJURY!
WEAR GOGGLES, RUBBER GLOVES
AND A PROTECTIVE APRON
WHEN WORKING WITH A BATTERY.
BATTERY ELECTROLYTE CAUSES SEVERE
EYE DAMAGE AND SKIN BURNS.
IN CASE OF SPILLAGE,
WASH AREA WITH A SOLUTION OF
BAKING SODA AND WATER.**

Batteries should be charged outside the boat. Do not smoke or bring flames near a battery that is being or has recently been charged. The hydrogen gas generated by battery charging is highly explosive.

Set the batteries on a block of wood not concrete since the batteries will lose their charge if left on a cement surface.

Do not allow a metal object or loose wires to spark across battery posts while working close to the battery. Contact across terminals will cause a short circuit and possible electrical burns, fire, explosion or personal injury.



WARNING

**TO PREVENT BODILY INJURY!
BATTERIES CONTAIN SULFURIC ACID
(POISON)
WHICH ALSO CAN CAUSE BURNS.
AVOID CONTACT WITH THE SKIN,
EYES & CLOTHING.
IF CONTACTED, FLUSH WITH WATER AT
LEAST 15 MINUTES. IF SWALLOWED, DRINK
LARGE AMOUNTS OF WATER OR MILK.
FOLLOW UP WITH MILK OF MAGNESIA,
BEATEN EGG OR VEGETABLE OIL. GET
MEDICAL ATTENTION IMMEDIATELY!**

Cosmetic Care & Maintenance

BATTERY MAINTENANCE

Maintenance Free Type

The Group 31 “maintenance free” engine cranking batteries are not all together maintenance free. Unlike regular batteries there are no fluid levels to maintain on this style battery but several other items need to be monitored periodically.

1. Check both positive and negative terminal hardware for tightness. Loose connections are known to discharge a battery very quickly.

2. Make sure all terminals are clean. If not a battery cleaner tool (available at car parts stores) or old toothbrush should be used to clean both the positive and negative terminals. Use a small amount of baking soda and water. Remove any residue from the terminal area with a disposable damp cloth.

Install corrosion protection to the posts before reinstalling the terminals. Refer to the illustration.

3. After all preventative maintenance is completed slide the red boot back over the positive terminal. This will prevent any object from arcing across the positive terminal to ground possibly causing a fire.

House

The house battery needs periodic post cleaning maintenance for optimum performance. Again, check all fasteners and cable clamps for tightness



Chapter 8

To do a general check on the condition of a battery:

1. Test for an open-cell voltage. Use a dedicated battery tester or a voltmeter.

With the battery fully charged with no circuits energized the voltage across the terminals should be 12.5 to 12.6 volts. If the battery is not completely charged, but still adequate to crank the engine over, you may see a reading closer to 12 volts.

2. If the battery shows less voltage or will not charge up completely it may be time to replace the battery.

3. The maximum voltage you should see across the battery terminals with the engine running as read by a voltmeter well above idle is 14.6 volts. If the reading is over this amount the charging circuit may be supplying too much voltage to the battery reducing the acid levels inside the battery.

3. Check both positive and negative terminal hardware for tightness. Loose connections are known to discharge a battery very quickly.

4. Make sure all terminals are clean. As discussed earlier, a battery cleaner tool along with a toothbrush should be used to clean both the positive and negative terminals. Use a small amount of baking soda and water. Remove any acid residue from the terminal area and battery top with a damp cloth. Be sure to wear plastic gloves and eye protection. See the illustration.

Install an anti-corrosion lubricant to the posts before reinstalling the terminals. This lubricant is available as a paste or spray type and can be found at most marina or auto supply stores.

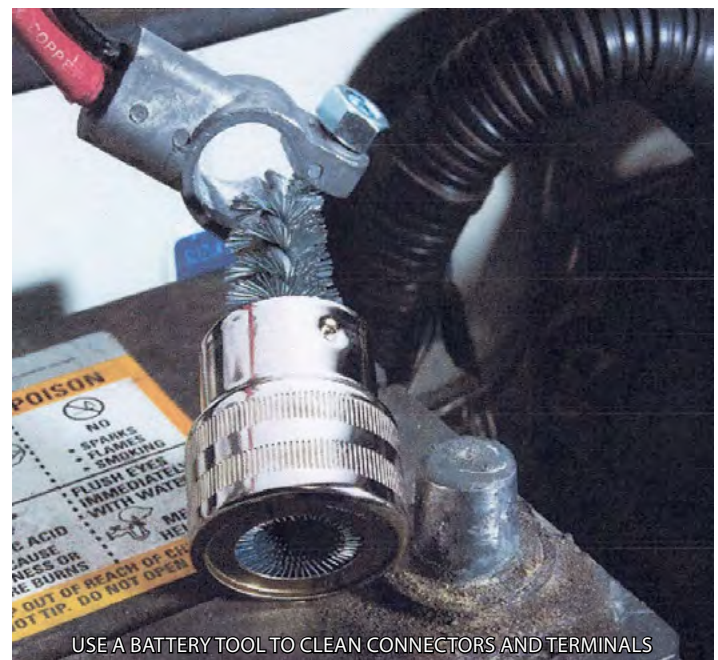

Be sure to reinstall any red (+) battery (anti-short) boots.

Cosmetic Care & Maintenance



CAUTION

AVOID EYE DAMAGE/SKIN BURNS!
WEAR GOGGLES & RUBBER GLOVES
WHEN WORKING WITH BATTERIES.
AVOID CONTACT WITH SKIN,
CLOTHING OR EYES.
IN CASE OF CONTACT,
FLUSH WITH WATER
FOR AT LEAST 15 MINUTES.
IF SWALLOWED,
DRINK LARGE QUANTITIES
OF WATER OR MILK.
FOLLOW WITH MILK OF MAGNESIA,
BEATEN EGG OR VEGETABLE OIL.
GET MEDICAL ATTENTION IMMEDIATELY.



CAUTION

TO PREVENT BATTERY ARCING
FIRST REMOVE THE NEGATIVE BATTERY
CABLE FROM THE BATTERY.



BATTERY SWITCH MANAGEMENT PANEL

If the battery switch (DC distribution panel) should lose power to one of the batteries, check the breakers close to that battery switch. Look for a “popped breaker. The above problem could be recognized by the appropriate icon not being lighted at the DC distribution panel. These breakers protect the charging/battery circuitry. Always find the cause of the overload before resetting the circuit breaker.



Cosmetic Care & Maintenance

TYPICAL BILGE PUMP/FLOAT SWITCH

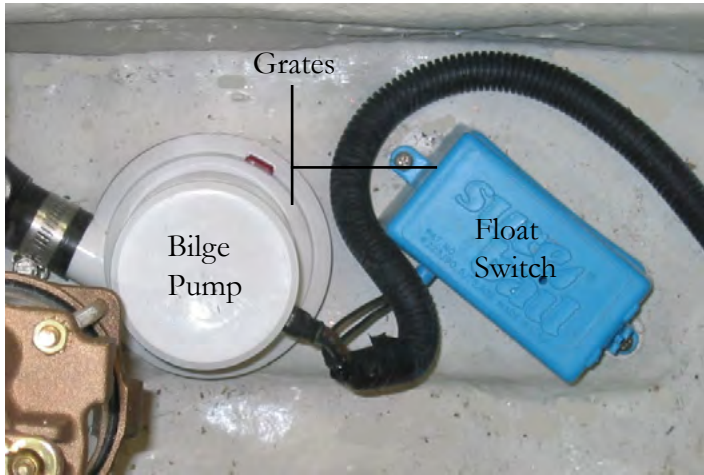

Your vessel offers as standard equipment bilge pump service. Periodically check the grates for debris and test spray the units down with water. Make sure that a steady stream of water exits the through hull fitting indicating the hose from the bilge pump itself is clear. Periodically check all hoses, clamps and electrical connections for tightness.



CARBON MONOXIDE DETECTOR



Use the following procedure **monthly** or when leaving the vessel for extended periods. Normal maintenance should include frequent checking for the green power light glowing with the warning indicator and audible horn off. The detector should be returned to the manufacturer for recertification each year.

CO Sentinel Carbon Monoxide Alarm

TO REMOVE CIRCUIT BOARD FROM BASE PLATE

FOLLOW THESE TWO STEPS:

1. Push "locking pins" outward and lift bottom portion of board toward you.
2. Holding the board with one hand, pull to remove the connector(s).

TO RE-INSTALL: Reverse this procedure.

TO INSTALL CIRCUIT BOARD INTO BASE PLATE, FOLLOW THESE TWO STEPS:

1. Insert top of board (with 45° angles) under holding tabs on base plate.
2. Gently lower bottom until board "snaps" into locking pins.

FIGURE 1



FIGURE 2

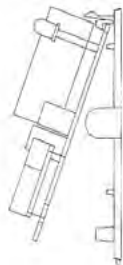

Cosmetic Care & Maintenance

DOOR-CABIN ENTRY

Periodically clean the lower door tracks since debris can clog the track resulting in a door that may jerk instead of slide to open or close. Use a vacuum or a soft damp cloth.

Lubricate the latch and lock mechanism sparingly with a powdered graphite available at the big box stores. Stick the tube in the key hole and squirt in the graphite. Wipe off any excess with a soft cloth.

ELECTRONICS-GARMIN

General Maintenance

Since there are no user-serviceable parts on electronic products they should be serviced only by specific marine electronic certified factory technicians.

Some products generate high voltages, and so never handle the cables/connectors when power is being applied to the equipment.

When powered up, all electrical equipment produces electromagnetic fields. These can cause adjacent pieces of equipment to interact with one another, with a consequent adverse effect on operation. In order to minimize these effects and enable you to get the best possible performance from your electronic equipment, guidelines are given in the installation instructions, to enable you to ensure minimum interaction between different items of equipment, i.e. ensure optimum Electromagnetic Compatibility (EMC).

In some installations, it may not be possible to prevent the equipment from being affected by external influences. In general this will not damage the equipment but it can lead to spurious resetting action, or momentarily may result in faulty operation.

Certain atmospheric conditions may cause condensation to form on the instrument window. This will not harm the instrument and can be cleared up by increasing the illumination setting.

Periodically clean any electronic display screens with a soft damp cloth. Do not use any harsh chemicals, solvents or abrasive materials to clean the instrument.

Note: For detailed information on each component refer to your electronics owner's manuals in the owner's information packet. Also, the vendor can be found on-line or phone your closest Regal yacht dealer.



ELECTRONICS-VHF RADIO



If installed the VHF marine radio has been constructed to be virtually maintenance free. With a little attention to a few basic care points, the unit should provide years of service.

1. Although the unit is waterproof by design, keep it as dry as possible. When cleaning the cockpit, never use a direct water nozzle on the unit.
2. Clean the exterior with a soft, non-abrasive cloth.
3. **Do not use any solvents or other chemicals for cleaning the VHF radio.**
4. Periodically inspect the radio case, electrical wiring and antenna for physical damage.

Note: For further information refer to your electronics owner's manuals in the owner's information packet. Also, the vendor can be contacted on-line or phone your closest Regal dealer.

Cosmetic Care & Maintenance

FIRE EXTINGUISHING SYSTEM-AUTOMATIC



Inspect the pressure gauge before each outing. The illustration shows the ready and discharge condition of the actuator. Remove and weigh the unit (minus brackets) every 6 months on an accurate scale (Do

not use any hand held scales). If weight is below that shown on the unit nameplate, it must be removed from service immediately. If leakage is suspected, brush liquid soap on all points of possible leaks, or submerge entire unit in clean fresh water and watch carefully for 5 or 10 minutes. Leaks will appear as tiny bubbles. If leakage is found return to the factory immediately for repair or replacement. Remember the two most important requirements to assure full charge and reliability of your Fireboy system are:

1. Visual inspection of the gauge and the actuator to determine if it has actuated.
2. Weighing to determine the true contents of the agent in the system.

All models from 75 cubic feet are rechargeable. Recharging is possible only if the unit has leaked out verses losing agent due to a fire.

Should the indicator light fail to come ON when the ignition key is ON, first check the pressure gauge and actuator to see if the unit has discharged. If not check the breaker. Next, using a continuity tester, check the electrical pressure switch on the system bottle itself. Pull the molded rubber connector off by pulling straight away from the manifold, and place the probes of the continuity tester directly on the spade connectors. This pressure switch should show a closed circuit.

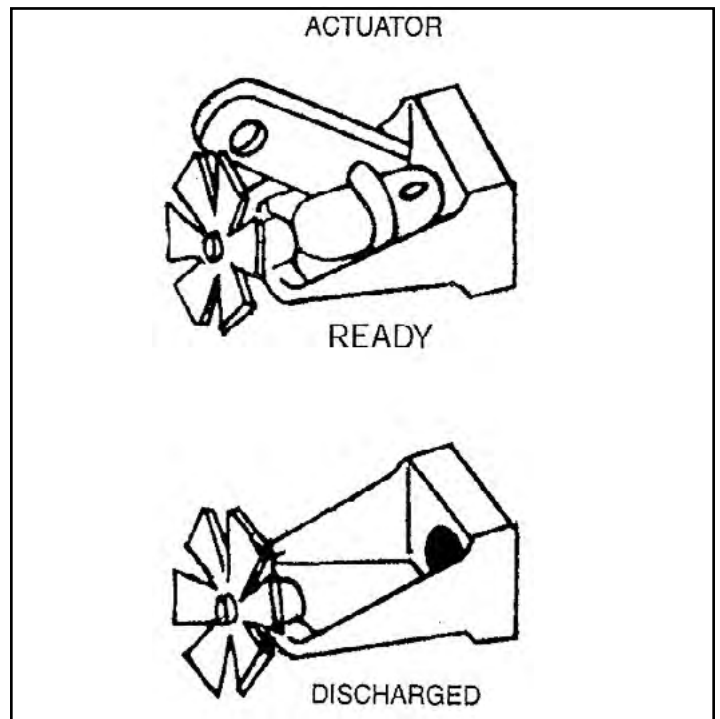

Next, check the continuity of the entire wiring circuit. The indicator lamp is an LED (light emitting diode) and cannot be tested with a continuity tester.

A simple method to test LED'S is to remove the lamp and touch the red wire to the + terminal and the black wire to the - terminal of an ordinary 9 volt battery. Should the indicator lamp be faulty, replacement lamps are available from Fireboy.

Should the continuity of the pressure switch indicate an open circuit, the system will have to be returned to the factory for either replacement or repair.



FUEL SYSTEM

Periodically (at least twice annually) inspect the fuel tank components for loose clamps at the vent, fill, return and feed locations. Examine each hose for signs of deterioration and leakage. Check the fuel sender for loose fasteners and leaks at all areas of contact. Also, inspect the fuel tank for signs of leakage or abrasion. Tighten all components as needed.

Note: Do a visual inspection before each cruise. Again, include the high pressure diesel engine fuel hose components along with the diesel fuel filters both in-line and connected to the engine. Also, with dual fuel tanks check the diesel fuel transfer pump connections.



GROUND FAULT OUTLET:



The GFIC (Ground Fault Interrupter Circuit, GFIC abbreviated) outlets should be tested monthly. To test the unit, depress the reset button. Then press the test button. The reset button should pop out.

If it does not, contact a qualified electrician or marine professional to replace the device.

Refer to Chapter 4 where it explains the system operation and shows the circuitry throughout the

vessel. The GFIC is normally located at the beginning of a circuit so that all receptacles further down the circuit are protected. That could be a reason why several components plugged into outlets will not work when a GFIC is not functioning.

The device trips between 4 and 6 mA's.

Cosmetic Care & Maintenance

HEATER-HOT WATER

A. The most important maintenance factor with the hot water heater is that it is winterized with Winterban (RV anti-freeze; alcohol style) in freezing climates. Use the water heater drain valve to vacate water from the tank. The water will automatically drain into the shower sump pump and then will be sent overboard. *Make sure the water heater breaker is turned off before any winterization is started to prevent the element from being burned out.*

B. If the system is constantly being used in warmer climates it is a good idea to periodically drain the hot water valve for 30 seconds or so to eliminate any scale that has built up inside the hot water heater. Turn the breaker off just as a precaution.

C. The hot water heater and heat exchanger parts are made of aluminum. If engine flushing is required by the manufacturer be sure to disconnect the heat exchanger from the system temporarily.. The caustic chemicals will damage the hot water heater aluminum parts. Re-plumb the heat exchanger back after engine flushing.

D. Test the T& P valve periodically to make sure it works properly. Its purpose is to let off excess water vapor (steam) if the thermostat should stick and a critical temperature situation develops within the tank. Pull on the valve to test it. The water will vacate to the shower sump pump and then overboard.

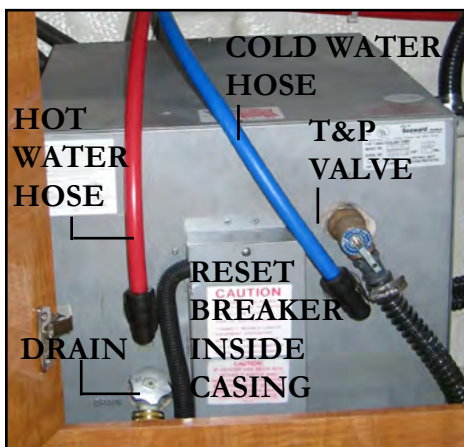



HIGH WATER ALARM

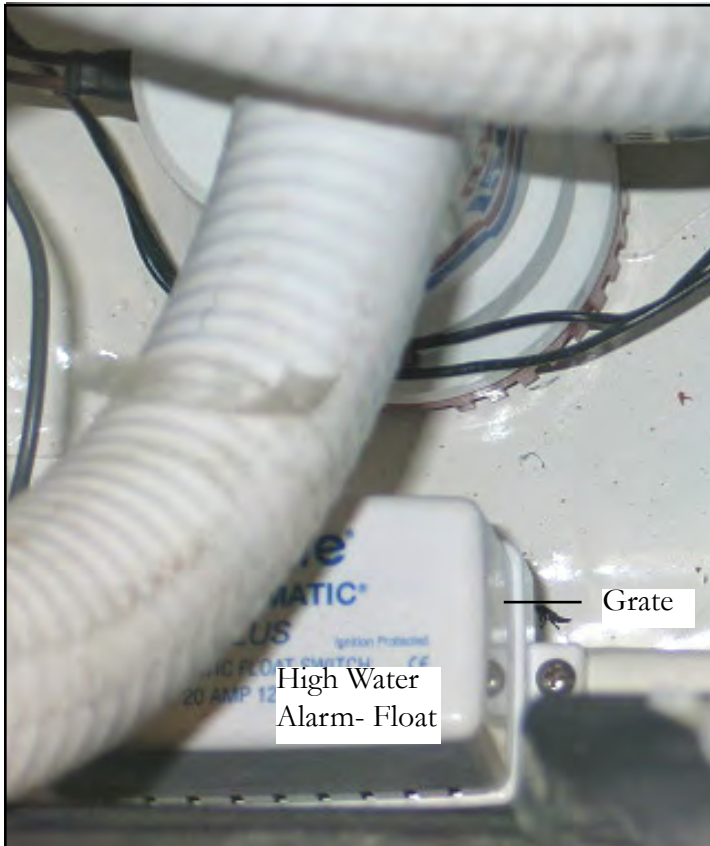

The high water alarm float is located in the engine room. Periodic maintenance consists of visually inspecting the float grate cover for debris and removing any accumulation.



WARNING

TO PREVENT BODILY INJURY OR DEATH
NEVER USE AUTO ANTIFREEZE IN A MARINE
WATER SYSTEM OR ANY OF ITS PARTS.
AUTO ANTI-FREEZE IS HIGHLY TOXIC
AND POISONOUS TO THE HUMAN BODY.

Cosmetic Care & Maintenance

PLUMBING CONNECTORS

Plumbing connections to the red and blue fresh water lines require special instructions when they are to be removed or replaced. Be sure to turn off the water for that circuit at the manifold before starting any plumbing repairs.

1. To remove a tee, 90 degree, or straight connector fitting first remove the cap on the end of the fitting by using a slotted screwdriver. Insert the screwdriver in the cap slot and turn 90 degrees. Cap will release from the fitting.

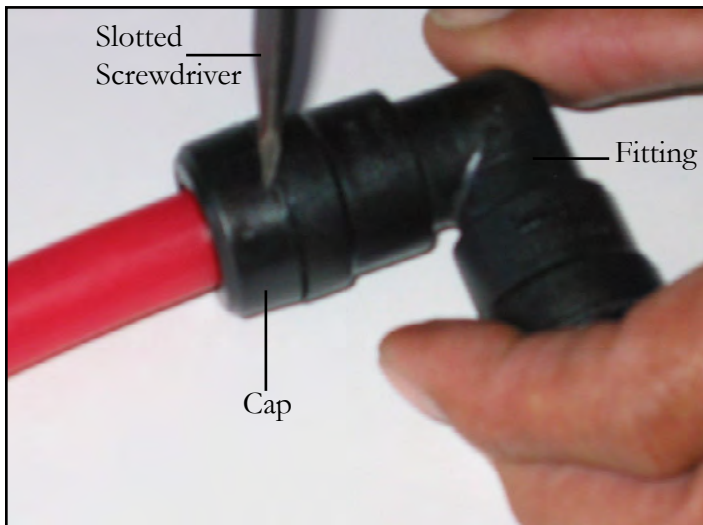

2. Push the connector and collar together. Hold the collar next to the connector with your finger. Pull and the connector/collar will release itself from the water line.

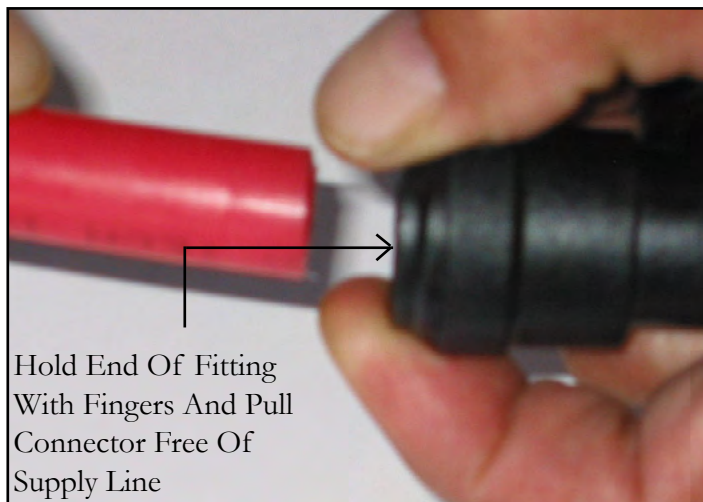

To reinstall a plumbing connection to a water line make sure the line is cut off square and the end is smooth. This will aid in ensuring a leakproof connection.

1. Install the cap on the supply line. You may need to use a slotted screwdriver to remove the cap from a new fitting.

2. Simply push the fitting on to the supply line until pressure is felt. This ensures it is completely in the fitting.

3. Push the cap on the collar until it snaps in place. Turn on the water pressure and check for leaks.

Note: With the connector in place, a movement between the line and connector is normal.



PRESSURE PUMP-FRESH WATER

The fresh water system in general requires very little maintenance.

1. See the equipment operation chapter defining the recommended seasonal disinfection procedure.
2. The fresh water filter needs to be cleaned periodically. Simply remove the hose clamp and unscrew the fresh water filter to access the screen. Rinse the screen off to remove any foreign debris. Be sure to use teflon tape on the pump fitting threads before installing the filter. Reinstall the components and check for leaks.
3. Periodically check all fittings for leaks.
4. In colder climates, use Winterban or its equivalent in all the fresh water system components after draining the system.



Cosmetic Care & Maintenance

PUMP-OVERBOARD DISCHARGE



If your boat is equipped with an overboard discharge pump pay close attention to what materials are flushed through the waste system as it could become clogged. Do not pump garbage, rags, or sanitary napkins through the overboard discharge pump (macerator). Flush the waste tank and pump with fresh water with each pump out. Do not run the pump dry or for extended periods of time since the impeller can be damaged.

Pump the waste system out at decommissioning time and rinse fresh water through the entire system periodically to keep the hoses clean of debris especially the pump out hose.



SHOWER SUMP PUMP-TYPICAL

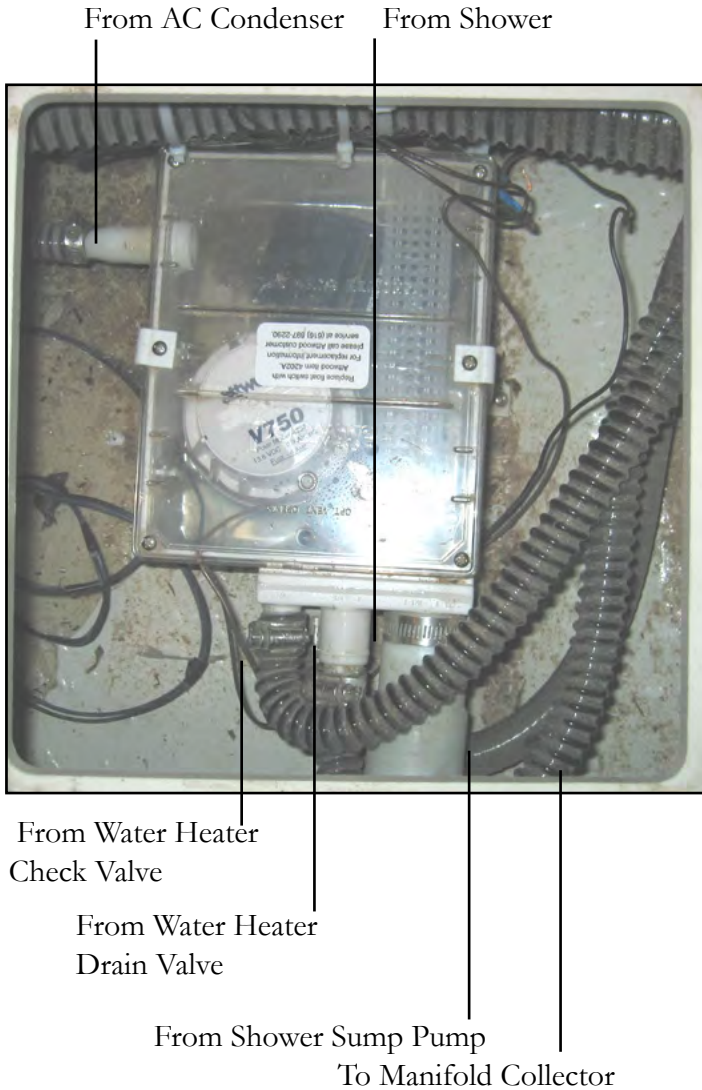

The shower sump pump shown above is used to collect gray water waste from the sinks or the shower itself. After the liquid reaches a designated height, the sump pump energizes through a float switch and exits waste to a manifold then overboard. This system helps to protect our water supply by not dumping used water overboard. Periodically check the sump pump grate for debris such as hair and soap build up. Check to make sure the automatic float operates freely at all times. Also, clean out the box with a bleach/water solution as needed to kill bacteria. You can back flush using the bleach/water procedure.

Cosmetic Care & Maintenance

STEREO/DVD PLAYER/TELEVISION

Since most of the same cleaning and maintenance tips overlap on these entertainment components, they will be grouped together.

1. To clean the CD slots in stereos, built-in DVD players use a dry or slightly water moistened swab to remove any buildup of debris. This monthly procedure will assist in preventing the CD discs from being scratched.
2. To clean the faceplates of the various units use a dry soft cloth. If the faceplate is stained badly, use a moist cloth with a neutral cleaner. Do not use harsh, caustic or alcohol based chemicals to keep the letters from coming off the faceplate. Do not use silicone spray or WD-40 since they could damage mechanical parts.
3. If these units will not play CD's properly it they may have developed condensation. Wait 1 hour and retry.
4. Keep all remote controls out of extreme heat and high moisture environments. Change batteries often for best operation.
5. Periodically check CD discs for scratched and dirty ones. Clean the dirty ones with a cleaning kit which can be purchased at most electronic stores.
6. With flat screen televisions, do not attempt to service the unit yourself since high voltage exists.
7. To clean the flat screen display, dampen a soft cloth with water or a mild detergent. The best cleaner is a screen cleaning tissue specifically designed for antistatic coating. Never use flammable cleaning materials or glass cleaners with ammonia since they attack the television screen surface.



TELEVISION FLAT SCREEN MONITOR

These cleaning recommendations cover LED TV's that may be installed in the main cabin, forward and master staterooms and cockpit. Regular cleaning of these units will help extend their life. Turn the power off at the breaker before you begin any cleaning procedure.

Cleaning The Screen

Wet a soft cloth in a mixture of warm water and fabric softener or dish washing detergent. Wring out the cloth until it is almost dry. Wipe the screen to remove dust and debris.

Remove any excess water from the screen and let the screen air-dry before you activate the television breaker and turn the unit on.

Cleaning The Cabinet

Use a soft, lint-free cloth to clean the cabinet off. Again, do not use a wet cloth.

NOTICE

TO PROTECT THE INTERNAL TELEVISION COMPONENTS OF THE TELEVISION REMOVE THE TELEVISION FROM THE VESSEL IN FREEZING CLIMATES. CONTACT YOUR REGAL DEALER FOR TECHNICAL SERVICE.

Cosmetic Care & Maintenance

TRIM TABS

Trim tabs are located on the outer edges of your yacht transom below the swim platform. All mechanical and electrical connections should be periodically checked for tightness, corrosion, and chafing. If a malfunctioning tab is suspected, run each tab in and out while someone looks at each tab to make sure it is moving up and down the proper distance. **Replace any zinc anodes mounted on trim tabs when at one half their life as determined by size. Check anodes twice a month.**

Check the hydraulic power unit fluid (HPU) level. The pump is located in the bilge (sump) close to the transom. To refill, remove the lexan cover and filler plug. Fill with any type automatic transmission fluid (ATF). The fluid level should be 2" from the reservoir bottom.

The trim tabs may be painted for corrosion protection. **Do not paint the anodes** as they protect the tabs from galvanic corrosion.





UNDERWATER HARDWARE-SEACOCKS & STRAINERS

Inspect the thru-hull seacocks before each outing. Make sure the connections between the output hose and the valve are tight. Look for water leaks around the area where the valve and hull meet.

Every 30 days open and close each thru-hull valve several times. This will guard against the valve seizing in the open or closed position. Also, make sure the valve handle is tightly fastened. Secure any loose valve handles.

Before servicing the sea water strainer make sure the appropriate seacock has been closed to prevent water from entering the boat. If possible blow out the strainer basket with compressed air or use a metal type brush to remove any accumulated material from the screening material.

Check all parts for wear and possible leaks including any O ring surfaces. Lubricate O-ring with waterproof product available at many box or pool stores. Do not overtighten the strainer hold down fastener which could cause strainer body damage especially on the newer plastic versions. Use original replacement marine parts only. After all parts are reassembled open the seacock and check for leaks.

Notice there is a drain hole in the bottom of the strainer body.

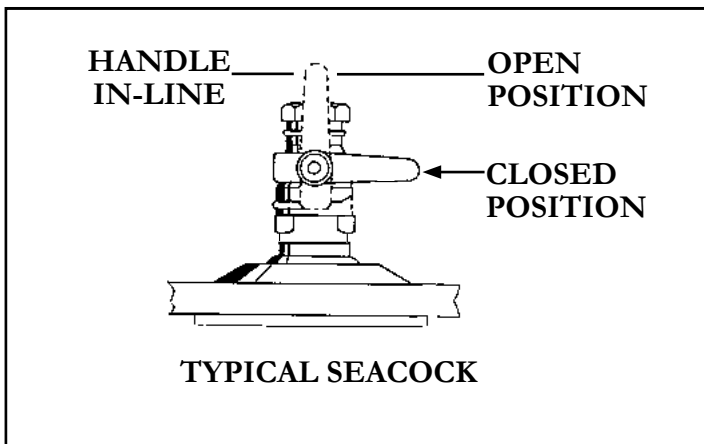

TYPICAL STRAINER

Cosmetic Care & Maintenance

TOILET-VACUUM DESIGN

Vacuum style toilet systems need to be cleaned periodically for maximum sanitation and operational efficiency. Clean the bowl with a cleaner such as Bon Ami which will not abrade the toilet bowl lining. Do not use chlorine solvents or caustic chemicals such as drain openers because the various system seals may be damaged.

Use the following procedure **monthly** or when leaving the vessel for extended periods.

1. Fill bowl with water.
2. Add 1 cup of biodegradable powdered laundry detergent.
3. Flush toilet by pressing the pedal for about 2 minutes. Release foot pedal to close flush ball.
4. Most marinas offer a service that uses a vacuum hose connected to the deck waste fitting that pulls the waste from the tank. We suggest using a hose after the process and shoot a few bursts of fresh water down the waste fitting at the deck. This helps the residue left from the pump-out process from building up in the waste hose.

If an odor is apparent from the system try the following:

1. Clean the system out using the above procedure.
2. Check to see that the vent from the holding tank to thru-hull fitting is not clogged.
3. Periodically add the correct holding tank deodorant either Secure or Sealand liquid.
4. Annually replace the in-line vent waste filter normally located in the bilge. This filter can be ordered from a Regal dealer or your local marine supply store.
5. Refer to the toilet manual for further information.

THRUSTER-BOW

Refer to your thruster operator's manual for more detailed information on maintenance schedules and procedures.

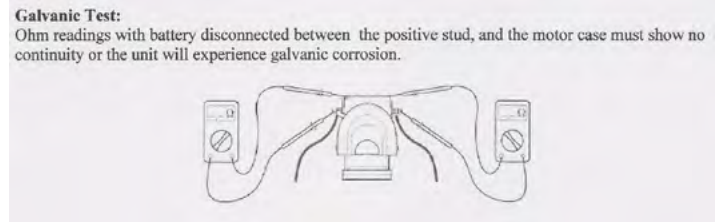

Periodically check the propeller hardware paying close attention to the anode. If anode is 50% eroded replace it. Assemble propeller in this order; large washer, propeller, anode, small washer and nyloc nut. Torque propeller nut to 7.4 foot pounds. Make sure the propeller does not touch tunnel.

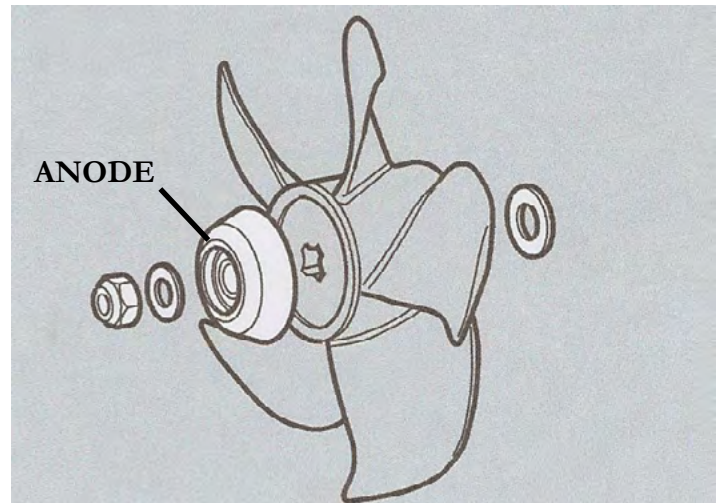



WINDLASS

The typical windlass needs periodic maintenance to keep it in top running condition. Every 6 months the manufacturer recommends that the unit be disassembled and all the above deck parts be washed down with fresh water. Lightly oil (SAE 10) the seal, shaft, cone clutch and spline. Ensure that the base, below the gipsy, is cleaned well and the sealing ring is checked. Grease the threads on the chain pipe cover and stripper screws before re-assembly. The bearing is self lubricating and should not require servicing.

Below the deck check regularly the condition of the motor/gear box and terminals and re-apply grease when necessary. The motor/gear box is two part epoxy painted to protect it against corrosion as it is constructed of steel and lives in the harshest environment on your craft. If corrosion on the motor is evident, clean and repaint with marine grade oil based enamel paint.

Note: Refer to the windlass operator's manual for additional and more detailed maintenance information.



	WARNING
TO PREVENT BODILY INJURY REMOVE THE CHAIN FROM WINDLASS BEFORE PERFORMING MAINTENANCE.	

Troubleshooting

DIAGNOSTIC CHARTS

The following diagnostic charts will assist you in identifying minor electrical, electronic, fuel, and mechanical problems associated with selected standard and/or optional components. A portion of the items listed require technical training and tools. Additional up-to-date information is available in the various operation manuals as select items and their troubleshooting techniques may change since the printing of this manual and/or are too numerous to cover in this manual such as electronic components.

Contact your closest Regal dealer, marine professional or internet for further information.

Note: Many times the root cause of a problem can be found using a step by step process of elimination.

 WARNING
AVOID BODILY INJURY AND DEATH! BEFORE PERFORMING ANY MAINTENANCE WORK TURN OFF THE BATTERY SWITCH AND REMOVE THE KEYS FROM THE IGNITION SWITCH.

 CAUTION
TO AVOID BODILY INJURY! USE ONLY APPROVED MARINE REPLACEMENT PARTS.

 CAUTION
TO AVOID BODILY INJURY! SOME EQUIPMENT CONTAINS HIGH VOLTAGE. USE CAUTION WHEN SERVICING ELECTRICAL COMPONENTS.



ELECTRICAL DIAGNOSTICS (AC)

PROBLEM	POSSIBLE CAUSE	POSSIBLE FIX
No AC power	Main shore power breakers tripped or in "off" position	Energize shore power inlet breakers
	Dock power in "off" position	Activate dockside power
	Shore power cord not connected	Plug in shore power cord; twist to lock
	Faulty connection	Repair as needed
	Main ELCI breaker tripped	Repair as needed. Reset breaker.
Nuisance Tripping- Main ELCI	Component causing excessive draw	Repair/Replace part. Reset ELCI
No power to AC outlets and/or equipment	Main AC ship's panel breakers tripped or in "off" position	Reset or activate main breakers
	Shore power cord not connected	Plug in shore power cord
	GFCI tripped	Find cause of trip. Reset GFIC
Main ship's breaker continues to trip	Faulty main breaker	Contact yacht authorized dealer
Inadequate AC power with gen-set running	Electrical demand greater than electrical output	Turn off appropriate equipment breakers to lessen load

ELECTRICAL DIAGNOSTICS (DC)

PROBLEM	POSSIBLE CAUSE	POSSIBLE FIX
No DC (12 volt) power	Battery switch in "off" position	Turn selector switch to "on" position,
	Weak or dead battery	Charge or replace battery
Battery not charging (engine running)	Loose belt	Tighten belt
	Faulty alternator	Repair/replace alternator
	Faulty volt meter	Replace volt meter
Battery will not hold charge	Faulty or old battery	Replace battery; use exact replacement
12 volt equipment not working	Equipment switch in "off" position	Switch to "on" position
	Circuit breaker/fuse blown	Reset breaker. Replace fuse.
	Weak or dead battery	Replace battery
	Corroded connection	Eliminate corrosion
	Loose wire	Tighten connection
	Internal equipment short	Replace equipment component



ELECTRONICS-GENERAL

The Garmin electronic packages installed on your boat are very system specific when troubleshooting. Each package is very unique and we could not cover all the systems here. Therefore, refer to the vendor supplied operator's manual for specific troubleshooting information related to an individual electronic component.

In addition, helpful information is readily available on the internet at each vendor site. Information can be downloaded as needed with additional on-line contact and tech services available.

Also, contact your closest Regal dealer where you will find factory trained professionals to assist you in solving more technical electronic component issues.

FRESH WATER DIAGNOSTIC CHART

PROBLEM	POSSIBLE CAUSE	POSSIBLE FIX
Air in water system	Water tank empty	Fill water tank. With pump "on" bleed air from lines until water flows without air.
Fresh water pump cycles on and off	Water system leak	Locate & repair water leak.
No water at sink faucet	Breaker blown	Reset breaker
	Water tank empty	Refill water tank
	Switch turned off	Turn switch to "on" position
	Blocked water filter; pinched line	Clear obstruction or straighten line; clean water filter
	Manifold valve turned off	Turn on manifold valve
	Loose or disconnected wire	Check wire connections
Low water pressure	Defective fresh water pump	Replace water pump
Weak pressure at transom shower	Line pinched	Find/Repair pinched line
Water to pump. No output.	Faulty fresh water pump/pressure switch	Replace fresh water pump or pressure switch
Fresh water pump continues to cycle	Defective pump pressure switch	Replace pressure switch



HOT WATER HEATER

PROBLEM	POSSIBLE CAUSE	POTENTIAL SOLUTION	
No water flow from hot system	Check valve is incorrectly orientated	Remove and correctly install the check valve. (Located within part WX1534B)	
	Check valve is blocked	Remove and clear blockage	
	Tempering Valve has failed or is blocked		Remove and test for flow through HOT to MIX, clear blockage
			Clear blockage on outlet from water heater
	Little or no water in system or water heater	Refill fresh water tank(s) and purge air from water heater (Refer to the water heater instructions).	
	Water system is air locked	Purge system following the water heater manufacturer's instructions	
Water pump failure	Fix or replace water pump		
Water flow but no hot water	Water heater is not operating correctly	Check water heater troubleshooting Instructions	
	Tempering Valve has failed or is blocked	Remove and test for flow through HOT to MIX, clear any blockages	
All hot water (not tempered)	Check valve on cold feed failure	Replace the check valve or clear blockage	
	Tempering valve failure	See 'Failure of tempering valve' below	
Water temperature varying excessively	Heavy draws of either hot or cold water elsewhere in the system	Do not use heavy draw systems or outlets at the same time	
	Unbalanced pressures	Install balancing pressure devices such as expansion tanks or throttling valves. Contact Whale Support for more information	
Hot water backing into cold system	Hot water pressure overriding cold pressure	Check valves faulty or missing	
Cannot adjust to desired water temperature	Unequal pressure	Install balancing pressure devices such as expansion tanks or throttling valves	
	Undersized plumbing system	Ensure all pipe work is correctly sized to allow required volume of water flow	
Insufficient hot water during peak demand	Water heater capacity undersized	Install larger water heater	
	Large air gap in water heater	Purge water heater of air by following the water heater manufacturer's instructions	
	Insufficient time has been allowed for water to heat up	Consult water heater instructions or supplier for heat up time	
Failure of tempering valve	System has been exposed to extremely high water temperature	Check water heater controls are functioning correctly	
	Corrosive water conditions	Incorrect system flush or winterizing chemicals used	
	Mineral deposits	Clean and maintain the build up by regularly flushing the system or using a water softener	
	Electrolysis		Electronically grounding the water heater and system
		Install anode in water heater if not installed, if installed change regularly	



PERFORMANCE DIAGNOSTICS

PROBLEM	POSSIBLE CAUSE	POSSIBLE FIX
Excessive vibration	Material obstructing propeller	Reverse engines to remove material
	Bent drive propeller shaft	Call authorized Regal dealer
	Bent propeller blade	Repair/replace propeller
	Noisy drive bearing	Repair drive unit
	Damaged drive casting	Replace damaged casting
Poor performance	Trim incorrect	Adjust trim
	Unbalanced load	Adjust load
	Engine problem	Call authorized Regal dealer
Engine speed/rpm is low	Growth on hull	Hoist vessel; clean bottom
	Poor quality fuel	Call authorized Regal dealer
	Accumulation of bilge water	Check for leaks
	Trim tab in "up" position	Check trim tab functions/pump fluid levels

REFRIGERATOR DIAGNOSTIC CHART

PROBLEM	POSSIBLE CAUSE	POSSIBLE FIX
Refrigerator not cold	Compressor will not start	Turn breaker on at the main ship's service panel
	Thermostat set too high or on/off switch is in the off position	Reset thermostat or activate on-off switch
	Compressor starts but does not cool fridge	Contact repair professional
	Door latch not closing or door seal not seated	Adjust latch or replace seal
	Condenser dirty	Remove fridge/clean coils with brush or vacuum
Not running on DC	Check for defective thermostat or converter, low battery	Replace thermostat, converter or battery
Not running on AC	Inadequate input voltage	Make sure proper voltage exists on ship's main AC panel.



STEREO DIAGNOSTIC CHART

TROUBLESHOOTING

Problem	Solution
General	
The unit does not respond to key presses.	<ul style="list-style-type: none"> Reset the unit by pressing the Reset button inside the control panel door. 
What is the best way to prevent corrosion on my 700 Series chrome finish?	As with all products exposed to the harsh marine environment, a little care will help to preserve the finish. FUSION recommends that you clean any salt water and/or salt residue from the front panel with a damp cloth soaked in fresh water.

Problem	Solution
SiriusXM	
When I press the tuner source button the SiriusXM screen is not displayed.	Ensure you have the MS700i Tuner region set to 'USA'. Press Menu > Settings > Tuner region > and select 'USA'. <ul style="list-style-type: none"> Ensure the SiriusXM module is plugged into the MS700i. Unplug the SiriusXM module and check the pins in the SiriusXM plug are not damaged.
SiriusXM message: 'Check Tuner'	<ul style="list-style-type: none"> Ensure the SiriusXM module is plugged into the MS700i. Ensure the SiriusXM cable has not been damaged.
SiriusXM message: 'Check Antenna'	<ul style="list-style-type: none"> Ensure the antenna is plugged into the SiriusXM Tuner module. Ensure the antenna is not damaged. Ensure the antenna cable has not been damaged
SiriusXM message: 'No Signal'.	<ul style="list-style-type: none"> Ensure the antenna is not damaged. Ensure the antenna has a clear view of the sky and is not obscured. Ensure the antenna cable has not been damaged
SiriusXM message: 'Channel xx Not Available'	A SiriusXM message informing you that the current channel is unavailable. Possible causes are SiriusXM has removed the channel or your SiriusXM subscription has changed. <ul style="list-style-type: none"> Contact SiriusXM to update your subscription. Online: Go to www.siriusxm.com/subscriptions Phone: Call 1-866-635-2349

STEREO DIAGNOSTIC CHART

SiriusXM message: 'Channel xx Unsubscribed'	<ul style="list-style-type: none"> • Contact SiriusXM to update your subscription. • Online: Go to www.siriusxm.com/subscriptions • Phone: Call 1-866-635-2349
SiriusXM message: 'Subscription Updated'	<p>A SiriusXM message informing you that you have either been granted access to or unsubscribed from various channels.</p> <p>For more information about your subscription:</p> <ul style="list-style-type: none"> • Online: Go to www.siriusxm.com/subscriptions • Phone: Call 1-866-635-2349

Problem	Solution
iPod	
Why does my FUSION Head unit keep locking up when connected to my iPod/iPhone?	<p>If you are experiencing software lock-ups or your unit freezes:</p> <ul style="list-style-type: none"> • Reset the Head unit by pressing the reset button inside the face plate. • Reset your iPod/iPhone (see Apple website from model-specific information). This should resume normal operation. • Make sure you have the latest version of iTunes and the latest operating software in your iPod/iPhone. It is important to update software when Apple releases new versions. If you are connected via a dock, ensure you are using the correct sleeve and the connection to the Head unit is secure.
Will my iPod/iPhone connect to my FUSION product if the battery is flat?	<p>No. It will take a number of minutes for the Apple product to get a minimum level of charge before it can connect and become operational. Please connect and wait for the unit to initialise.</p>
My Apple Device has gone into thermal protection	<p>Caution: The internal dock temperature of the MS-IP700i will be slightly higher than the ambient temperature outside the head unit. Should your Apple iPhone or iPod shut down due to exceeding the operating temperature please carefully remove it from the MS-IP700i and allow it to cool down before using again. Using your Apple device in a low charged state will increase the heat generated whilst it is charging. For more information relating to this please follow the Apple support web site link below. http://support.apple.com/kb/ht2101</p>



STEREO DIAGNOSTIC CHART

<p>My iPod/iPhone will not connect to the Head unit while in the dock.</p>	<p>If your Head unit displays “Not Connected” while using iPod as input source:</p> <ul style="list-style-type: none"> • Check that you are using the correct sleeve combination. If you have the incorrect sleeve combination this could prevent the iPod connector from mating correctly. It could also damage the connector in the dock or your iPod/iPhone itself. If you are uncertain which iPod model you have, go to http://www.apple.com/support/ to get the correct model information for your iPod and sleeve. If you are still unable to connect once you know for certain you have the correct iPod/iPhone–sleeve combination: • Ensure that you have the latest version of operating software installed in your iPod/iPhone and the latest iTunes version. To do this, connect your iPod/iPhone to iTunes and it will check and, if necessary, prompt you to download the latest version. If you are still unable to connect once you have confirmed that you have the latest software or you have updated your iPod/iPhone: • Reset the iPod/iPhone (see the user manual for your Apple product) and also reset the Head unit (see FUSION user manual). If you are still unable to connect: • Contact your FUSION dealer or contact FUSION via the tech email on the FUSION website.
---	---

Problem	Solution
Wireless Remote App for iPad and iPhone	
<p>My FUSION-Link Wireless application displays “No stereo available”</p>	<p>The first thing to check is that you are connected to the correct wireless network for the 700 Series. Once you have confirmed this close the App on the device and restart it (consult the manufacturers website for instructions on restarting) . If this fails check that you have a valid IP address on the 700 Series and follow the instructions in the below tech support item</p>
<p>My FUSION-Link Wireless remote application will not connect to my 700 Series stereo</p>	<p>The first thing to check is that the 700 Series is displaying a valid IP address on the about screen. Select the settings menu then about to confirm. If the display is “ IPNone “ the router is either not a compatible DHCP product or not configured correctly. If the IP address starts with the prefix 169. it is not valid, this is a default address when the router is not sending a DHCP generated IP address or is configured incorrectly. Please review the Router’s instruction manual or contact the manufacturers website for technical help.</p>

TELEVISION DIAGNOSTIC CHART

PROBLEM	POSSIBLE CAUSE	POSSIBLE FIX
Screen is black. Power indicator is off.	TV breaker not activated	Activate TV breaker on ship's main service AC panel.
	TV and/or DVD not turned on.	Activate TV or DVD player.
TV signal weak.	TV antenna breaker not activated or wrong antenna breaker in use.	Activate TV antenna breaker. Check antenna switch for proper signal button.
Image too light or dark.	Brightness or contrast improperly adjusted.	Readjust brightness or contrast to owner's manual specifications.
Horizontal bars appear to flicker, jitter, or shimmer on the image.	Fine function not adjusted properly.	Adjust fine function to owner's manual specifications.
Vertical bars appear to flicker, jitter or shimmer on the image.	Coarse function not adjusted properly.	Adjust coarse function. Then adjust fine function.
Screen is blank and power indicator light is steady amber or blinks every 1/2 or 1 second.	Power management system being used.	See power saver in owner's manual.
Image not centered on screen	Horizontal or vertical adjustments off.	Readjust horizontal or vertical controls.



TOILET (ELECTRIC) DIAGNOSTIC CHART

PROBLEM	CAUSE	ACTION/SOLUTION
Toilet does not flush or flush performance is poor	Waste tank is full (tank indicator light on wall switch is RED) Clog at pump inlet Solid object in macerator Low voltage	Empty waste tank before continuing to use toilet. Override full tank lock-out may cause waste tank to overflow Clear clog Call Tecma at (800-521-3032) Check for no more than 10% decrease in voltage when macerator is running. If voltage decreases more than this there may be wiring problem
Water does not enter bowl during flush or water add cycle	Water supply line kinked or not connected No power to water pump Water supply has been turned off Electronic control problem	Check that supply line is properly connected to fresh water supply. Check for kinks in water supply line Check that circuit breaker has not tripped, check all pump electrical connectors Check water supply valve at manifold Call Tecma at (800-521-3032)
Water level in bowl has changed after flush	Flush refill mode has been changed	Reprogram flush refill mode; see Tecma owner's manual
Water continues dripping briefly into bowl after flush cycle is complete	Toilet is installed below water line with vacuum breaker in water supply line	Normal operation; if only a small amount drips from the nozzle
Bowl drains dry after flush	Water is siphoning out of the bowl	Discharge hose from macerator pump bent. Straighten hose
Wall switch does not appear to light up or does not stay lit	No power to toilet Wall switch not properly connected to toilet Wall switch has entered sleep mode	Check that breaker is not tripped. Check electrical connectors are mated Ensure wall switch electrical connector is fully engaged at controller Wall switch enters sleep mode after 8 hours of continuous inactivity but remains functional. No action needed
	Wall switch electronics problem	Call Tecma at (800-521-3032)
Toilet is inoperative and there is no lighting in the wall switch	No power to toilet	Check that breaker is not tripped. Ensure all electrical connectors are mated. Call Tecma.

THRUSTER-BOW

<p>Fault</p> <ul style="list-style-type: none"> • Thrust in wrong direction? 	<p>Action</p> <ul style="list-style-type: none"> • Change contactor wires on motor solenoid (See section 2.1).
<p>Fault</p> <ul style="list-style-type: none"> • Fuse keeps blowing? 	<p>Action</p> <ul style="list-style-type: none"> • Wrong fuse fitted - check rating and replace. • Propeller restricted or jammed causing excessive load on motor - check and clear. Check that propeller washer is fitted see Section 6.
<p>Fault</p> <ul style="list-style-type: none"> • Control Panel does not illuminate? 	<p>Check</p> <ul style="list-style-type: none"> • Power - Hold ⏻ for 1 second. • Battery is connected. • Main switch ON, check fuse. • Control loom connections. • Long operation has tripped thermal switch. Wait 20 minutes for motor to cool and reset. <p>DO NOT attempt to cool motor by any other means.</p>
<p>Fault</p> <ul style="list-style-type: none"> • Control panel illuminates but no thrust? 	<p>Action</p> <ul style="list-style-type: none"> • Are batteries charged? • Check main motor connections are tight.
<p>Fault</p> <ul style="list-style-type: none"> • Poor thrust or thrust in one direction only?? 	<p>Action</p> <ul style="list-style-type: none"> • Batteries not large enough or charged, cables not recommended size. Voltage at motor when running should be a minimum 10 V for 12 V and 21 V for 24 V units. • Blockage in tunnel/propeller jammed with debris, switch off main power, inspect and clear. • Propeller washers fitted wrong. See Sec.1.6 • Check motor brush springs are located properly, brushes should have good contact with the commutator.
<p>Fault</p> <ul style="list-style-type: none"> • 140TT and 185TT ONLY - Motor turns but no drive? 	<p>Action</p> <ul style="list-style-type: none"> • DO NOT continue to run thruster. • Shear pin broken, remove 4 motor bolts, see Sec. 4.2, drive out old pin and replace with new pin. • Propeller blades broken. Replace with new.
<p>Fault</p> <ul style="list-style-type: none"> • Thruster noisy and vibrating? 	<p>Action</p> <ul style="list-style-type: none"> • Check propeller is not touching the tunnel wall. • 140 - 185 models: Check hub height is correct, see section 7.



TYPICAL WINDLASS

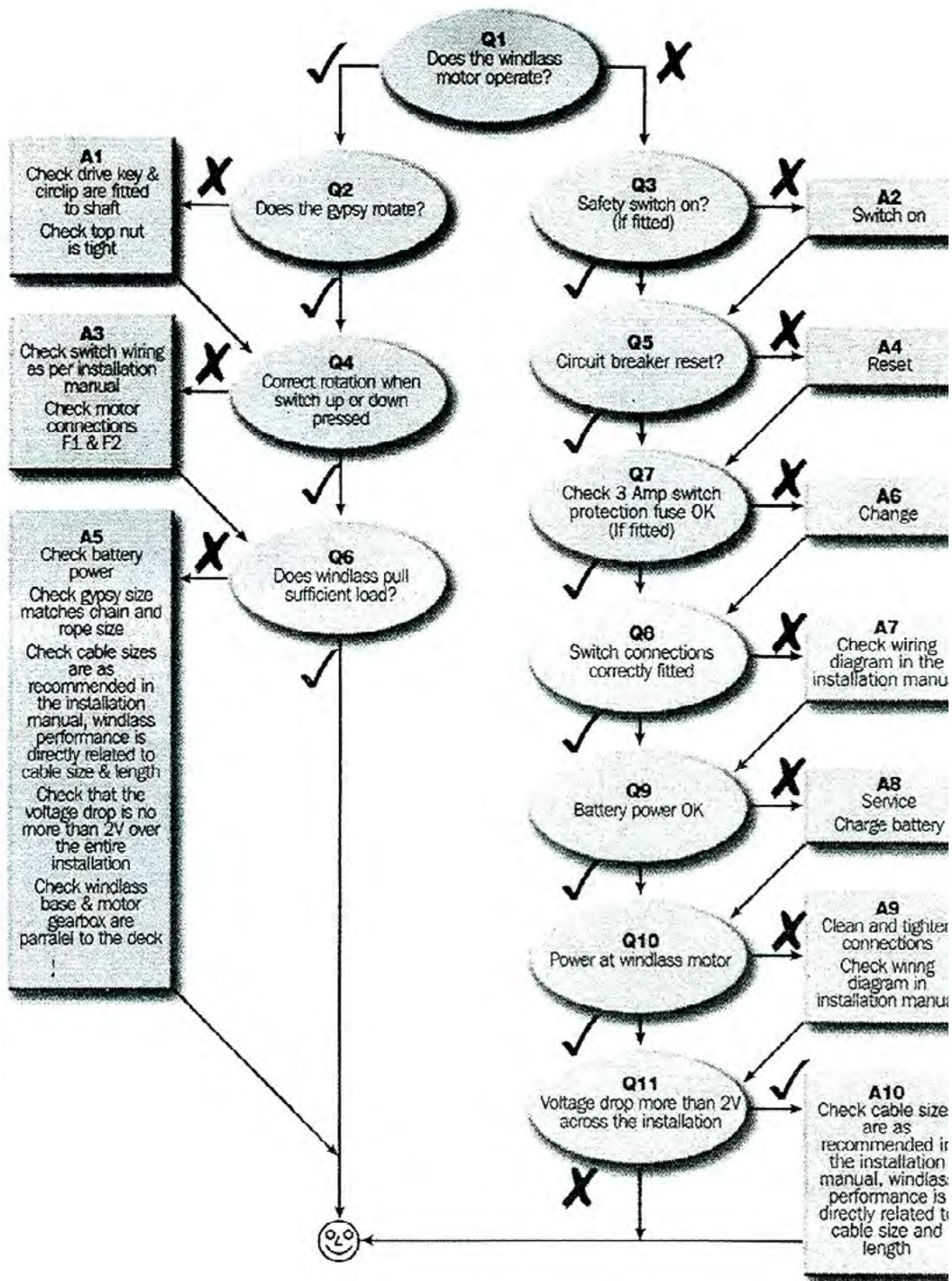

Storage & Winterization

NOTICE

YOUR WARRANTY DOES NOT COVER DAMAGE TO YOUR BOAT IF IT IS NOT PROPERLY STORED AND WINTERIZED. CHECK WITH A REGAL DEALER OR MARINE PROFESSIONAL ABOUT WINTERIZATION PROCEDURES.

NOTICE

REMOVE ALL BATTERIES WHEN VESSEL IS STORED FOR EXTENDED PERIODS.



WARNING

EXPLOSION, FIRE & POLLUTION HAZARD!
DO NOT FILL FUEL TANK TO RATED CAPACITY.
LEAVE ROOM FOR EXPANSION.

INTRODUCTION



Storage procedures are outlined in this chapter. These are general guidelines to follow in colder climates. Be sure to familiarize yourself with all relevant information in the owner's packet.

Special winterization procedures are necessary for the boat equipment and systems. Use the enclosed checklists to help you identify areas of concern and maintenance. These lists cover land stored boats either inside or outside.

All in all, it is best to contact your closest Regal dealer or marine professional for winterization information. They possess the advanced service know how needed to tackle the more complex yacht systems.



DECOMMISSIONING CHECKLIST

BOAT

- Check hull bottom for any fiberglass damage. Repair as needed.
- Apply a coat of wax to hull and deck surfaces.
- Pour a pint of 50/50 antifreeze into bilge pump.
- Remove batteries. Trickle charge over extended periods. Do not set batteries on cement. Use wood blocks.
- Remove all loose gear from boat such as life jackets, etc. Inspect and store in cool, dry environment.
- Remove drain plug. Clean drain plug hole of debris as needed. Enclose drain plug in plastic bag and tie to steering wheel.
- Drain the waste system per instructions in this chapter. Make sure bow is higher than stern to permit proper drainage.
- Clean all upholstery and store so it breathes.
- Conduct a visual inspection to ensure boat is balanced properly. Bow should sit slightly up especially if outside.
- Cover boat with tarp. Tie down for wind protection if outside. Prop tarp up as needed to provide proper ventilation. Be sure not to cover up the fuel vents.
- Drain the fresh water system per instructions in this chapter. (Ensure that the system has been disinfected)
- Send in appropriate equipment for calibration such as the automatic fire extinguisher canister or CO detectors.
- Never use blocking to support the hull bottom as structural hull damage may occur to the vessel which is not covered under the warranty.**

ENGINES

The propulsion systems on your boat are complex in scope. In colder climates, it is recommended that your Regal dealer winterize your boat's engine. Regal dealers have undergone extensive factory training covering the Regal product line. Also, the dealer is equipped with the parts and tools to perform a care free winterization procedure.

- Run engine. Pour a fuel stabilizer/conditioner in the fuel tank. Allow time for it to circulate through the fuel system. Top off fuel tanks to help prevent condensation.
- Change all engine fluids as referenced in the engine manufacturer's owners manual.
- Drain cooling and exhaust system or have a marine professional "pickle" the engine with antifreeze and rust preventative.
- Spray all exterior parts with a rust preventative.

Storage & Winterization

GENERAL NOTES ON ANTIFREEZE

Engine cooling fluids must be replaced with a marine antifreeze solution; mix antifreeze according to directions for the lowest expected temperature. The above method is much more reliable than just draining the engines and manifolds because sometimes pockets of water can form which can freeze in cold temperatures and cause engine damage. Draining the system fosters rust in engine parts. Historically, antifreeze was originally made with methanol. It was because of its chemical nature to escape into the atmosphere and a high corrosion factor on engine metals that it was replaced.

Today, ethylene glycol is used in auto and marine engine applications because of its positive thermal properties. On the downside ethylene glycol contains silicate rust inhibitors that can clog up marine heat exchanger surfaces. This is why it is so important to follow the engine manufacturer maintenance schedules which include changing the antifreeze periodically. In addition, the unpleasant odor of antifreeze is caused by totalisator which also contributes to it being environmentally hazardous. **Notwithstanding, ethylene glycol is poisonous to the human body along with animals.** Therefore, it cannot be used in potable marine water systems.

Propylene glycol is considerably less toxic and retail products are labeled as “non-toxic antifreeze”. It is the product of choice for marine water and waste tanks in freezing climates. It is available at marinas, RV dealerships, and retail marine outlets.

NOTICE

USE A SPECIAL NON-TOXIC ANTIFREEZE
IN THE FRESH WATER & WASTE SYSTEM
WHICH IS AVAILABLE AT RV AND
MARINE DEALERS.
DO NOT USE AN AUTOMOTIVE
TYPE ANTIFREEZE.
IT CAN BE HIGHLY
POISONOUS AND CORROSIVE.



AIR CONDITIONING:

There are several methods of winterization; some work better than others. The various methods employed using a 50/50 biodegradable antifreeze/water solution are:

1. Pumping of antifreeze solution into the overboard thru-hull fitting, and discharging through the intake thru-hull fitting.
2. Use of the seawater pump to move antifreeze solution through the system and discharging through the overboard thru-hull fitting. Close the seacock, remove the hose for the strainer outlet, raise the hose above the AC pump (to prevent lose of prime) and pour in antifreeze solution. Pump solution through system. The strainer and hose to seacock will also need to be drained.
3. Use of pressurized air to force water from the intake through the overboard discharge.

Note 1: Any method that causes the antifreeze solution to flow downward is the method of choice. By this means, the antifreeze solution will displace any water trapped and eliminate the possibility of freezing in hidden areas. In addition, since the seawater pump utilizes a magnetically driven impeller, the impeller should be removed from the wet end assembly, wiped with an alcohol solution, and stored in a warm, dry area until commissioning takes place.

Note 2: Close the AC pump seacock before lifting the vessel from the water. Failure to do so may result in a no prime condition when restarting the air conditioning system. This condition could cause pump failure.

BATTERIES:

Remove the batteries and check the electrolyte level. Store in a cool, dry place. Add distilled water as necessary to top off the battery.

Monthly recharging or continuous trickle charging should be done to insure the battery life during storage. Do not store a battery on cement as it may discharge.

FUEL TANK

Fill the fuel tank to minimize condensation but do not overfill. Leave enough space for fuel to expand and add a fuel stabilizer to fuel tank prior to storage following the manufacturer's recommended procedures.

NOTICE

FOR THE PURPOSE OF PROTECTING
THE ENVIRONMENT,
DISPOSE OF ANY CONTAMINATED
ACID SOLUTIONS
IN ACCORDANCE WITH
FEDERAL, STATE AND/OR LOCAL
REGULATIONS.

Storage & Winterization

TELEVISION:

The television manufacturer recommends that the unit be removed from the vessel in freezing climates. To remove the flat screen do the following:

1. Pull out the power plug from the rear of the television.
2. Unscrew the antenna cable.
3. While someone holds the flat screen, remove the screws that hold the television to the bracket.
4. Do not touch the flat screen or push in on it while trying to remove the unit as component damage may result.
5. Remove the television and store at room temperature.



WASTE/TOILET SYSTEM:

1. Pump out waste holding tank, flush the tank with fresh water and pump out again.
2. With non-toxic propylene glycol antifreeze in the fresh water tank, operate head until antifreeze flows into bowl of each head. Allow time between flushes for the vacuum to build up.
3. Operate macerator until antifreeze has a steady flow coming from the discharge fitting. Pour non-toxic propylene glycol antifreeze solution in head and flush head as needed to produce enough flow to winterize the macerator.
4. Leave at least 2 gallons of non-toxic propylene glycol antifreeze solution in the holding tank during storage.

NOTICE

USE A SPECIAL NON-TOXIC ANTIFREEZE
IN THE FRESH WATER & WASTE SYSTEM
WHICH IS AVAILABLE AT RV AND
MARINE DEALERS.
DO NOT USE AN AUTOMOTIVE
TYPE ANTIFREEZE.
IT CAN BE HIGHLY
POISONOUS AND CORROSIVE.

Storage & Winterization

WATER SYSTEM-FRESH

1. Turn on the fresh water pump switch.
2. Open all faucets including transom shower and allow tank to empty.
3. Drain the water heater; shut off water pump switch.
4. Mix nontoxic antifreeze with water in accordance with the manufacturer's recommendations.
5. Pour solution into the fresh water tank.
6. Turn on fresh water pump switch.
7. Open each cold water faucet one by one beginning with the one furthest away from the tank and purge the system until a steady stream flows from the faucet. Then close the faucet.
8. Repeat step 7 for hot water faucets.
9. Shut off water pump switch.
10. Pour a quart of non-toxic antifreeze into shower drain. Run the shower pump until a steady stream flows from the discharge fitting.
11. Leave at least 2 gallons of non-toxic antifreeze solution in the holding tank during storage.



DISINFECTION OF POTABLE WATER SYSTEM

The following information is taken from the Handbook on Sanitation of Vessel Water Points and is available from the public health service publication #274.

It is a good idea to the potable water system when entering long periods of storage or at the beginning of your boating season.

Following is a suggested method in proper order to accomplish system disinfection:

1. Flush entire system completely by permitting potable water to flow through it.
2. Drain system completely.
3. Fill entire system with a chlorine solution having a strength of 100 parts per million, and allow to sit for one hour. Shorter time frames will require more concentrations of chlorine solution. See the chart.

4. Drain chlorine solution from entire system.
5. Flush whole system thoroughly with fresh potable water.
6. Fill system with fresh potable water.

The chart below indicates how much disinfecting agent is needed to make up various quantities of 100 parts per million chlorine solution.

CHLORINE COMPOUND AMOUNTS REQUIRED FOR 100 PARTS PER MILLION SOLUTION			
SOLUTION (GALLONS)	CHLORINATED LIME 25% (OUNCES)	HIGH TEST CALCIUM HYPOCHLORITE 70%	LIQUID SODIUM HYPOCHLORITE 1% (QUARTS)
5	0.3	0.1	0.2
10	0.6	0.2	0.4
15	0.9	0.3	0.6
20	1.2	0.4	0.8
30	1.8	0.6	1.2
50	3.0	1.0	2.0
100	6.0	2.0	4.0

NOTE: Information from this chart taken from Handbook on Sanitation of Vessel Water Points- US Public Health Service Publication No..274 reprinted June 1963

Glossary & Index

Following is a brief list of nautical terms useful in everyday boating experiences and communications. For more detailed glossaries of nautical terminology we recommend you check your local library, the internet or a marine store for boating books.

GLOSSARY

Abeam: at right angles to the fore and aft line and off the boat

Aboard: on or in the boat

Above: the part of the boat on a bavin vessel which is above the interior of the boat

Aft, After: aft is the boat section toward the stern or back of the boat

Amidships: toward the center of the boat from either side to side or rear to front

Beam: the width of a boat at its widest part

Bilge: the lower interior of the hull of the boat

Bitter end: the end of a line also the end of an anchor line

Bow: the front, or forward part of the boat

Bulkhead: the vertical partition or wall of a boat

Cast off: to let go or release

Chine: the line fore and aft formed by the intersection of the side and bottom of the boat

Chock: deck fitting used to secure or guide anchor or tie lines

Cleat: deck fitting with protruding arms around which lines are secured

Cockpit: the seating space used to accommodate passengers

Cuddy: a small cabin in the fore part of the boat

Deck: the open flooring surface on which crew and passengers walk



Chapter 11

Draft: the depth from the waterline of the boat to the lowest part of the boat, which indicates how much water is required to float the boat

Fathom: a measurement of depth; one fathom equals six feet

Fender: a cushion hung from the side of a boat to prevent it from rubbing against a dock or against other boats

Fend off: to push off to avoid sharp contact with dock or other vessel

Fore: the part of the boat toward the bow or front

Freeboard: the height of the top side from the waterline to the deck at its shortest point. (The distance from the sheer or gunwale to the water)

Galley: cooking area

Gunwale: rail or upper edge of the side of the boat

Hatch: an opening in the deck to provide access below

Head: toilet

Hull: the part of the hull from the deck down

IPS: inboard propulsion system by Volvo

Keel: the lowest point of a boat

Knots: a measurement of speed indicating nautical miles per hour

Lee: the side opposite that from which the wind is blowing; the side sheltered from the wind

Leeward: the direction toward which the wind is blowing

PFD: personal flotation device; required for each person aboard

Port: the left side of the boat when facing forward (an easy way to remember the difference between “port” and “starboard” is that both “port” and “left” have four letters)

Shank: the main body of an anchor

Sheer: the curve of the boat’s deck from fore to aft when seen from the side

Starboard: the right side of the boat when facing forward

Stern: the aft end of the boat

Stern drive: an inboard/outboard (IO) unit

Stringer: strengthening integral unit fastened from fore to aft inside the hull and fiberglass encapsulated for added strength: much like the skeleton system of our body

Top off: to fill up a tank

Transom: the vertical part of the stern.

Trim: the boat’s balance when properly loaded

Wake: the path of a boat left astern in the water



Glossary & Index

A		C	
AC Current	78	Cabinet Care	244
AC Current Load Management	78	Canvas	245
	290	Carbon Canister- EPA Fuel System)	57
AC Panel	87	Carbon Monoxide	32
Accidents	37	Carbon Monoxide Detector	35
Air Conditioning	93		208
	261		270
	308	Cardiopulmonary Resuscitation	194
Alcohol Myths & Facts	36	Carpet-Cockpit	247
Antenna- GPS	221	Interior	246
Anti-Freeze	307	Counter Tops	248
Anchoring	192		
B		D	
BBQ	249	Dealer Responsibilities	15
Batteries	61	Decommissioning	306
	264	Depth Gauge	145
	308	Diagnostic Charts (Troubleshooting)	289
Battery Charger	65	Direct Current (DC)	61
Battery Management System	66	Disinfection Process- Water	312
	268	Distress Signals	24
Battery Switches	66	Diver's Flag	39
Battery System Breaker	64	Docking	191
Berth Fwd.- Sleeper Conversion	209	Dock Lines	139
Bilge-Engine Compartment	243	Dockside Power Cords	79
Bilge Pump	269	Dockside Water Inlet	99
Blowers	57	Dockside Pump-Out	106
Breaker Panel- Helm	71	Door (Companionway)	209
Breast Lines	189	Door (Transom)	223
Bridge Clearance	49	Drain Plug	184
		Drawings	Technical



E		G	
ELCI System	83	GFIC	91
Electrical	60		276
	Technical	Galvanic Isolator	86
Electronics:	117	Garbage	30
	271	Gauges/Switch Panels	253
<i>Depth Gauge</i>	292	Gelcoat Maintenance	250
<i>Plotter</i>	145	General Boating Safety	19
	132	Generator- Outboard Only Option	178
	168	Getting Underway	184
<i>Sirius Satellite Radio</i>	271	Glossary	313
VHF Marine Radio	234	Gray Water System	106
Engine- Stern Drive	133		209
Engine- Outboard	134		
	148	H	
Environmental Awareness	153	Hatch- Deck	210
Exhaust	197	Heater-Hot Water	226
	32		277
		Helm- Overview	138
F		High Water Alarm	229
Fabrics-Interior	249	HIN	9
Fenders	188	Horn	27
Fiberglass Maintenance	250	Hull/Deck- Cleaning	254
Fire Extinguishers	23	Hypothermia	195
	224		
	273	I	
Fires	194	Ignition Switch	141
First Aid	194	Index	315
Flooring	252	In-Line Waste Vent Filter	106
Float Plan	11		230
Fresh Water System	97	Instruments (Gauges)	253
	293		295
	311	International Distress Signals	26
Fuel System- Gas	53		
	186	K	
	274	Knots	191
	296		



Glossary & Index

L		R	
Lights	28	Range/Stove	215
	221		255
M		Refrigerator	216
Maintaining PFD'S	23		297
Markers-For Slings	229	RegalVue	169
Mayday	27	Registration Information	14
Microwave	254	Remote Control	149
Minimum Required Equipment	31		156
Monitor Panel	213	Right-Of-Way	41
N			
Navigation Aids	45		
Navigation Light Rules	28		
Navigation Rules	43		
O			
Oil Spills	29		
Overboard Discharge Pump (Macerator)	107		
	230		
	281		
Outboard	153		
Overloading	20		
Owner's Information Packet	8		
Owner Responsibilities	15		
P			
Performance Diagnosis	296		
Personal Flotation Devices	21		
Plastics	255		
Plumbing Connectors	279		
Pollution Regulations	29		
Power Tower	231		
Propellers	296		
Pressure Pump-Fresh Water	233		
	280		



S		U	
Safety Labels	18	Underwater Lighting	241
Seacocks	107	Upholstery	258
	286		
Seat- Helm	220		
Seating Occupancy	353		
	369		
Shorepower Stations	80		
Shower-Transom	235		
Shower Sump Pump	101		
	282		
Sling Locations For Lifting	324		
	378		
Sound Producing Devices	27		
Specifications	349		
	372		
Spotlight	236		
	256		
Spring Line	189		
Stainless Steel	256		
Stains	257		
Stern Line	189		
Steering	152		
	175		
Stereo	119		
	283		
	298		
	289		
Storage	289		
Sunbrella Canvas Cleaning	245		
Swim Ladder	237		
Swim Platform	39		
	238		
Switch Panel- Helm	73		
T		V	
Table- Dinette	219	VHF	27
Technical Drawings	321		133
Technical Information	319		372
Television	283	Ventilation System	136
	284	Vessel Information Sheet	10
	301	Visual Distress Signals	25
	309		
Toilet	105		
	287		
	302		
Thruster	239		
	303		
Towing	193		
Trim Tabs	110		
	285		
Troubleshooting	289		

Technical

TECHNICAL INFORMATION

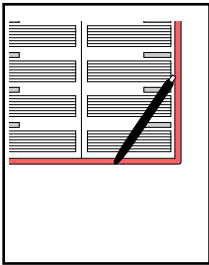

Note that all product specifications, models, standard, optional equipment, systems, along with the technical information is subject to change without notice.

For more information contact your nearest authorized Regal dealer. For the location of your nearest authorized dealer call 407-851-4360

or you can contact Regal through the internet at : **www.regalboats.com**. Your Regal dealer has received special factory training on the entire product line and his services should be employed to solve more technical problems.

Note that many drawings in the following technical chapter are applicable to both the stern drive and outboard models, especially the electrical drawings.

Also, as another option refer to the Yamaha owner's manual for detailed system questions on the outboard engine itself since they are different and unique to the outboard manufacturer especially in the fuel and ignition systems. The manual features a troubleshooting section tailored to the outboard.

A portion of the technical drawings found in this chapter are actual product drawings from the Regal factory. These drawings should be of special interest in mechanical and electrical troubleshooting. The equipment in the drawings is discussed in the various sections of this manual. Understanding specific systems and related drawings will go a long ways in solving problems.



TYPICAL LABEL LOCATIONS (26EX/26XO)

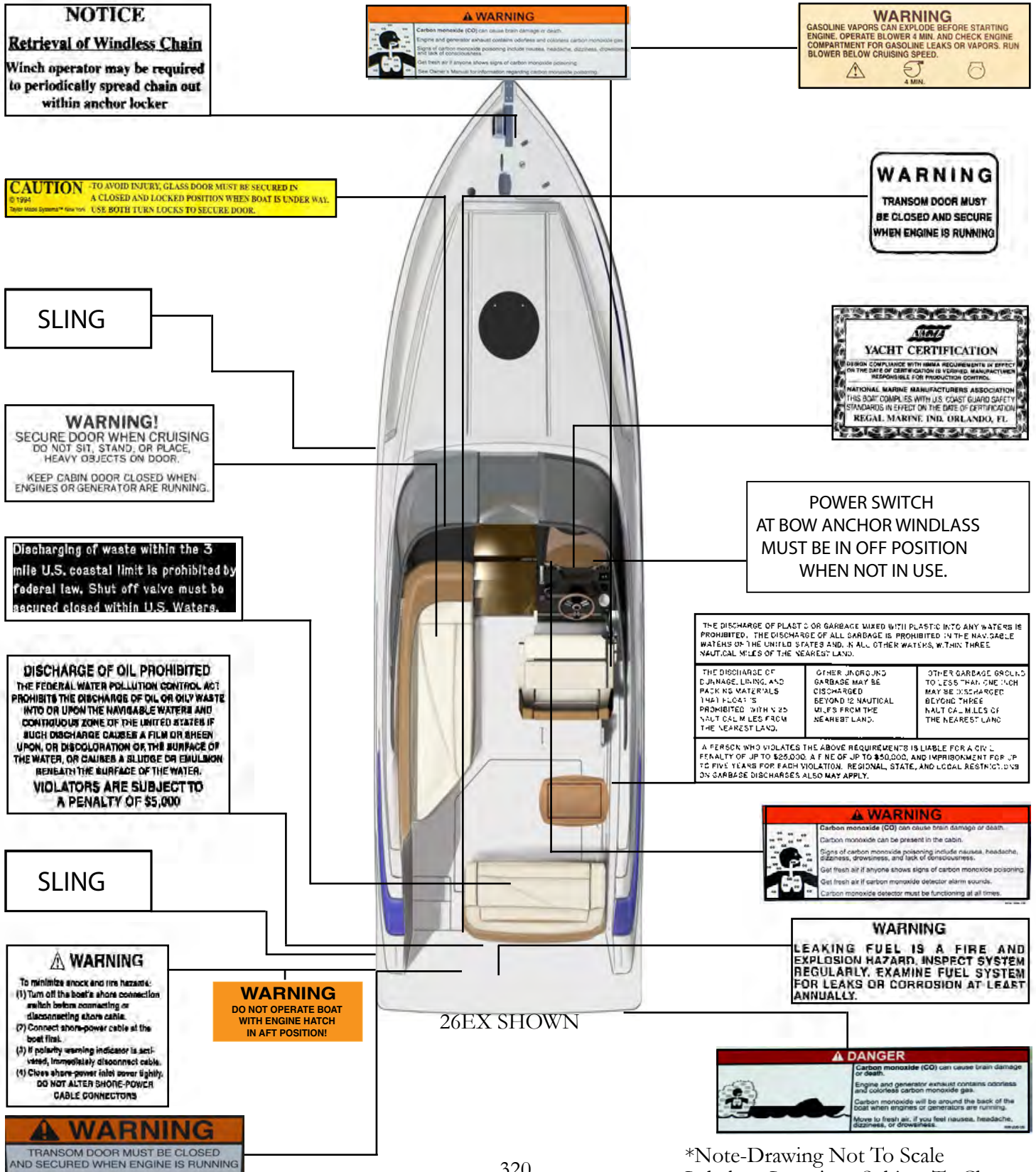

Technical Information

TECHNICAL DRAWINGS

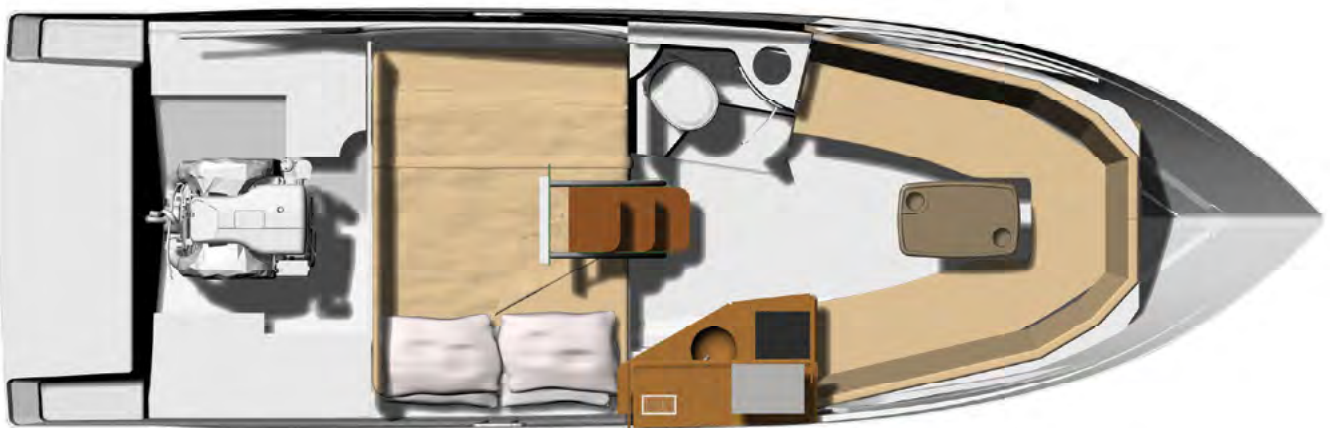

REFERENCE ONLY

PROPRIETARY AND CONFIDENTIAL.
THE INFORMATION CONTAINED IN THIS DRAWING IS THE SOLE PROPERTY OF REGAL MARINE INDUSTRIES. ANY REPRODUCTION IN PART OR AS WHOLE WITHOUT THE WRITTEN PERMISSION OF REGAL MARINE INDUSTRIES IS PROHIBITED.

		
REGAL MARINE INDUSTRIES		
<small>2300 ALPHACON DRIVE ORLANDO, FLORIDA 32809 TEL: (407) 851-4500</small>		
<small>ALL RIGHTS RESERVED</small>		
DRAWING TITLE: 26 Ex General Arrangement		
DATE: 4/8/15	REVISION: -	PAGE: 1 OF 1
DRAWN BY: JAL	APPROVED BY: -	DWG. NO.: 3

26 EXPRESS GENERAL ARRANGEMENT

Technical Information

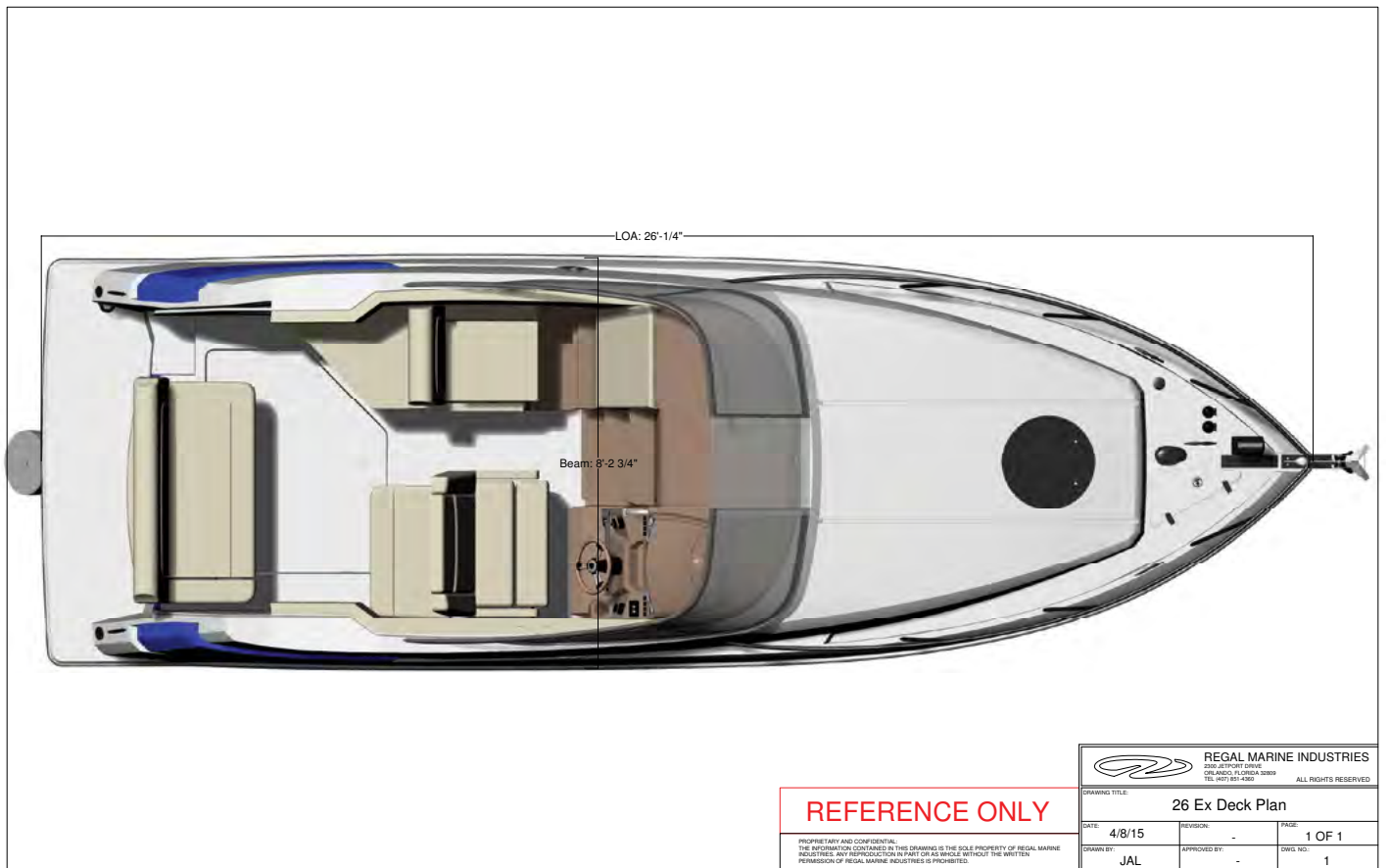

26 EXPRESS DECK FEATURES

Lifting locations are at the bow and stern eyes

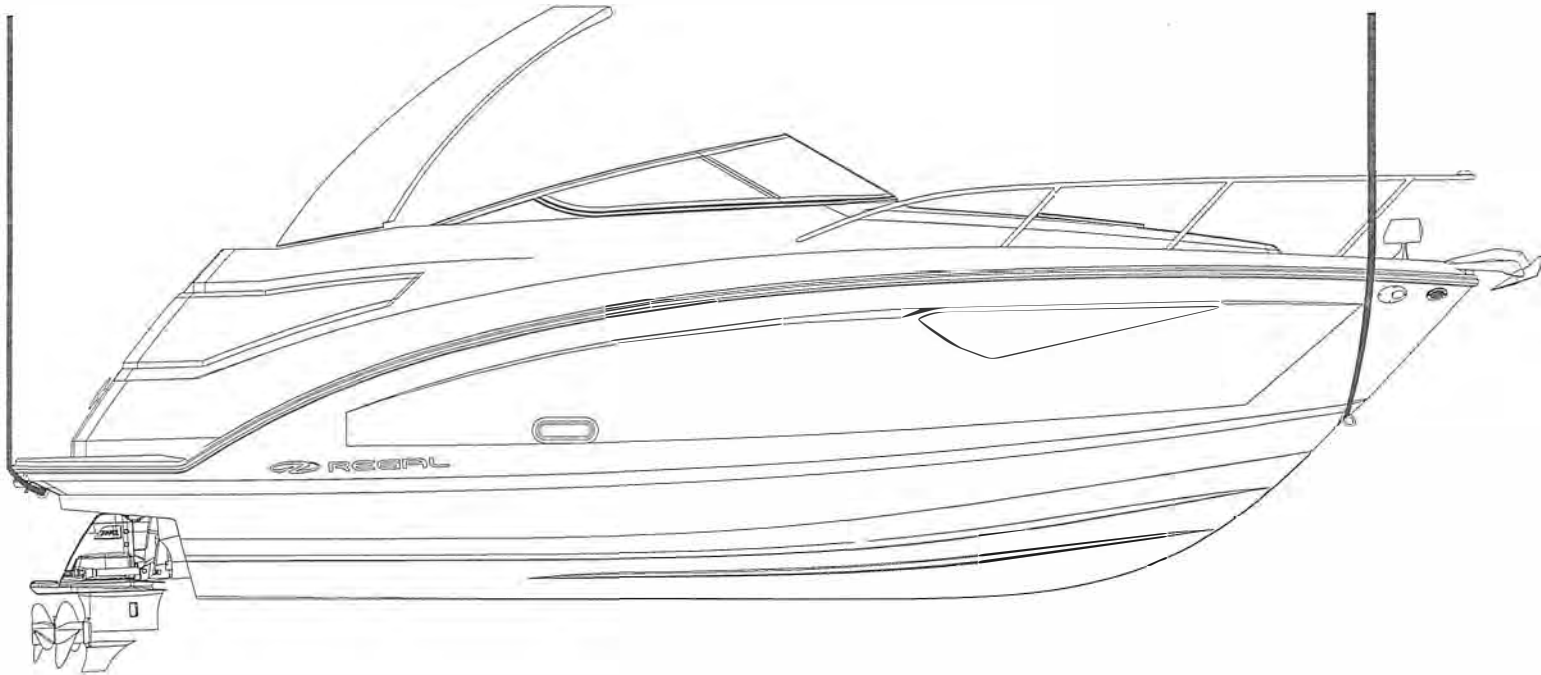

REFERENCE ONLY

PROPRIETARY AND CONFIDENTIAL.
THE INFORMATION CONTAINED IN THIS DRAWING IS THE SOLE PROPERTY OF REGAL MARINE
INDUSTRIES. ANY REPRODUCTION IN PART OR AS WHOLE WITHOUT THE WRITTEN
PERMISSION OF REGAL MARINE INDUSTRIES IS PROHIBITED.

			REGAL MARINE INDUSTRIES	
2350 JEFFERSON DRIVE DADE COUNTY, FLORIDA 33109 TEL: 407-851-4350			ALL RIGHTS RESERVED	
DRAWING TITLE: 26 Ex Sling Locations				
DATE:	4/8/15	REVISION:	-	PAGE: 1 OF 1
DRAWN BY:	JAL	APPROVED BY:	DR	DWG. NO.: 17

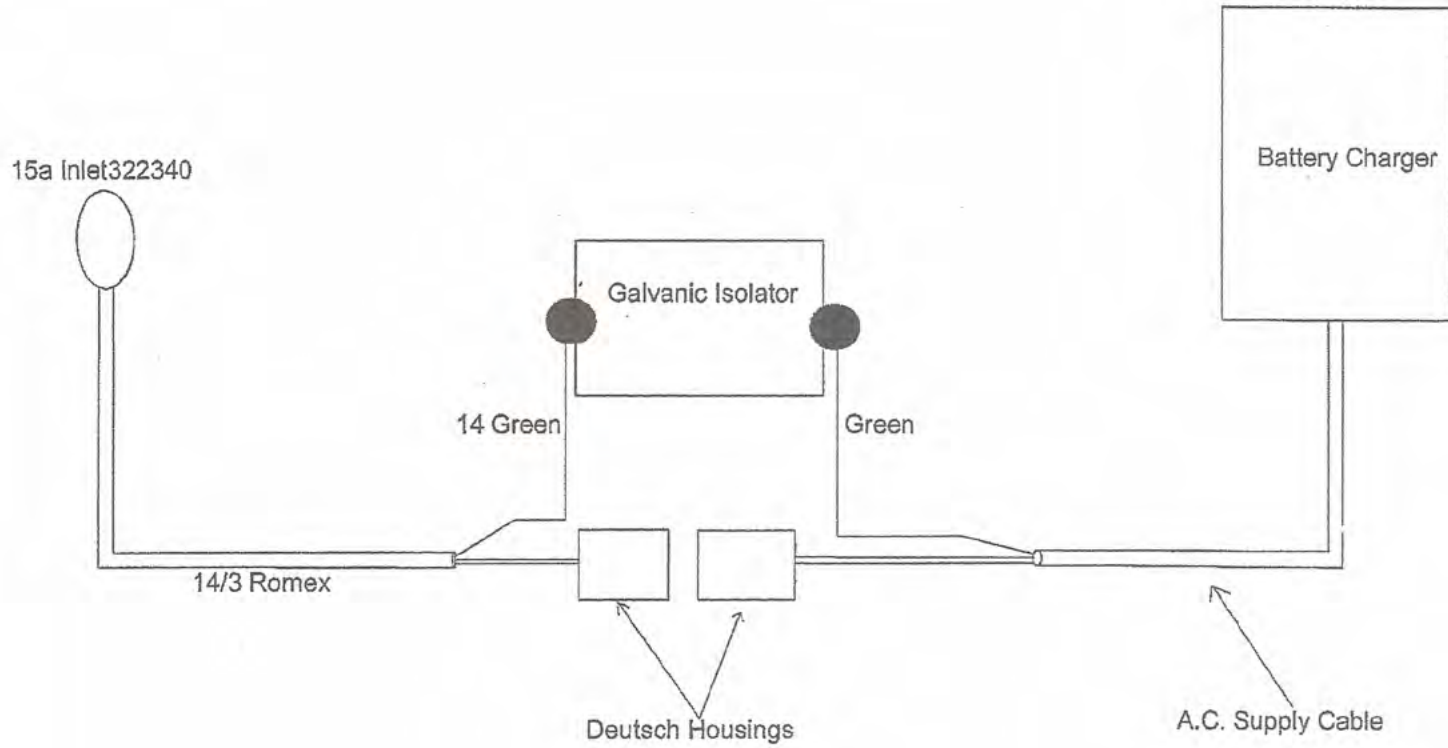

26 EXPRESS GALVANIC ISOLATOR WIRING

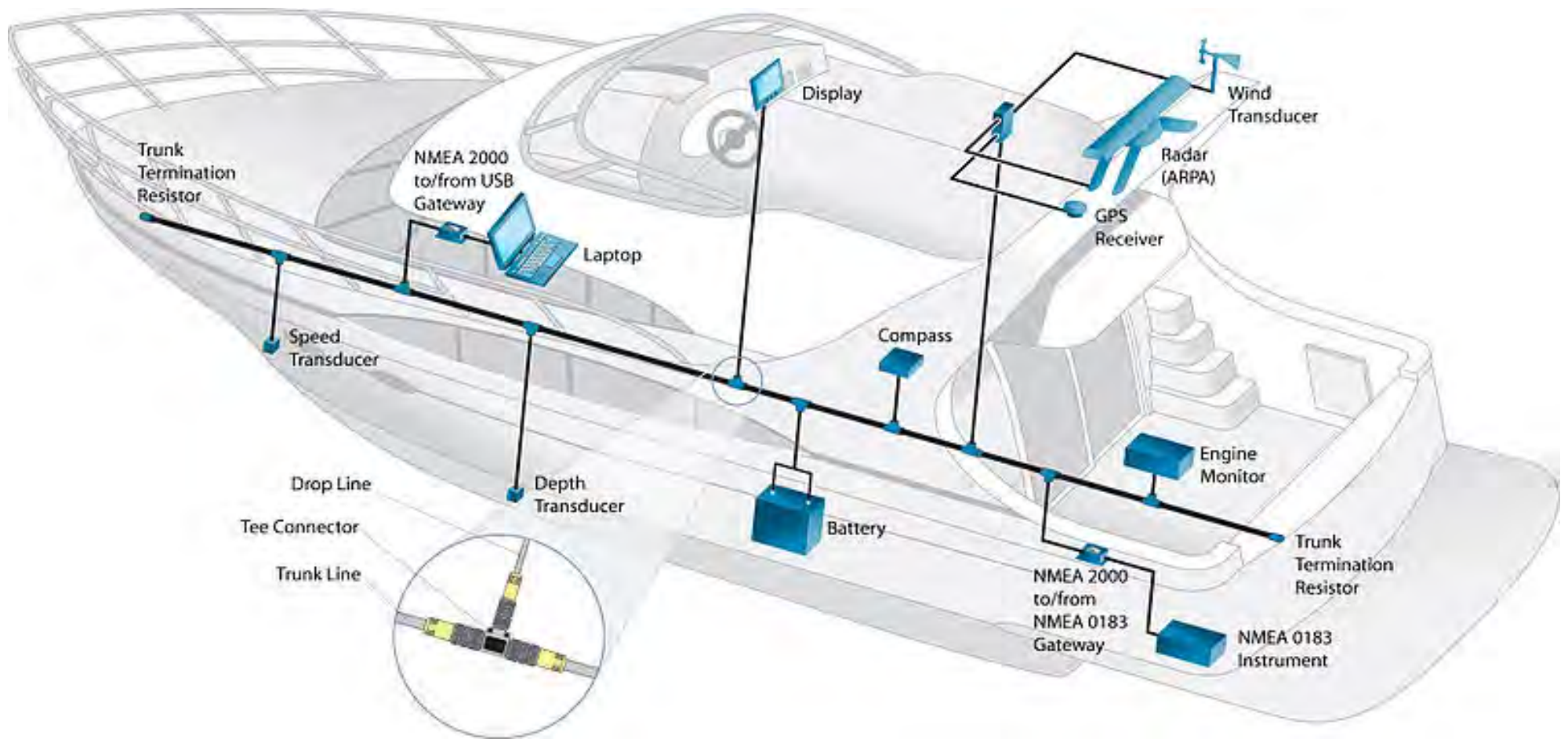

TYPICAL NMEA 2000 NETWORK COMPONENTS

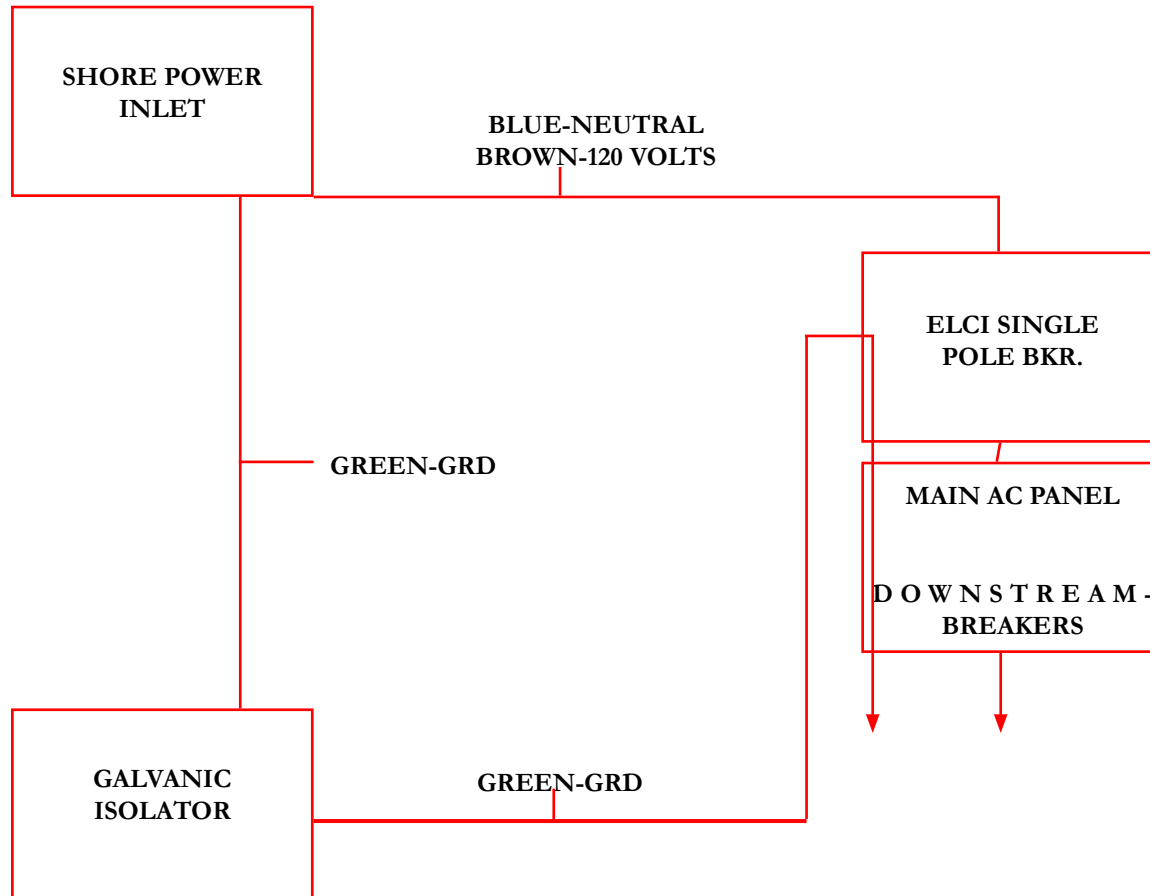

26 EXPRESS ELCI AC CIRCUIT FLOW CHART (TYPICAL)

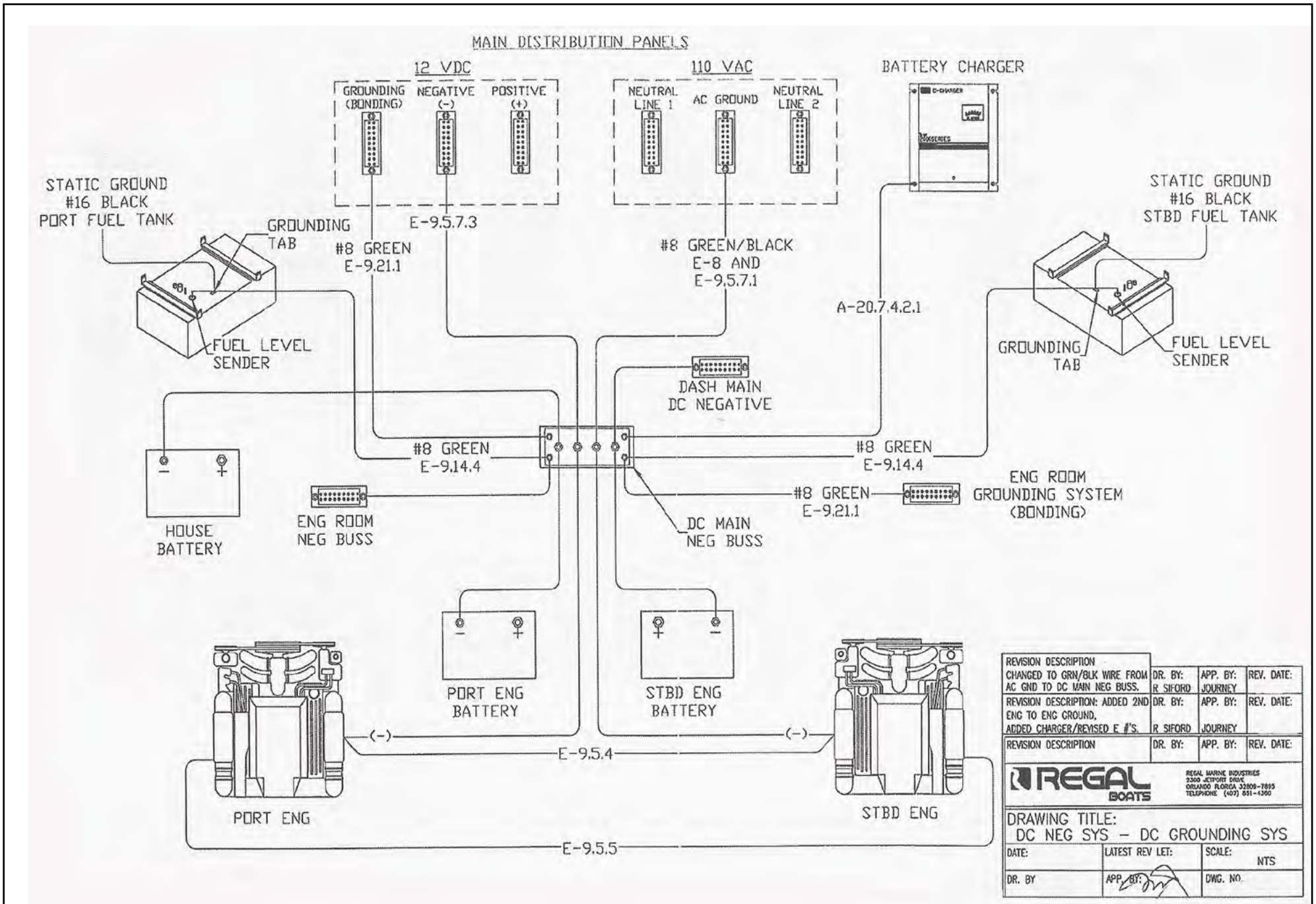

26 EXPRESS TYPICAL DC GROUND CIRCUITRY

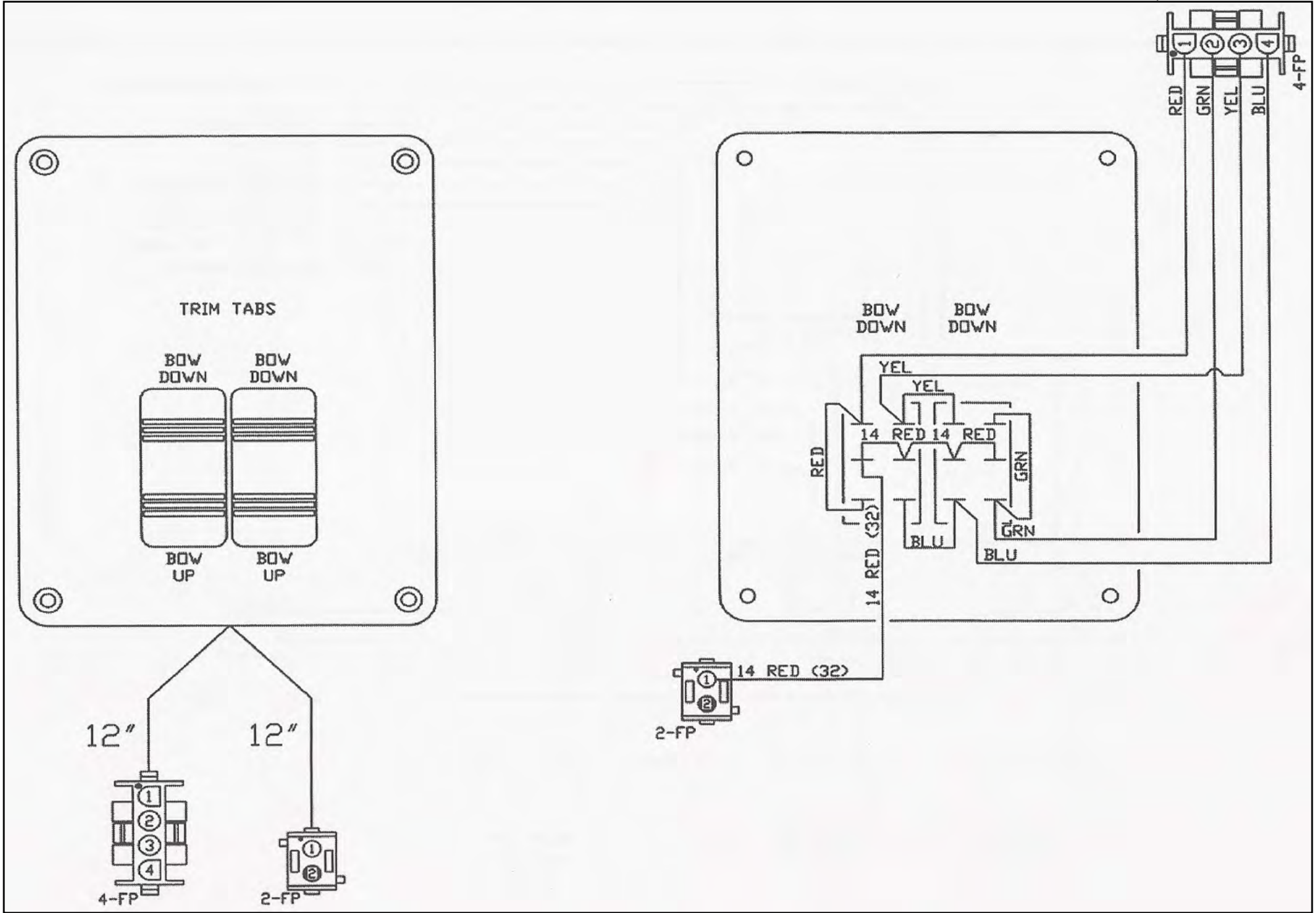

26 EXPRESS TYPICAL TRIM TAB SWITCH CIRCUITRY

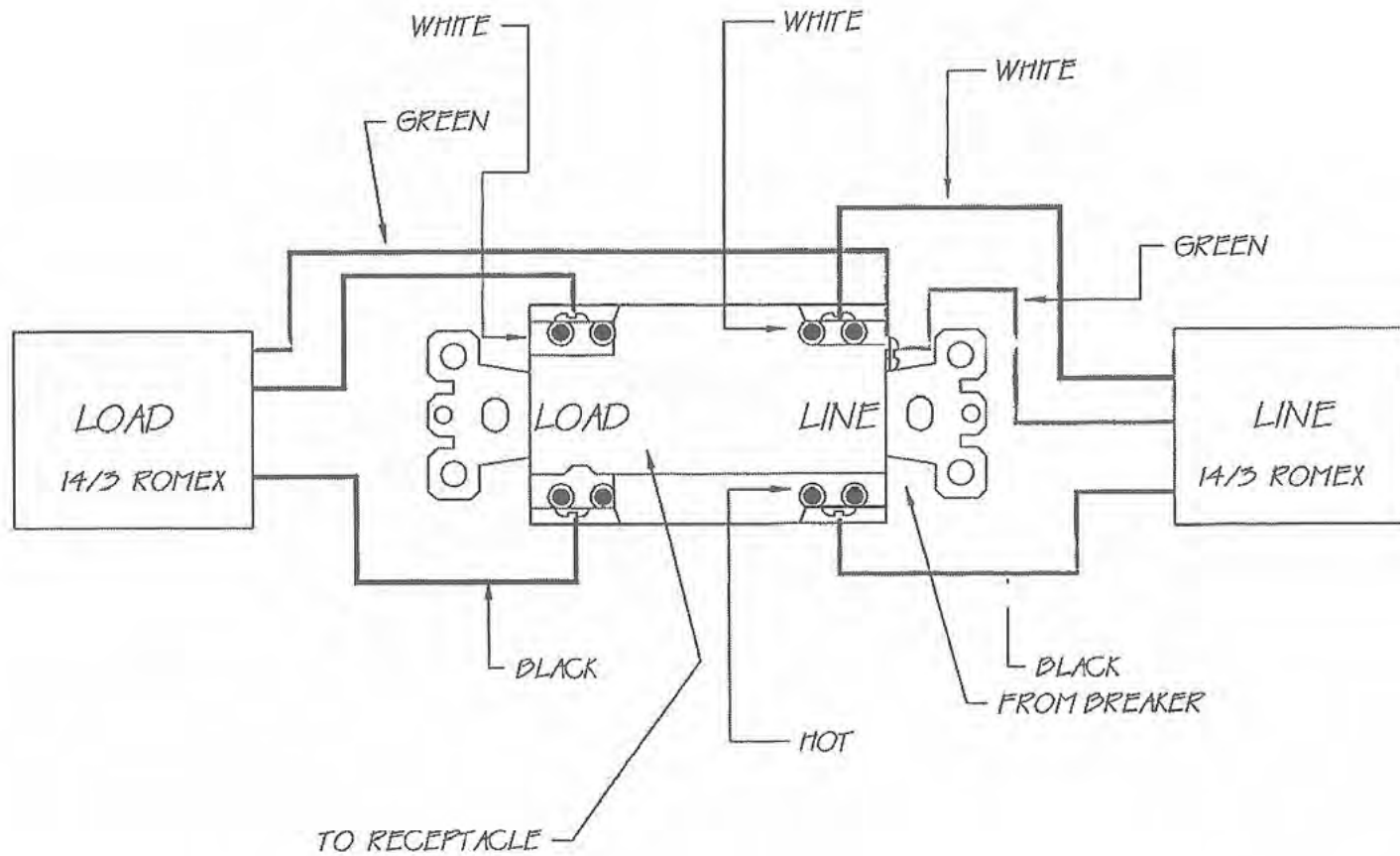

REVISION DESCRIPTION	DR. BY:	APP. BY:	REV. DATE:
		REGAL MARINE INDUSTRIES 2300 JETPORT DRIVE ISLAND FLORIDA 32009-7895 TELEPHONE (407) 851-4500	
DRAWING TITLE:			
110 VOLT GROUND FAULT CIRCUIT INTERRUPTER			
DATE:	LATEST REV LET:	SCALE:	
DR. BY:	APP. BY:	DWG. NO.:	

26 EXPRESS TYPICAL GFCI CIRCUITRY

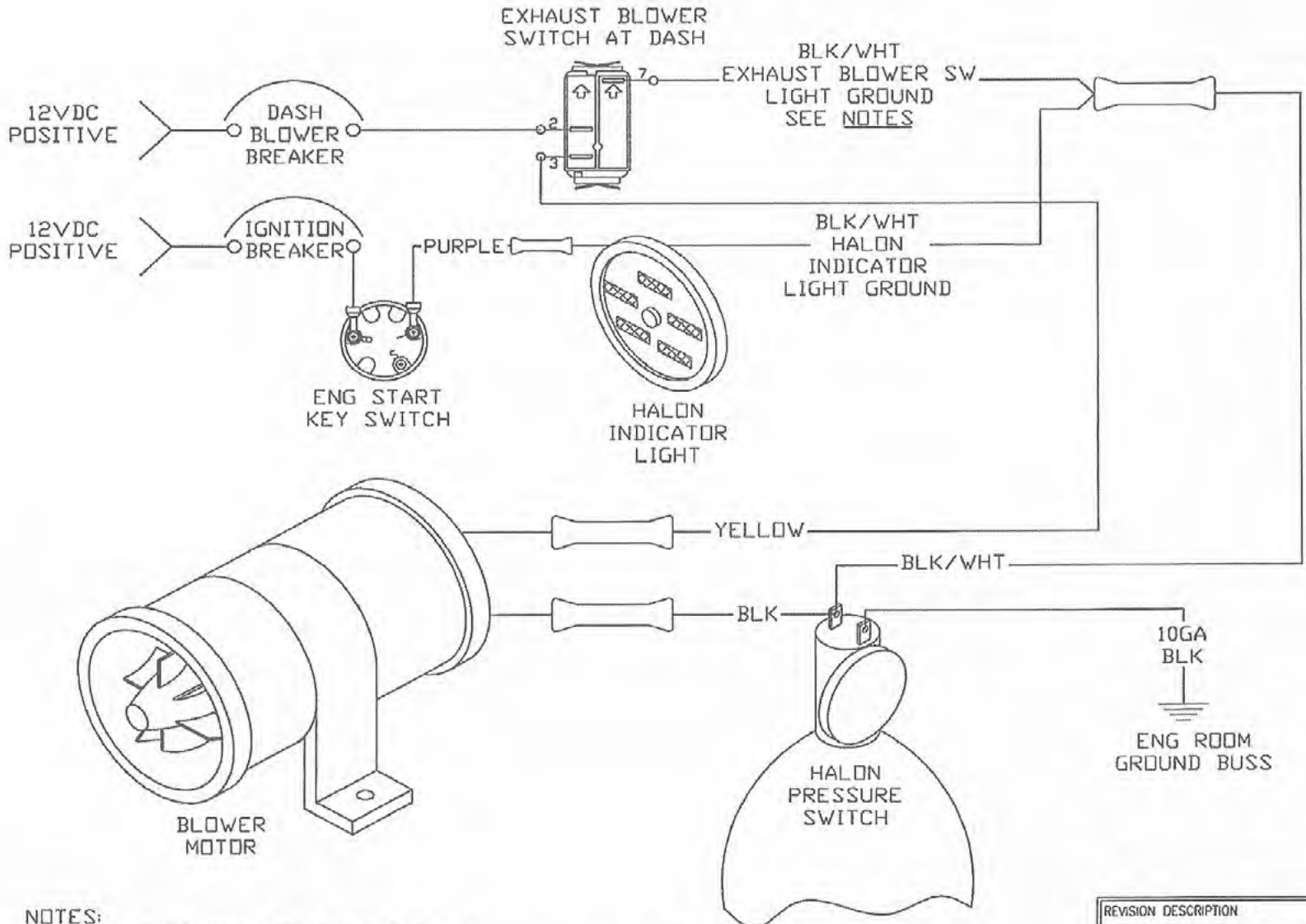

- NOTES:
1. FAILURE TO ISOLATE THIS GROUND WILL RESULT IN AN UNDESIRABLE OPERATION OF THE HALON EXTINGUISHER INDICATOR LIGHT.
 2. FAILURE TO ISOLATE THIS GROUND WILL RESULT IN AN UNDESIRABLE OPERATION OF THE DIESEL SHUTDOWN SYSTEM.

REVISION DESCRIPTION	DR. BY:	APP. BY:	REV. DATE:
			REGAL MARINE INDUSTRIES 2300 JETPORT DRIVE DAWSON FLORIDA 32003-2025 TELEPHONE (907) 651-4360
DRAWING TITLE: FIRE EXTINGUISHER SYSTEM GROUND			
DATE:	LATEST REV NUMBER:	[Signature]	
DR. BY:	DWG. NO.:		

26 EXPRESS TYPICAL FIRE EXTINGUISHER GROUND CIRCUITRY

MS-BT100 INSTALLATION DIAGRAM

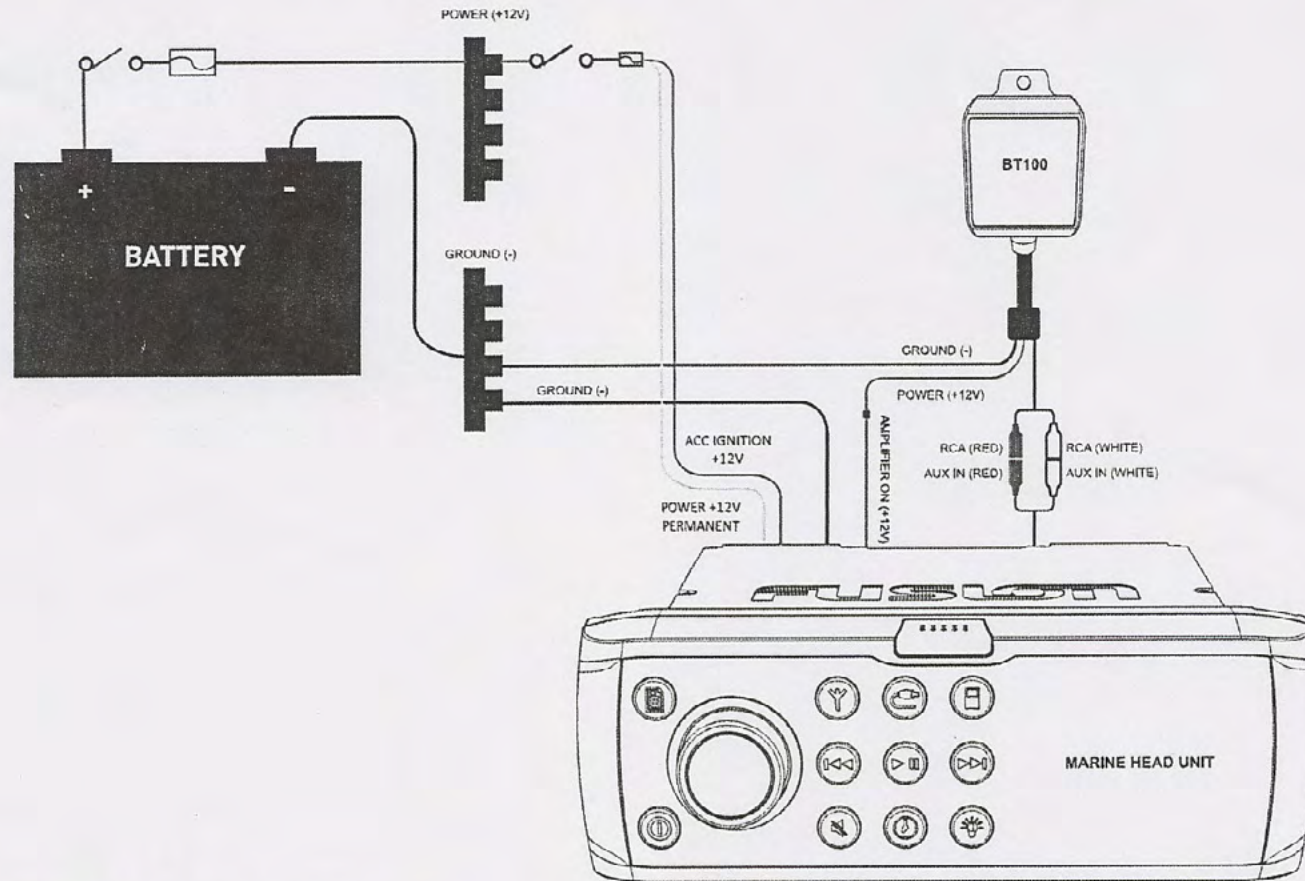

NOTE: MS-BT100 is compatible with any stereo with an AUX IN
In instances where the AMPLIFIER ON cable is not provided, simply wire the POWER +12V cable of the MS-BT100 to the POWER +12V of the connecting stereo.

Technical Information

PLUG/SOCKETS

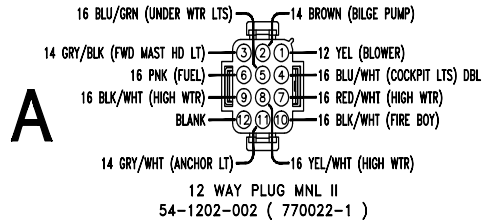

TRIM TABS / SOCKETS

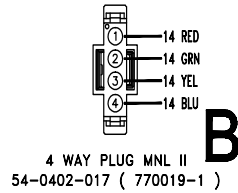

ARCH CAP/PINS

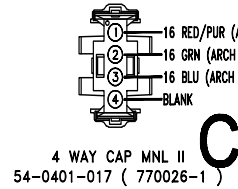

PLUG/SOCKETS

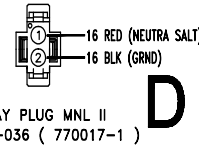

TO FWD DECK HRNS - PLUG/SOCKETS

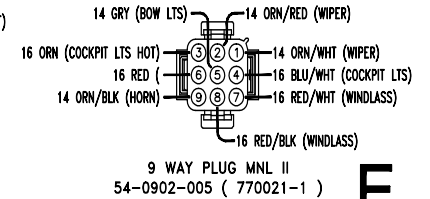

ACCESSORIES - PLUG/SOCKETS

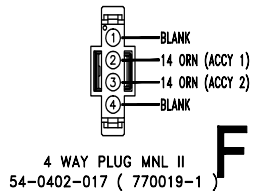

DECK GRNDS - PLUG/SOCKETS

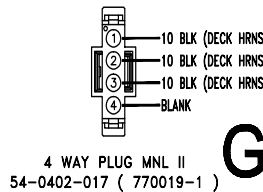

TO GAUGE PANEL - CAP/PINS

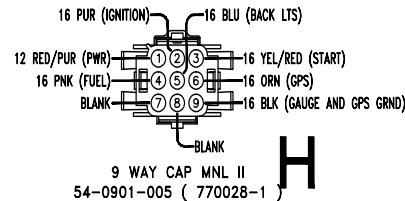

PLUG/SOCKETS

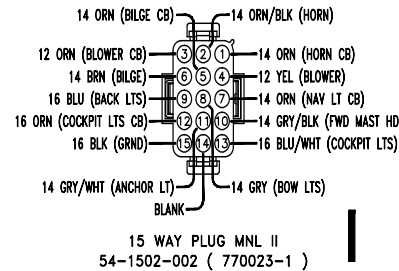

CAP/PINS

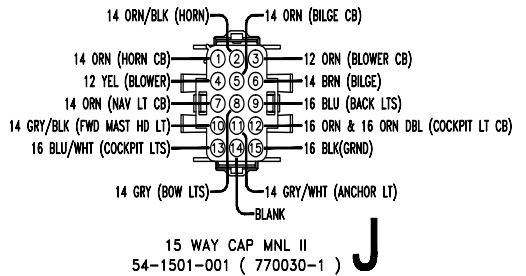

TO BREAKER PANEL CAP/PINS

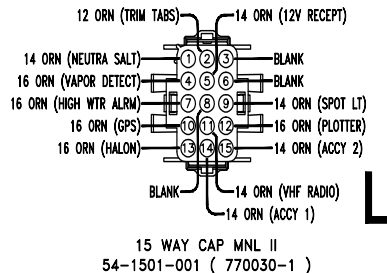
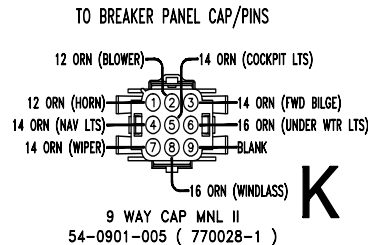

PLUG/SOCKETS

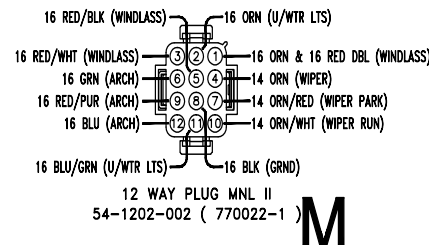

RIGHT SIDE SWITCHES - CAP/PINS

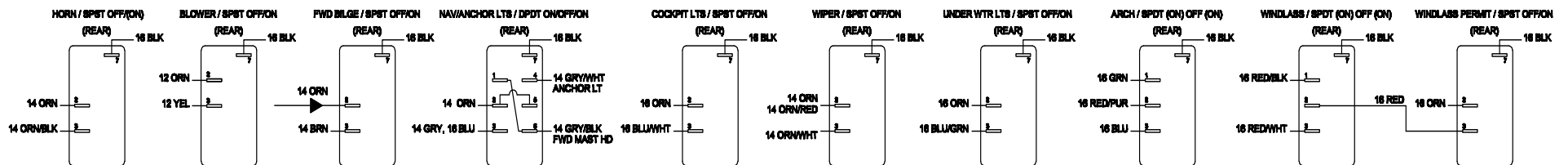
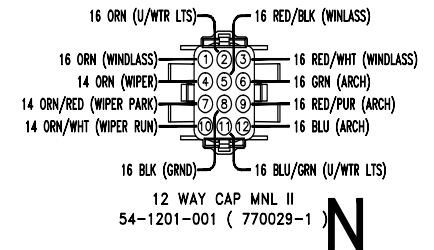

26 EXPRESS TYPICAL SWITCH PANEL HARNESS PLUG CIRCUITRY

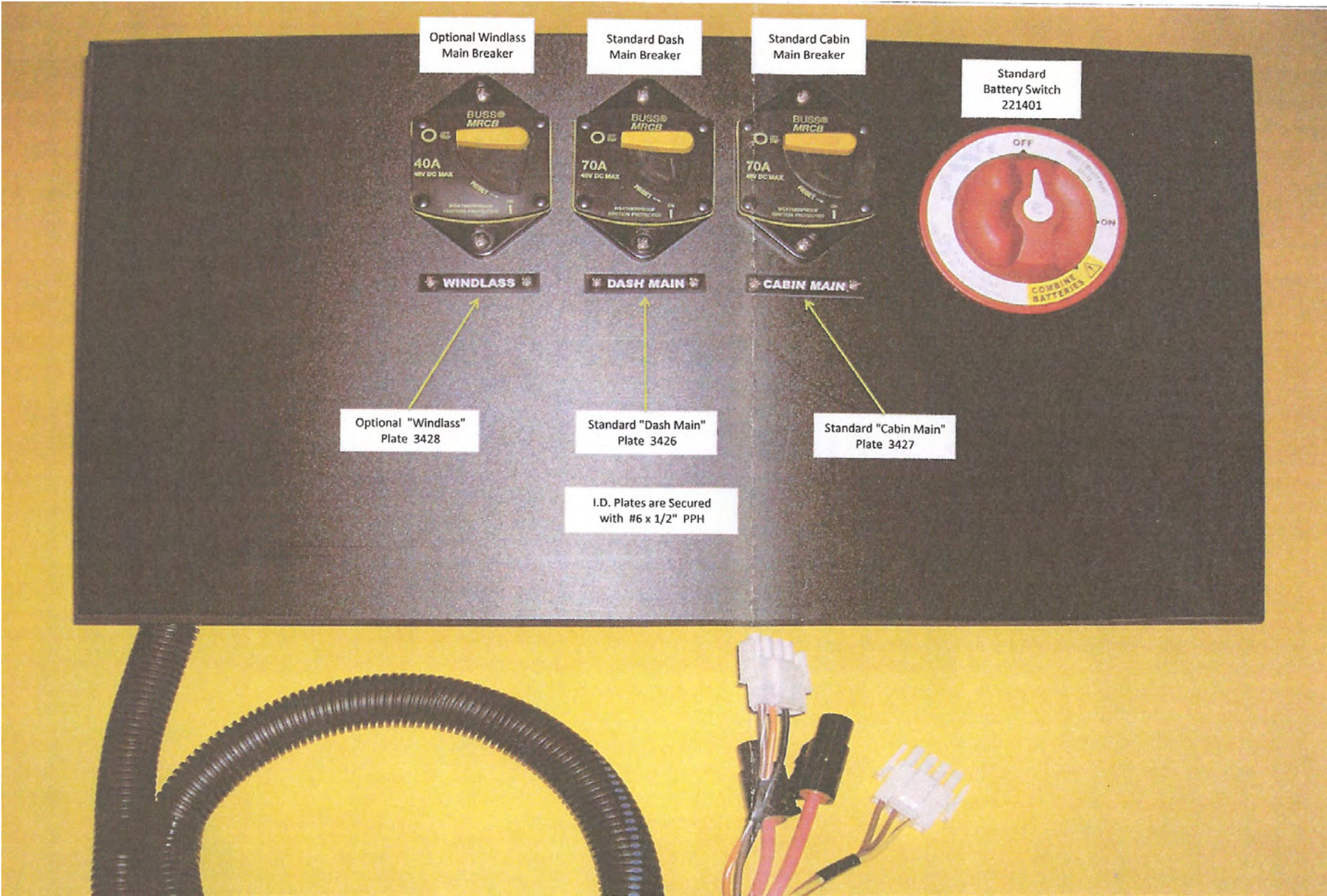

26 EXPRESS BATTERY MANAGEMENT PANEL (FRONT) CIRCUITRY

Technical Information

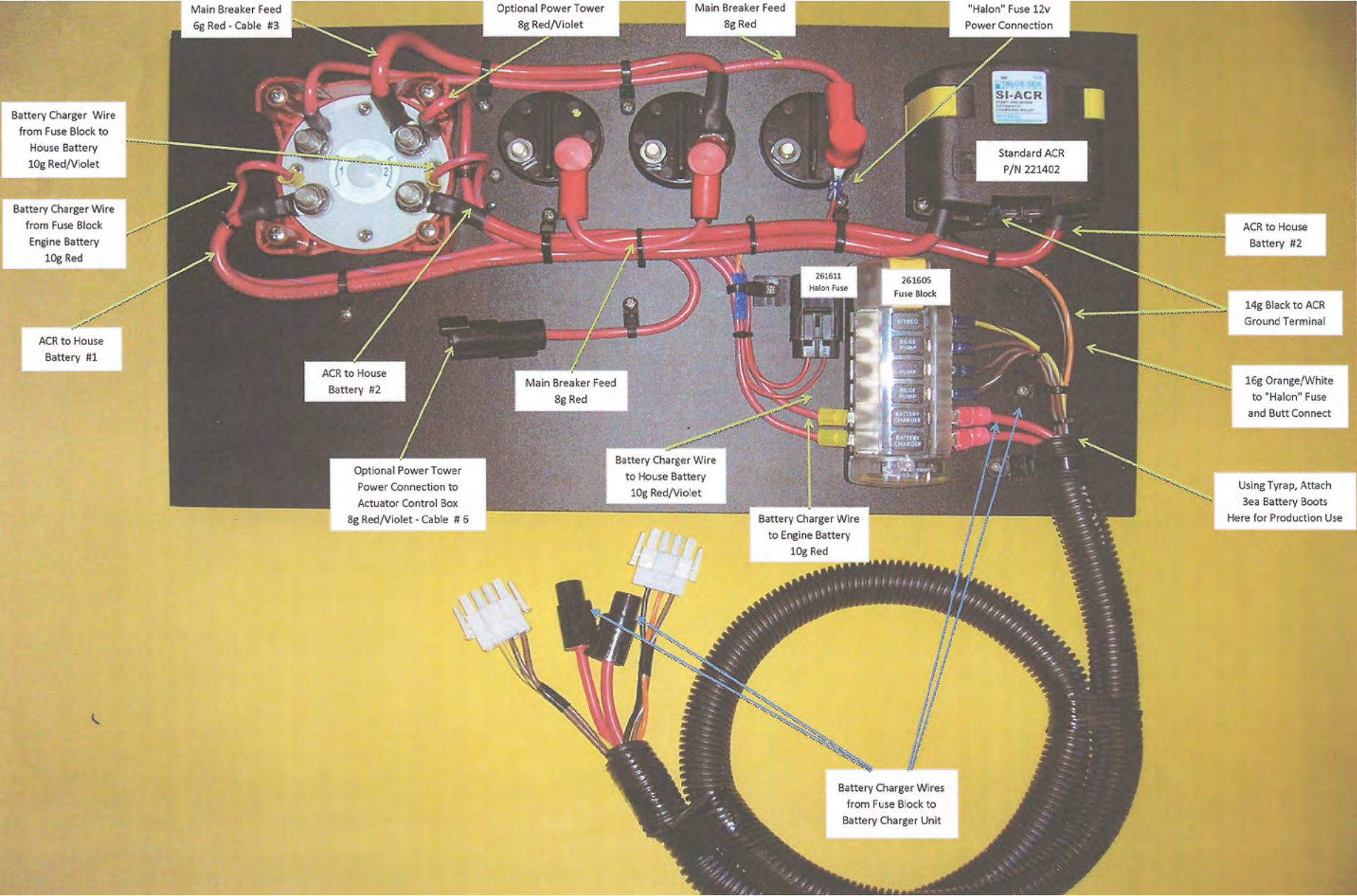

26 EXPRESS BATTERY MANAGEMENT PANEL (REAR) CIRCUITRY

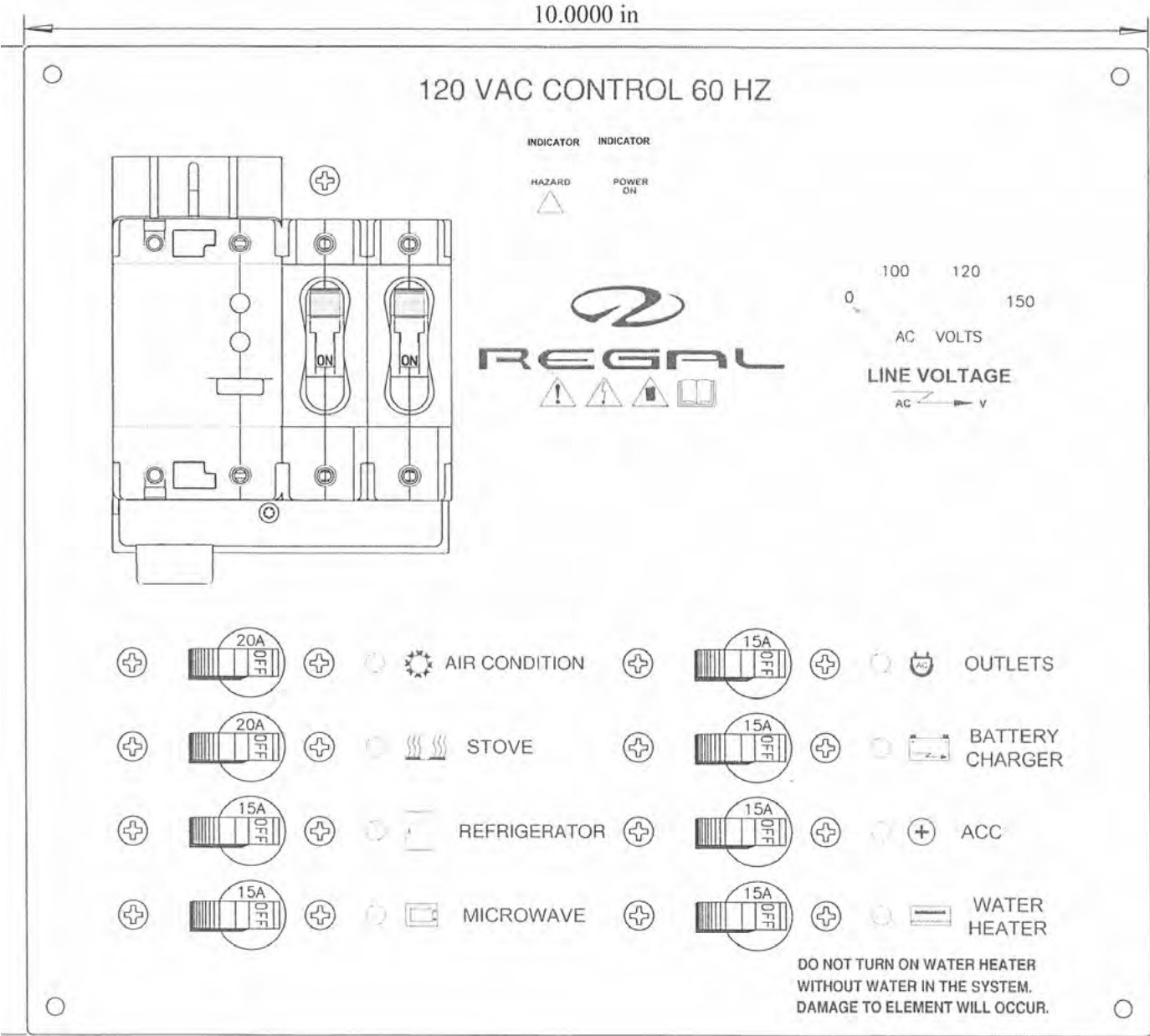

26 EXPRESS DOMESTIC 120 VOLT MAIN AC PANEL

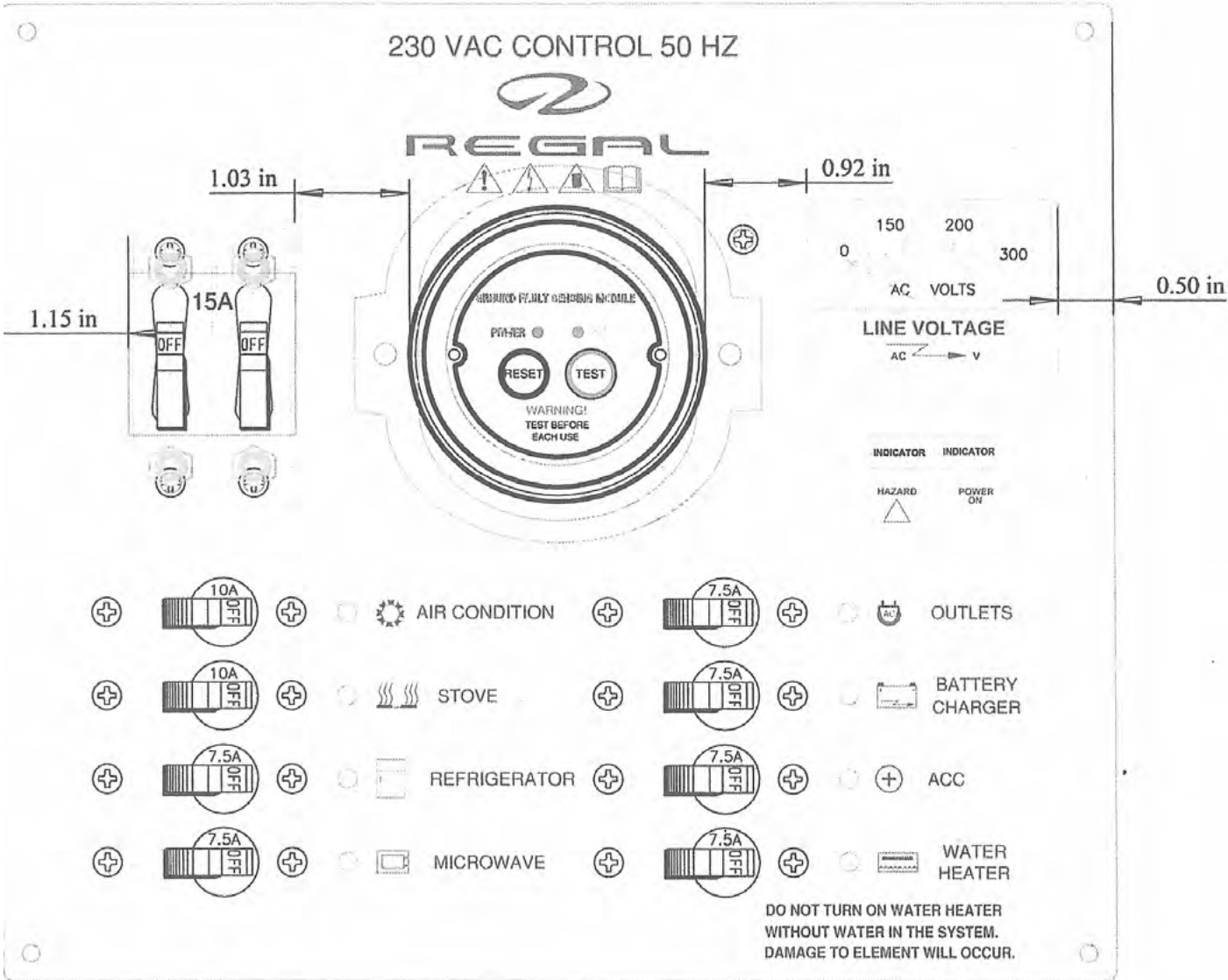

26 EXPRESS OVERSEAS 230 VOLT MAIN AC PANEL

Subject Work Instruction: 26 Express (HN) Halon - Blower Shut Down	Issue Date: 04-17-15	Rev: 0	Document No. WI - 1381
Approved By: Mark Journey	Written By: Mark Journey	Rev. Date: -----	Page: 1 of 1

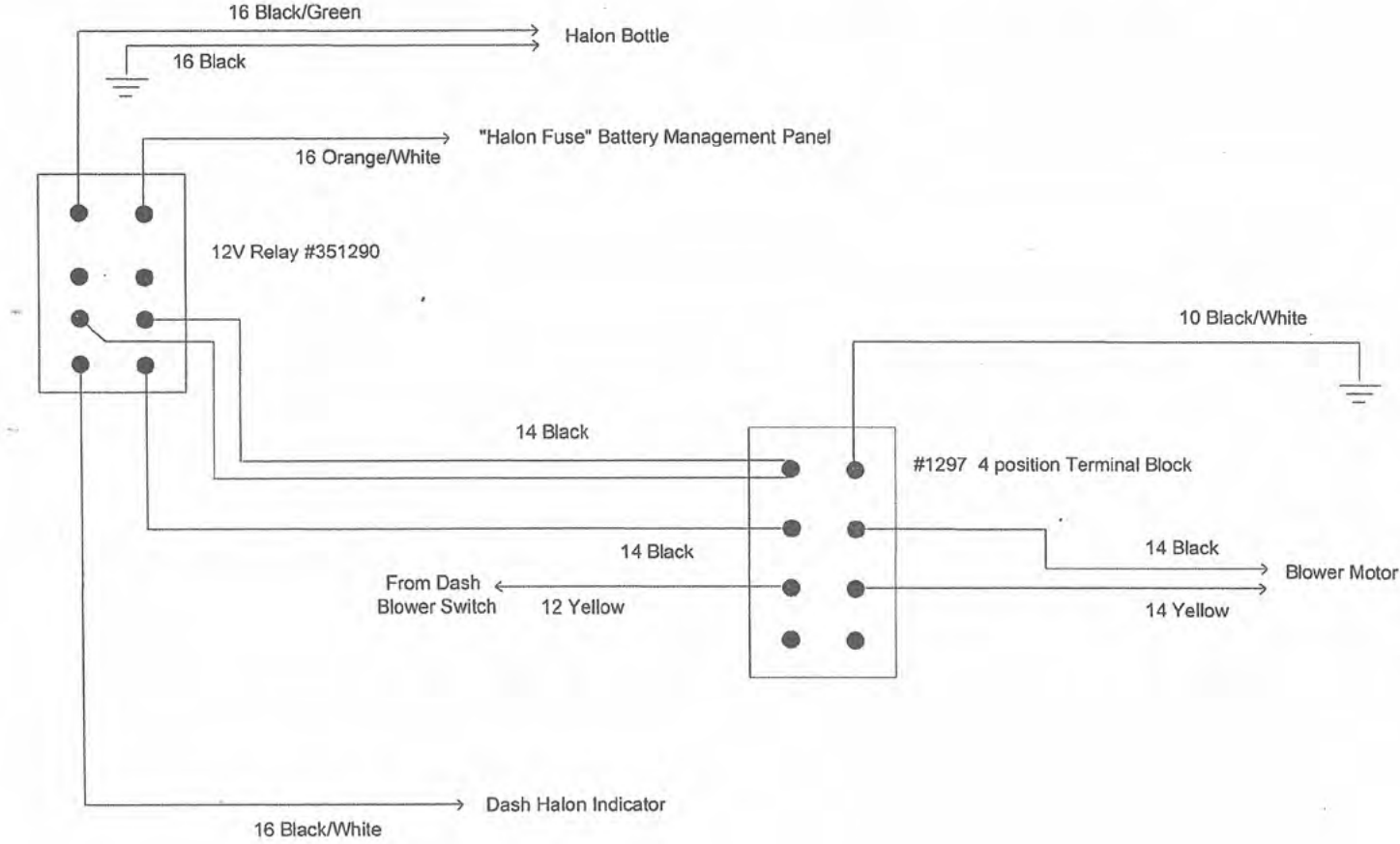

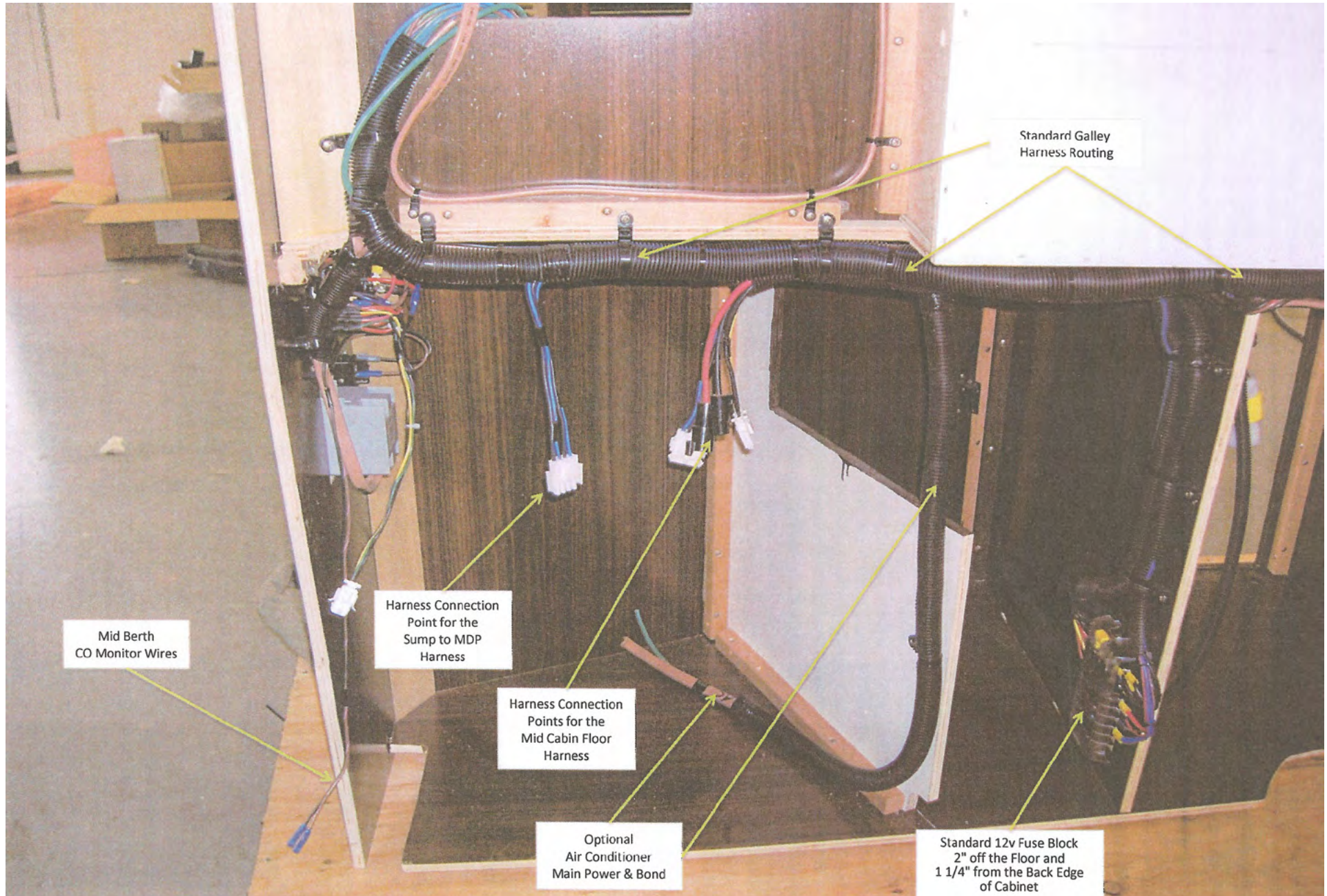

26 EXPRESS GALLEY ELECTRIC BREAKOUT 1

Technical Information

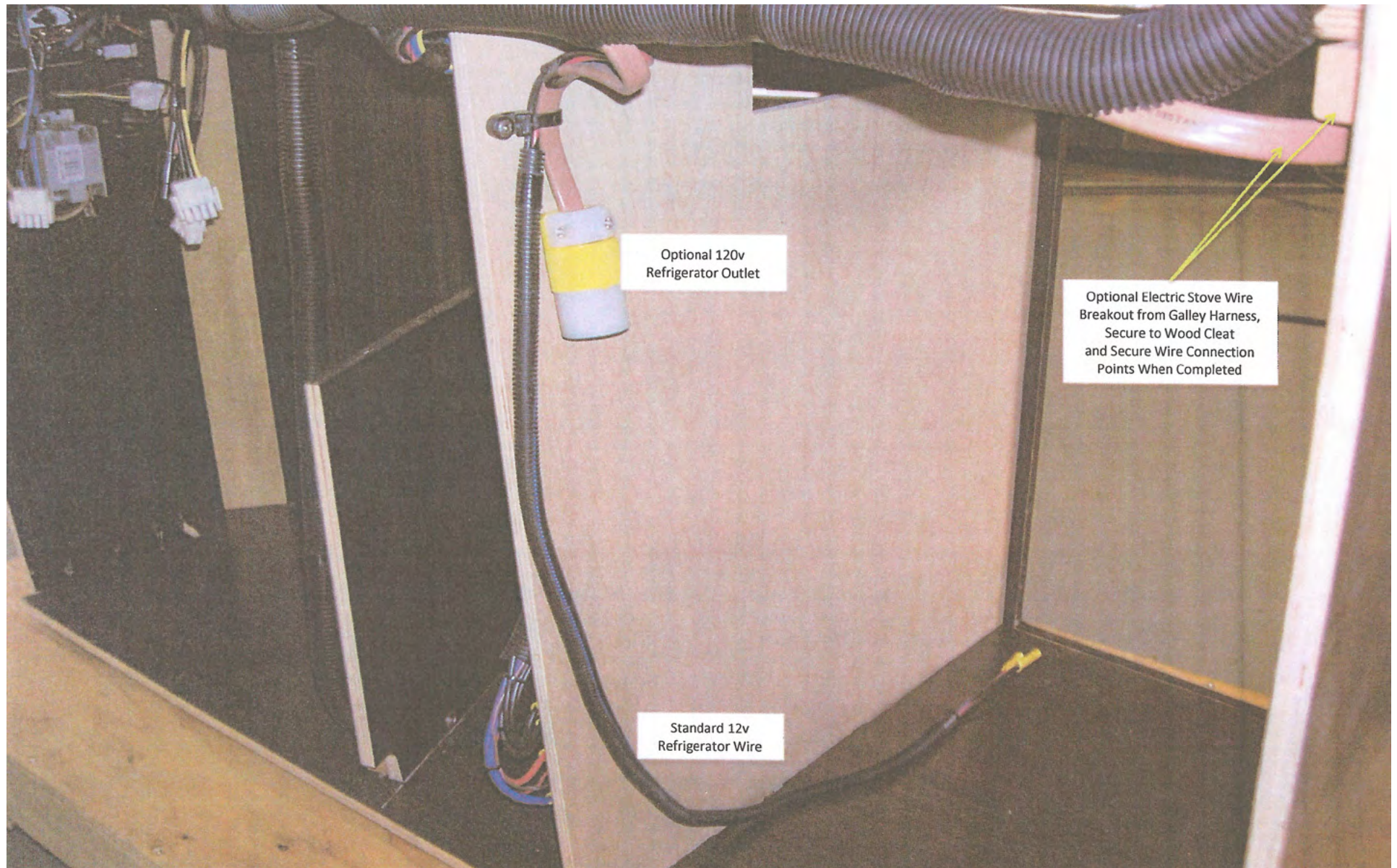

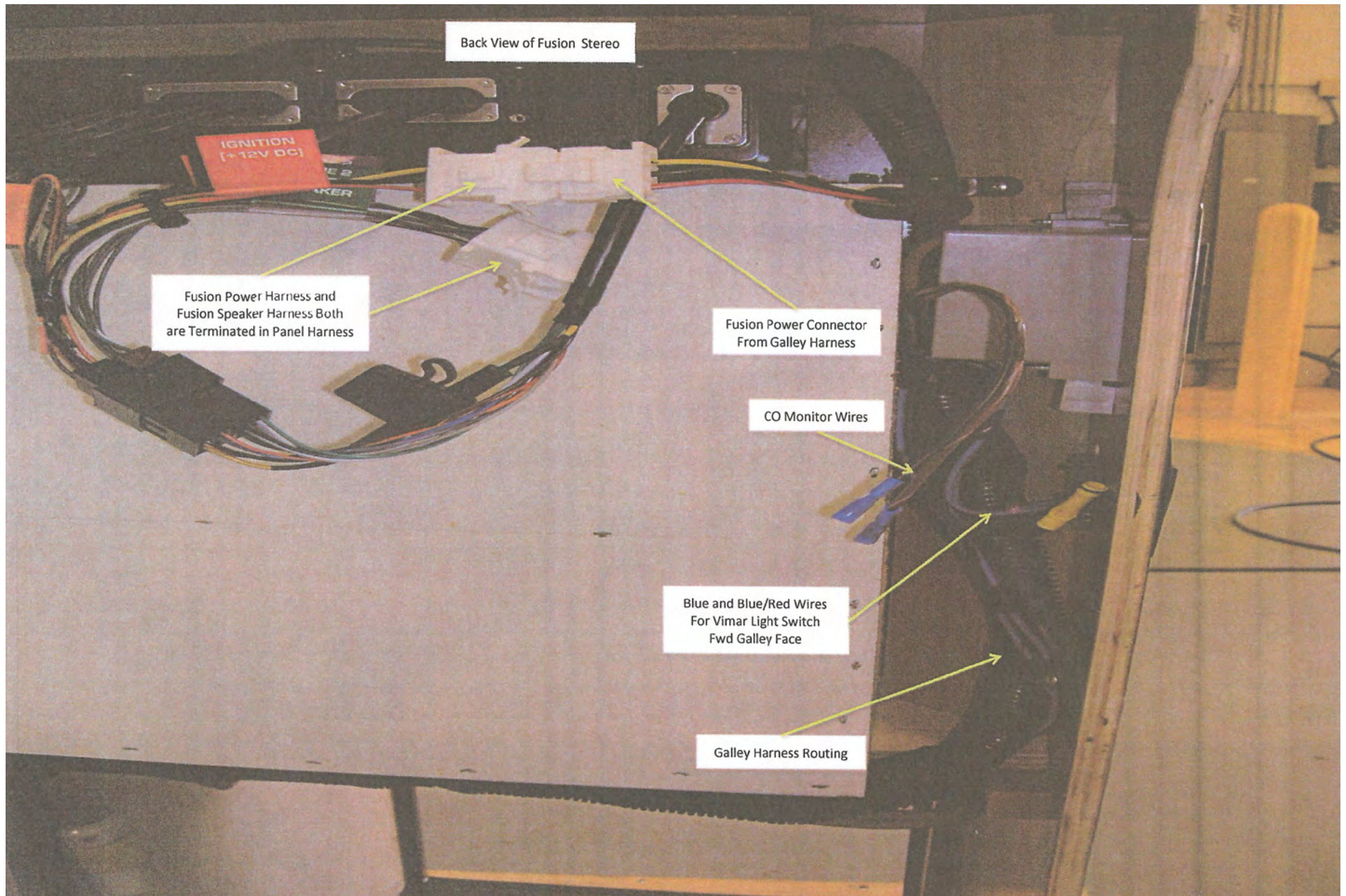

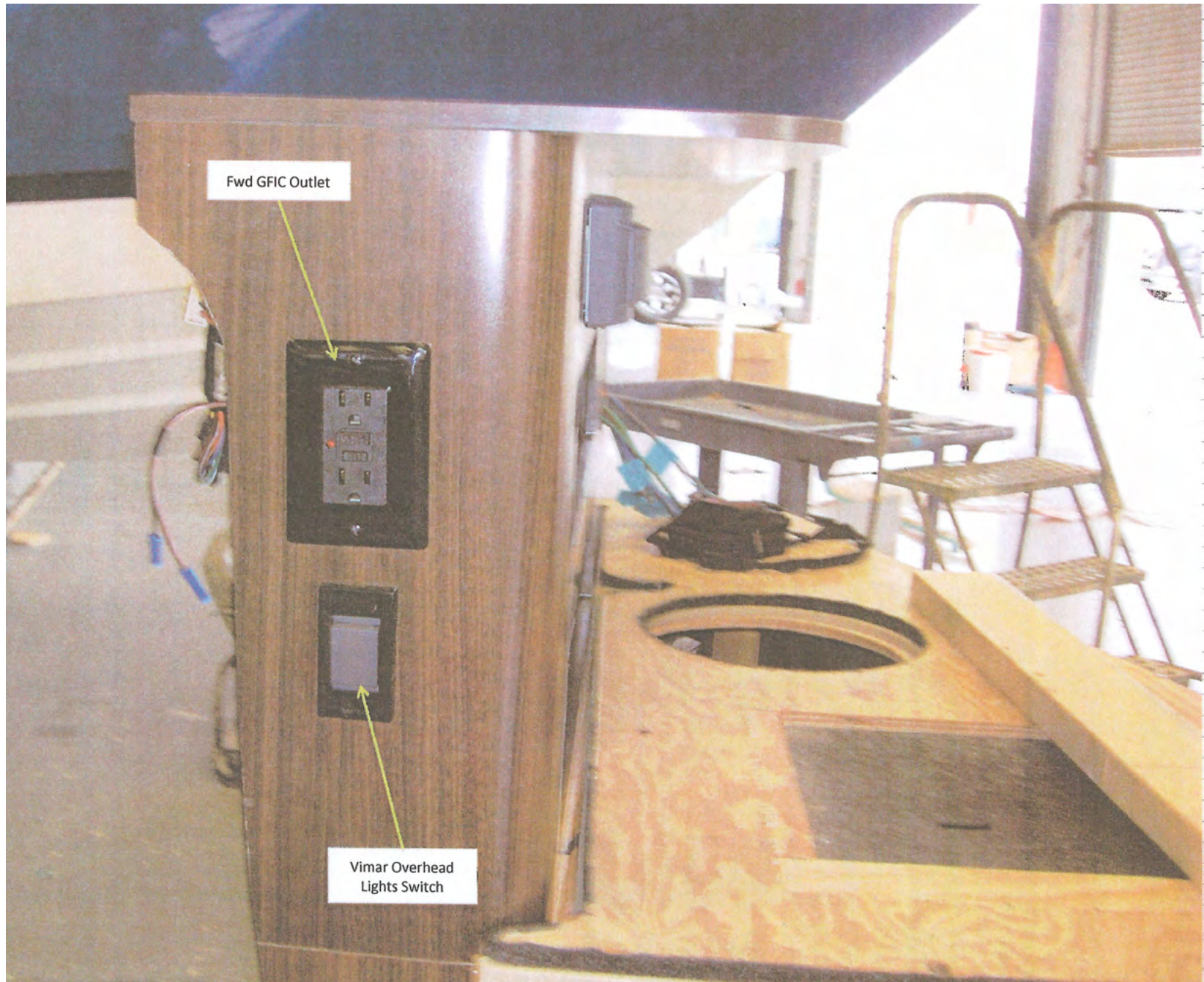

26 EXPRESS GALLEY ELECTRIC BREAKOUT 4

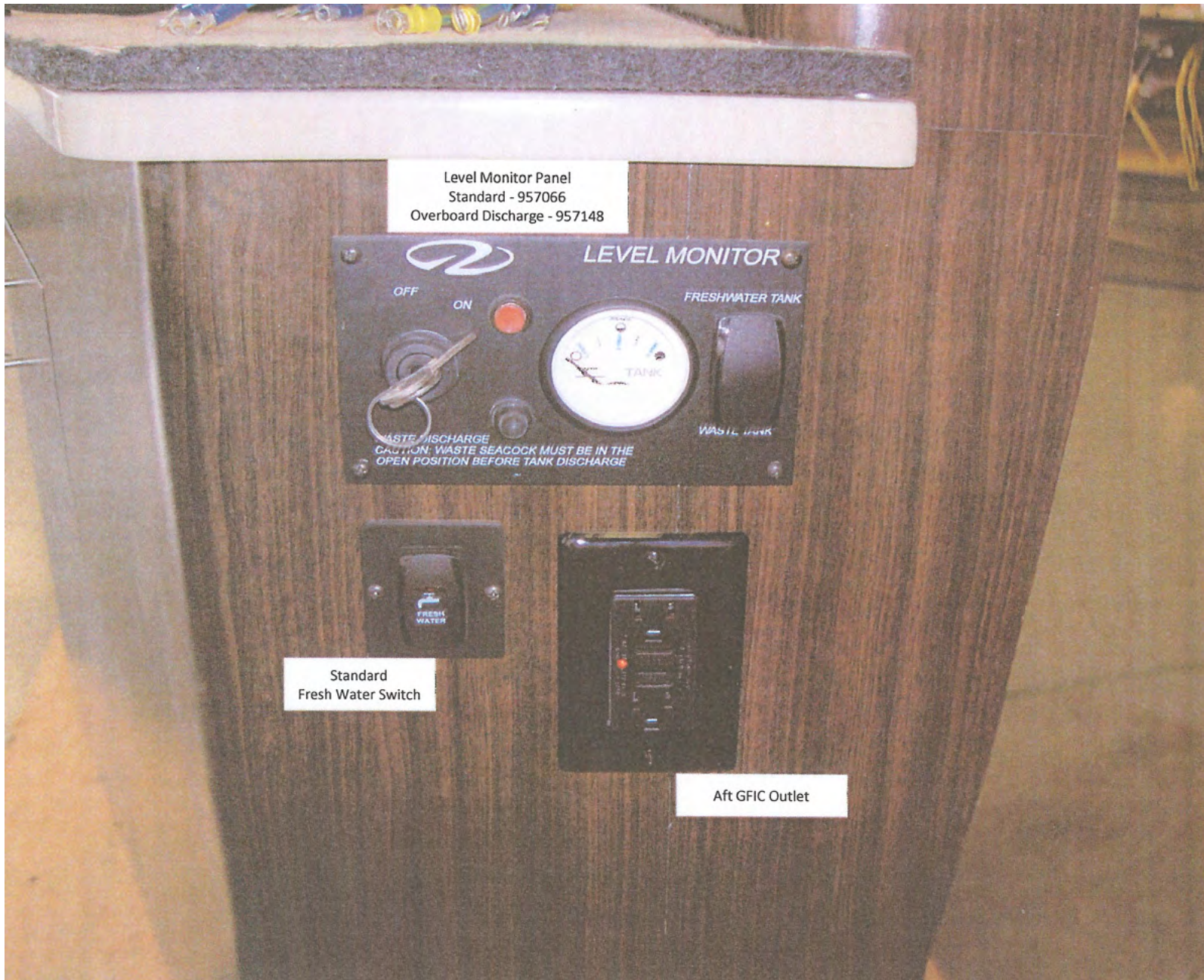

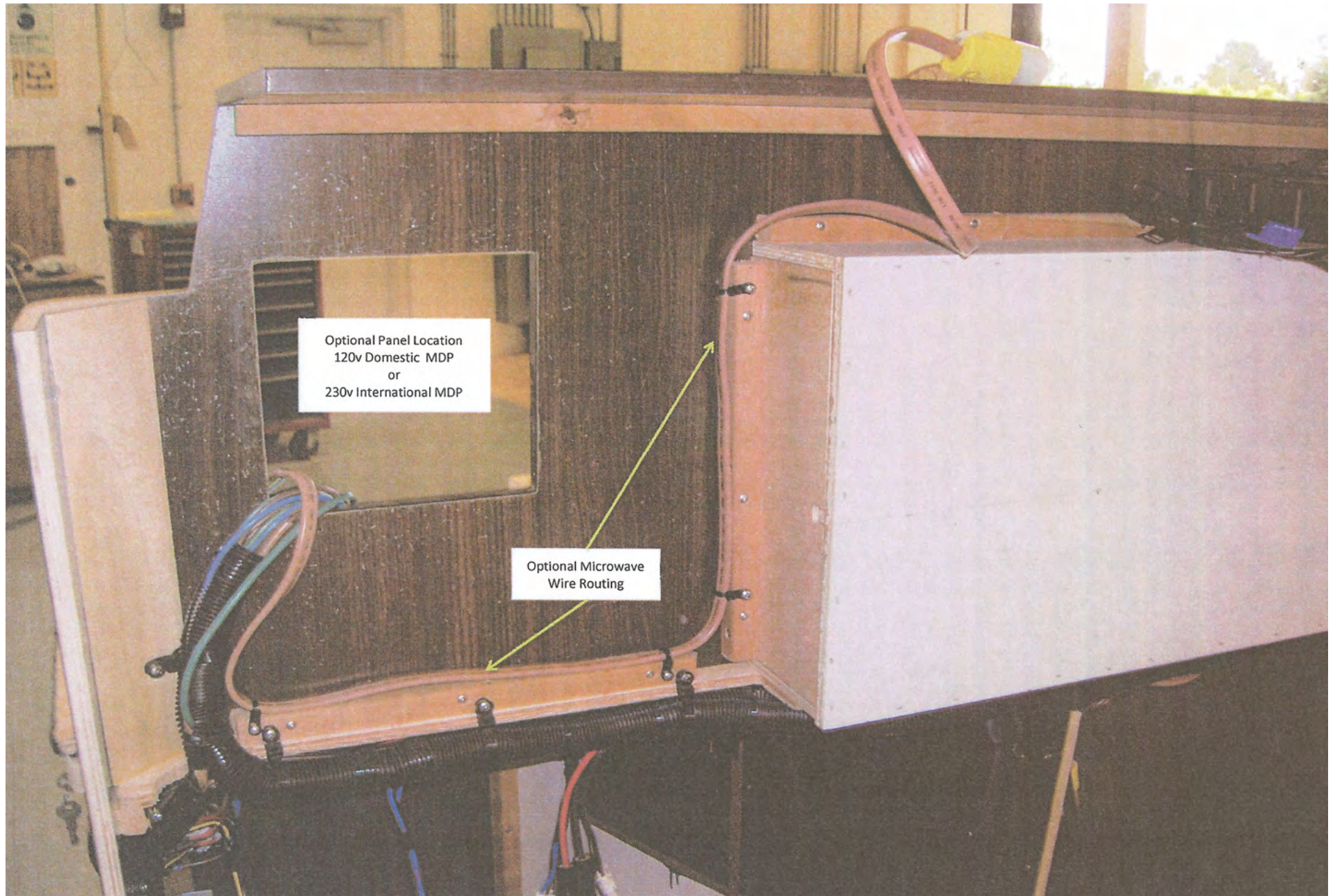

Optional Panel Location
120v Domestic MDP
or
230v International MDP

Optional Microwave
Wire Routing

TYPICAL VACUUM TYPE PLUMBING LAYOUT

WASTE SYSTEM-LATER MODELS

1. Toilet Bowl
2. Solenoid Valve
3. Fresh Water Pressure Pump
4. System Vent
5. Holding Tank
6. Fresh Water Tank (System can also run from dockside water supply)

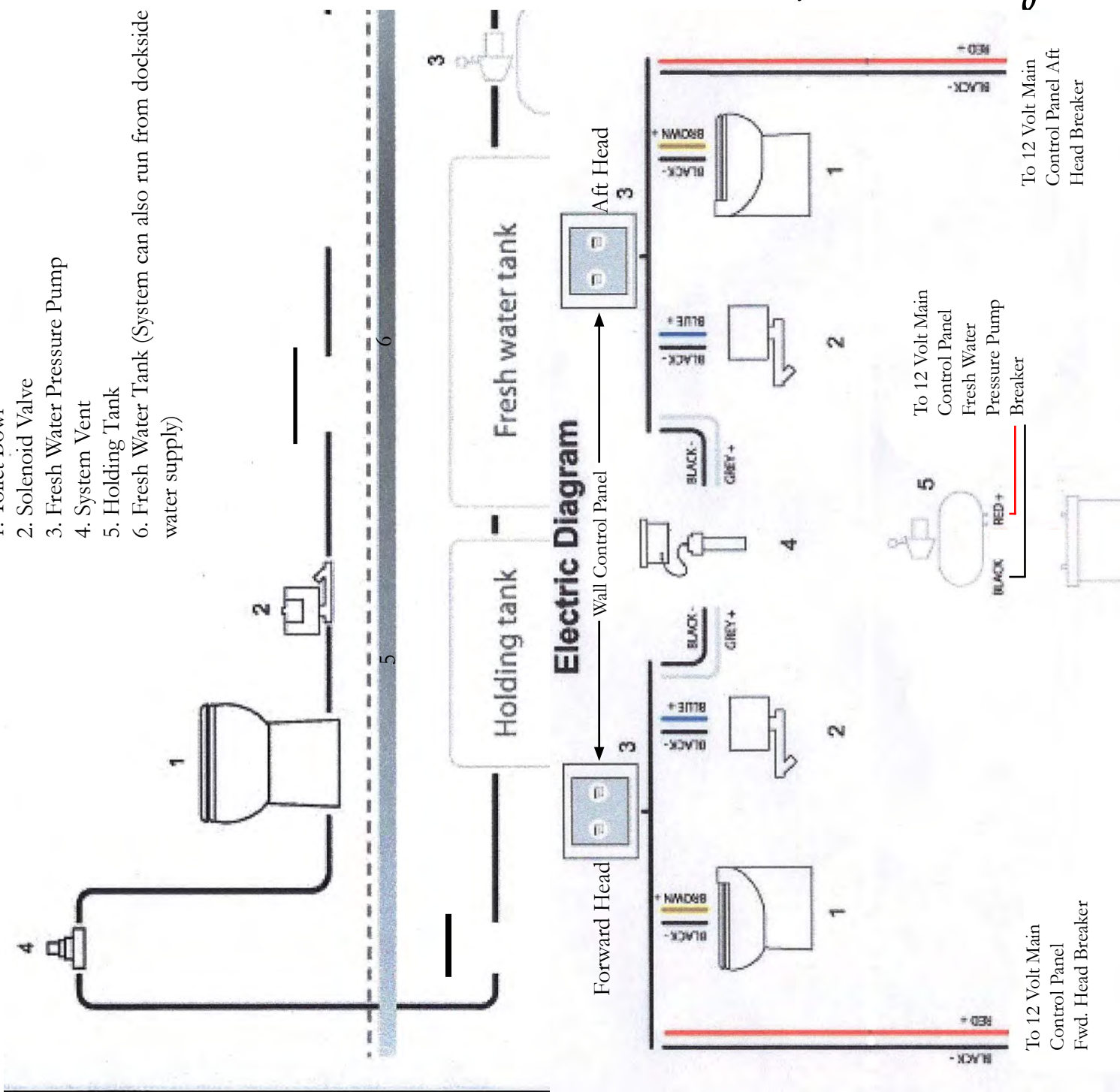

Technical Information

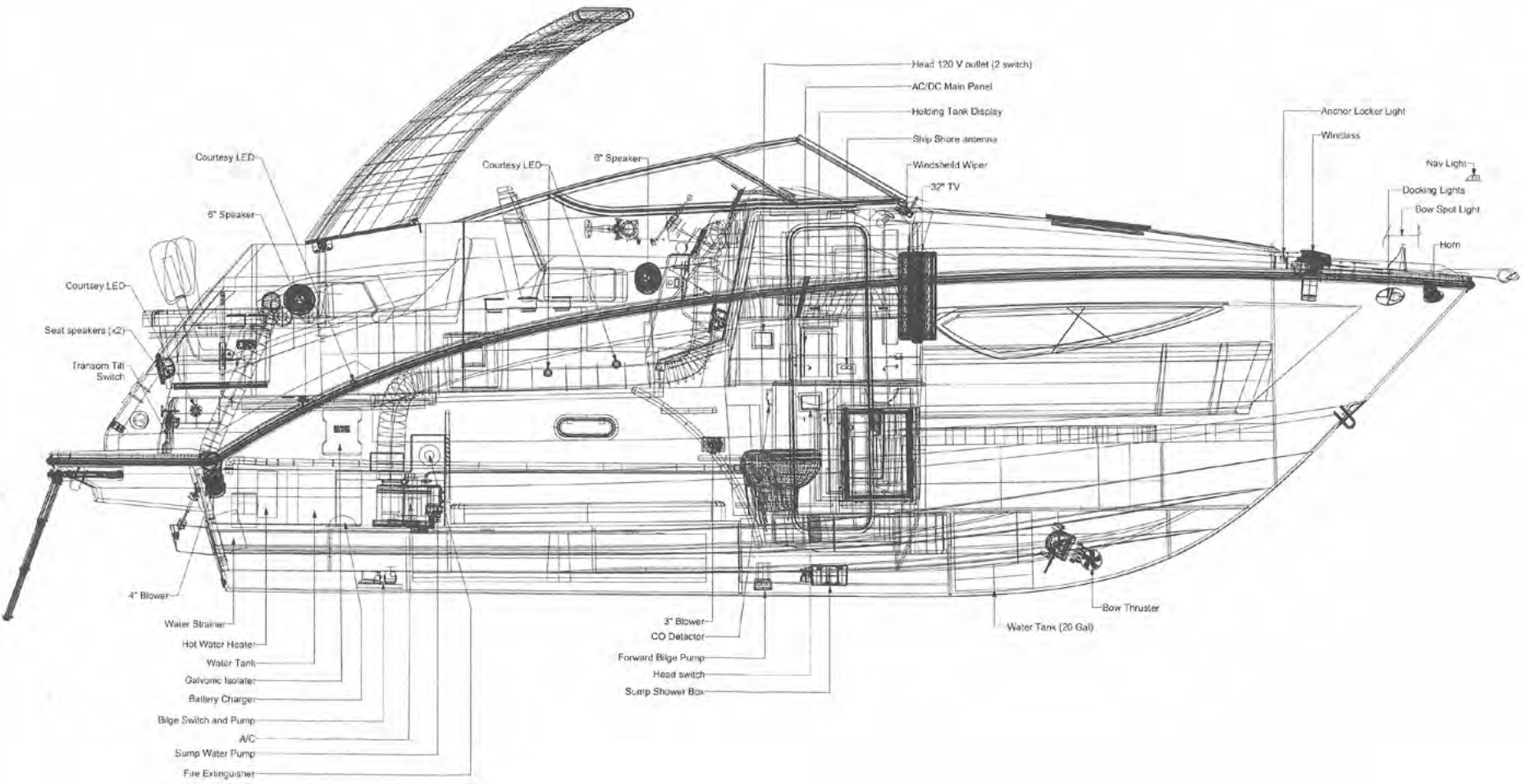

26 EXPRESS MACHINERY LAYOUT PROFILE VIEW EXPLODED

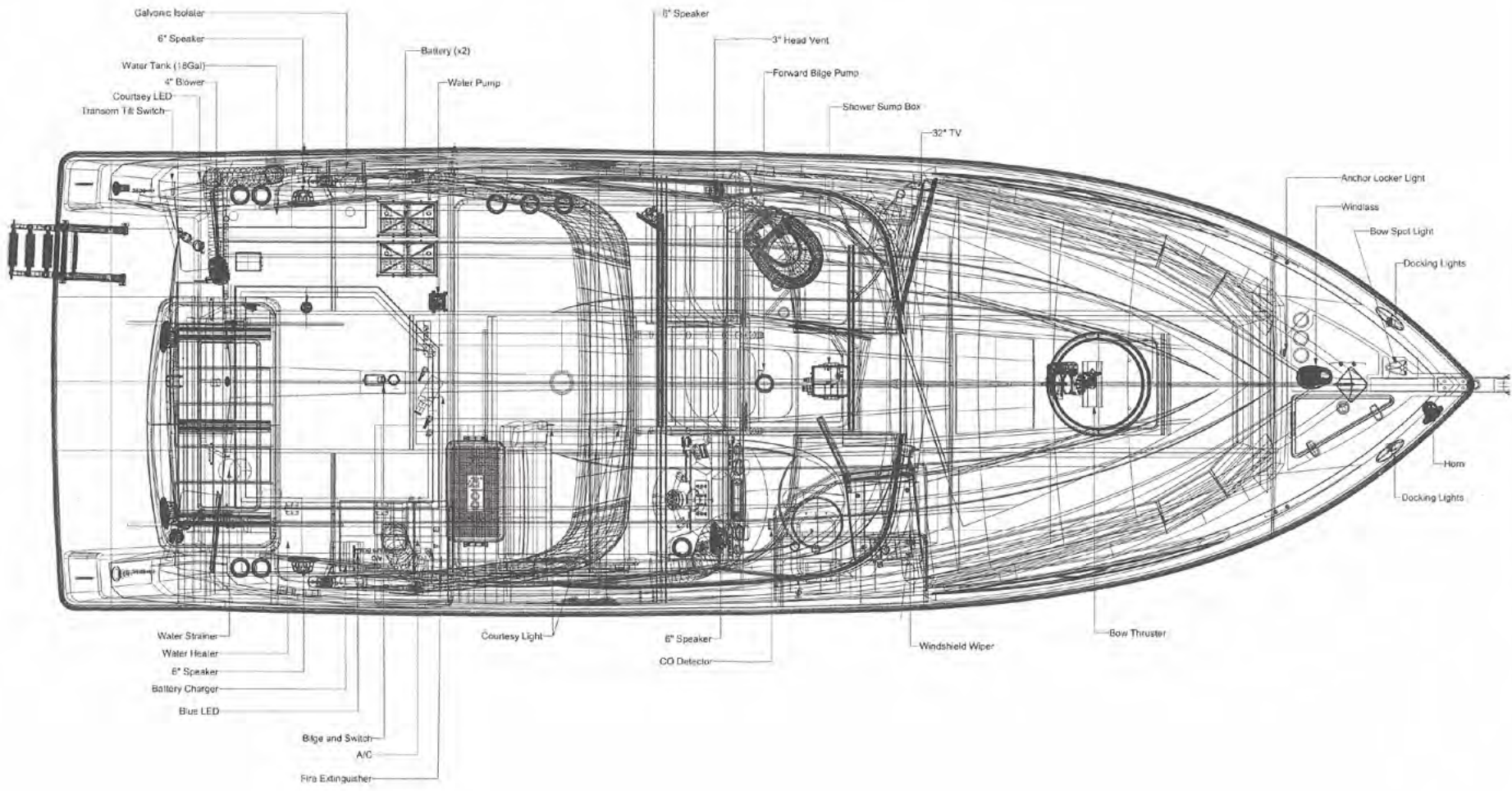

26 EXPRESS MACHINERY LAYOUT TOP VIEW EXPLODED

Plan Deck View of Equipment Layout

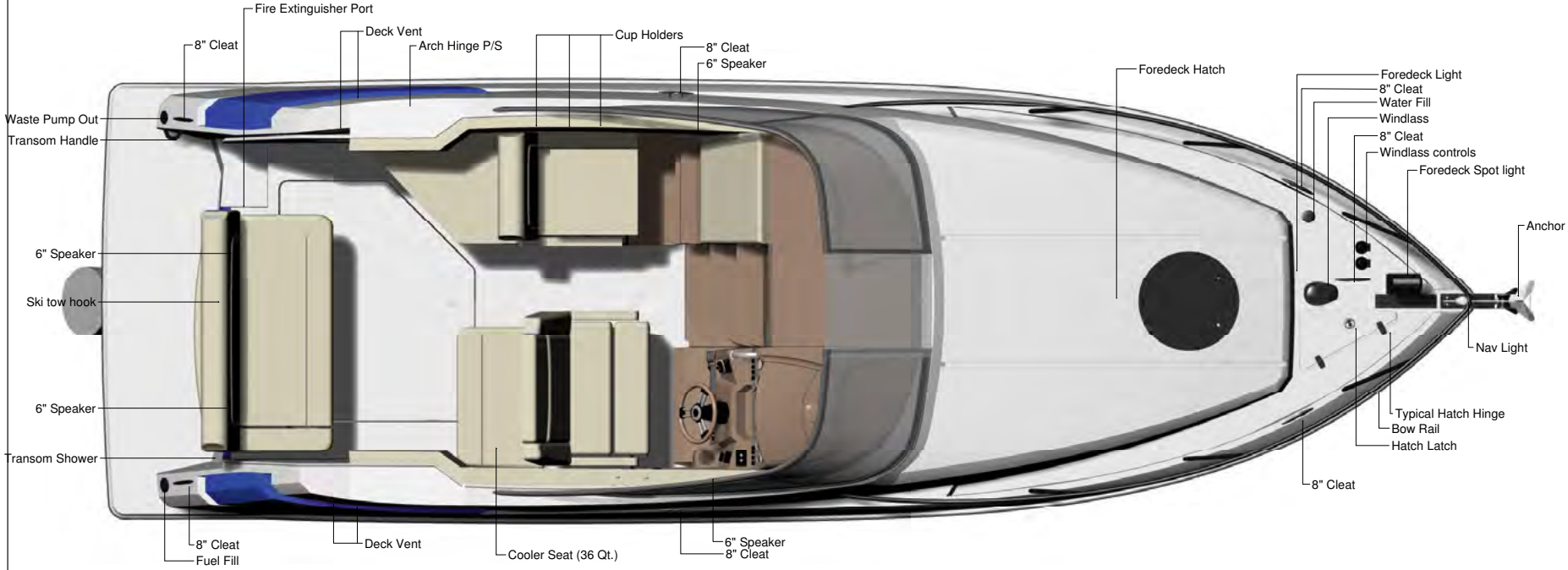

PROPRIETARY AND CONFIDENTIAL:
THE INFORMATION CONTAINED IN THIS DRAWING IS THE SOLE PROPERTY OF REGAL MARINE INDUSTRIES. ANY REPRODUCTION IN PART OR AS WHOLE WITHOUT THE WRITTEN PERMISSION OF REGAL MARINE INDUSTRIES IS PROHIBITED.

 REGAL MARINE INDUSTRIES 2300 JETPORT DRIVE ORLANDO, FLORIDA 32809 TEL: (407) 551-4360 ALL RIGHTS RESERVED		
DRAWING TITLE:		
26 Ex Deck Hardware		
DATE:	REVISION:	PAGE:
4/8/15	-	1 OF 1
DRAWN BY:	APPROVED BY:	DWG. NO.:
JAL	DR	14

STBD View

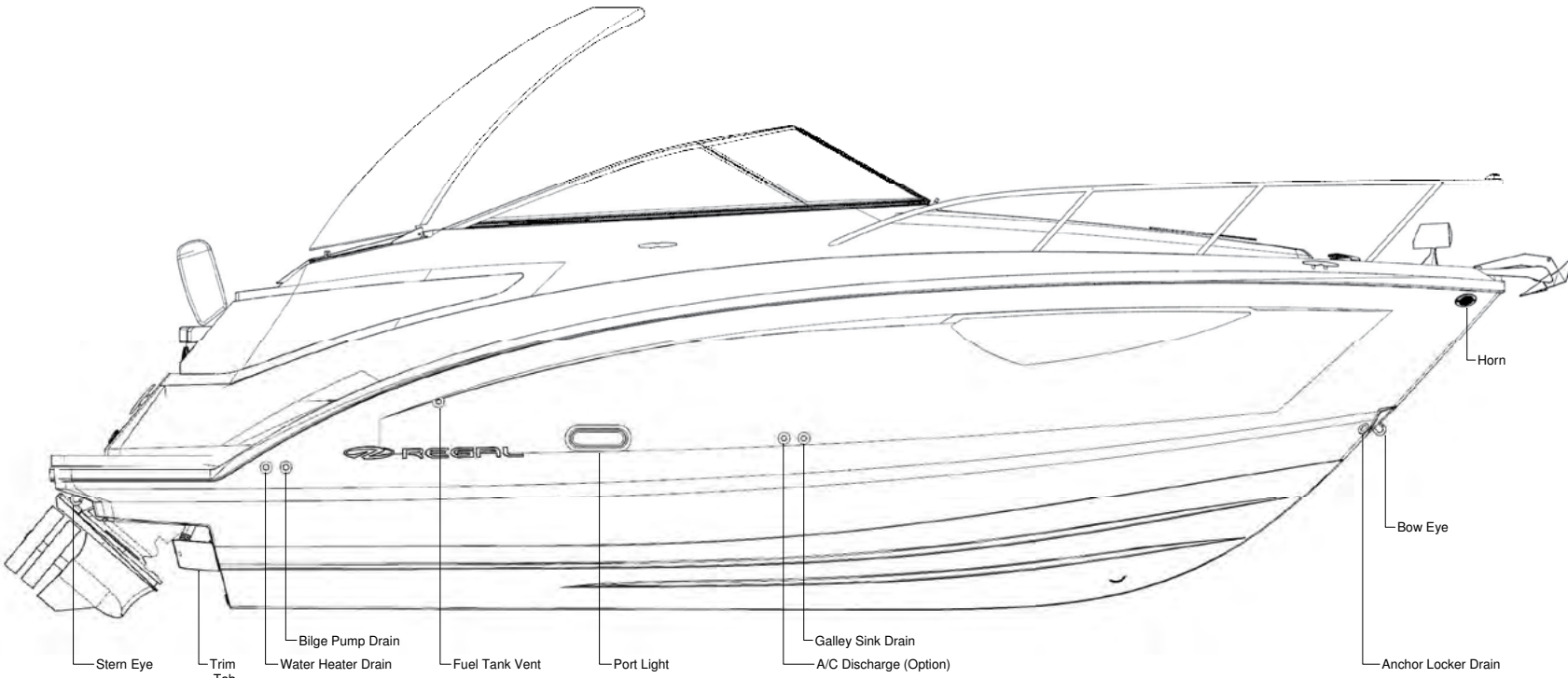

A	Updated thru hole locations Removed Docking Lights	CVL	DR	9/15/15
REV	REVISION DESCRIPTION	DR. BY	APP. BY	REV. DATE

 **REGAL MARINE INDUSTRIES**
 2300 JETPORT DRIVE
 ORLANDO, FLORIDA 32809
 TEL (407) 851-4360 ALL RIGHTS RESERVED

REFERENCE ONLY

PROPRIETARY AND CONFIDENTIAL:
 THE INFORMATION CONTAINED IN THIS DRAWING IS THE SOLE PROPERTY OF REGAL MARINE INDUSTRIES. ANY REPRODUCTION IN PART OR AS WHOLE WITHOUT THE WRITTEN PERMISSION OF REGAL MARINE INDUSTRIES IS PROHIBITED.

DRAWING TITLE: 26 Ex Hull Hardware		
DATE: 9/15/15	REVISION: A	PAGE: 1 OF 2
DRAWN BY: CVL	APPROVED BY: DR	DWG. NO.: 6

Port View

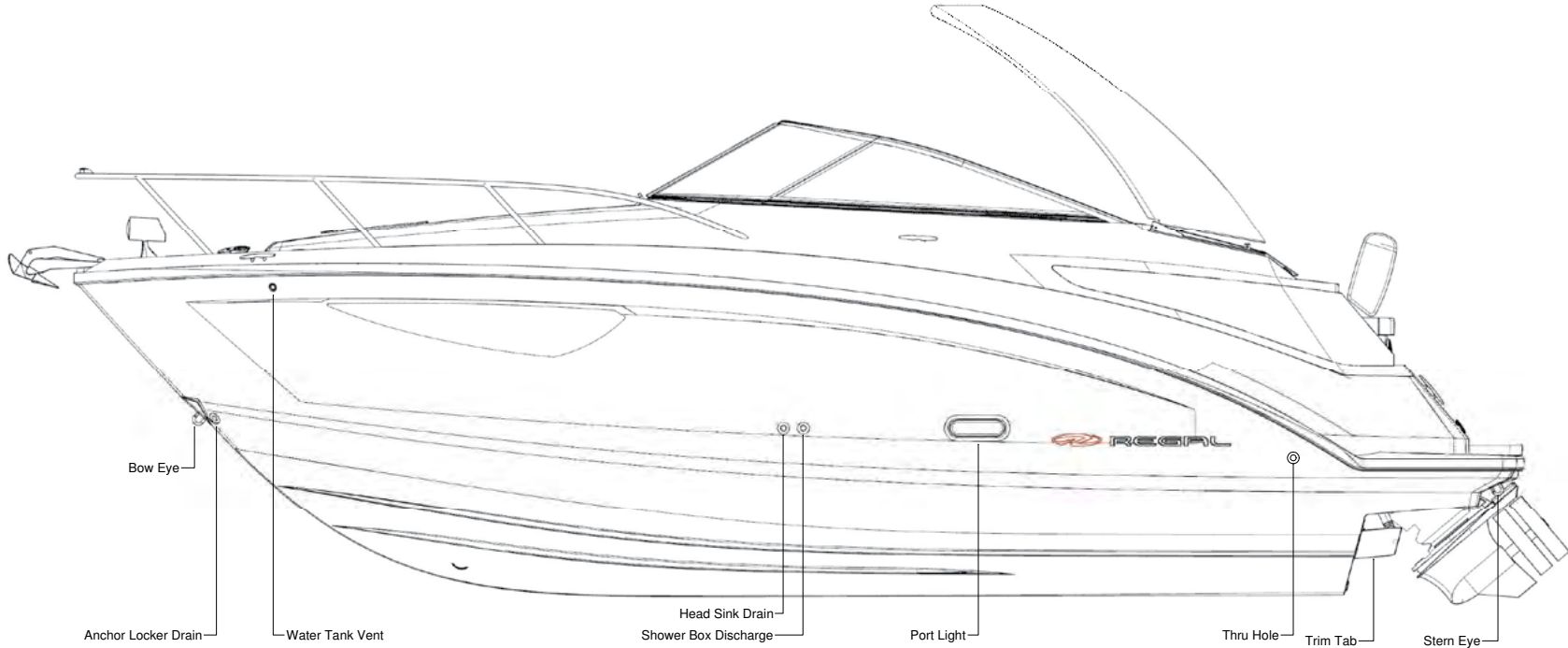

REFERENCE ONLY

PROPRIETARY AND CONFIDENTIAL:
THE INFORMATION CONTAINED IN THIS DRAWING IS THE SOLE PROPERTY OF REGAL MARINE INDUSTRIES. ANY REPRODUCTION IN PART OR AS WHOLE WITHOUT THE WRITTEN PERMISSION OF REGAL MARINE INDUSTRIES IS PROHIBITED.

A	Updated thru hole locations Removed Docking Lights	CVL	DR	9/15/15
REV	REVISION DESCRIPTION	DR. BY	APP. BY	REV. DATE
REGAL MARINE INDUSTRIES <small>2500 JETPORT DRIVE ORLANDO, FLORIDA 32809 TEL (407) 851-4380</small>				
DRAWING TITLE: 26 Ex Hull Hardware				
DATE:	9/15/15	REVISION:	A	PAGE:
DRAWN BY:	CVL	APPROVED BY:	DR	2 OF 2 6

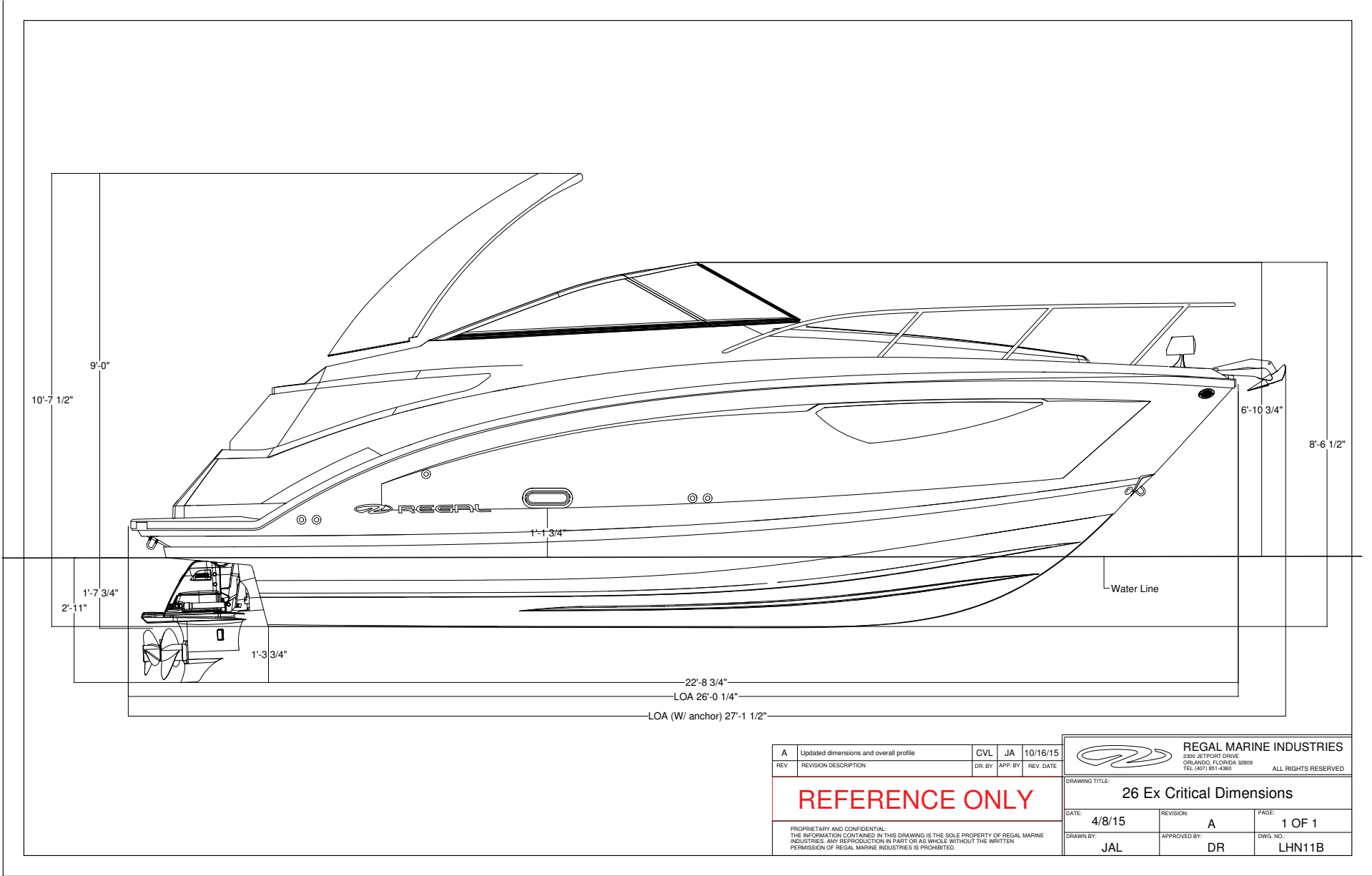

REV	REVISION DESCRIPTION	DR. BY	APP. BY	REV. DATE
A	Updated dimensions and overall profile	CVL	JA	10/16/15

 REGAL MARINE INDUSTRIES 2300 JETPORT DRIVE ORLANDO, FLORIDA 32809 TEL (407) 851-4360			ALL RIGHTS RESERVED
			DRAWING TITLE: 26 Ex Critical Dimensions
DATE: 4/8/15	REVISION: A	PAGE: 1 OF 1	
DRAWN BY: JAL	APPROVED BY: DR	DWG. NO.: LHN11B	

REFERENCE ONLY

PROPRIETARY AND CONFIDENTIAL:
THE INFORMATION CONTAINED IN THIS DRAWING IS THE SOLE PROPERTY OF REGAL MARINE INDUSTRIES. ANY REPRODUCTION IN PART OR AS WHOLE WITHOUT THE WRITTEN PERMISSION OF REGAL MARINE INDUSTRIES IS PROHIBITED.

26 EXPRESS DIMENSIONS (APPROXIMATE)

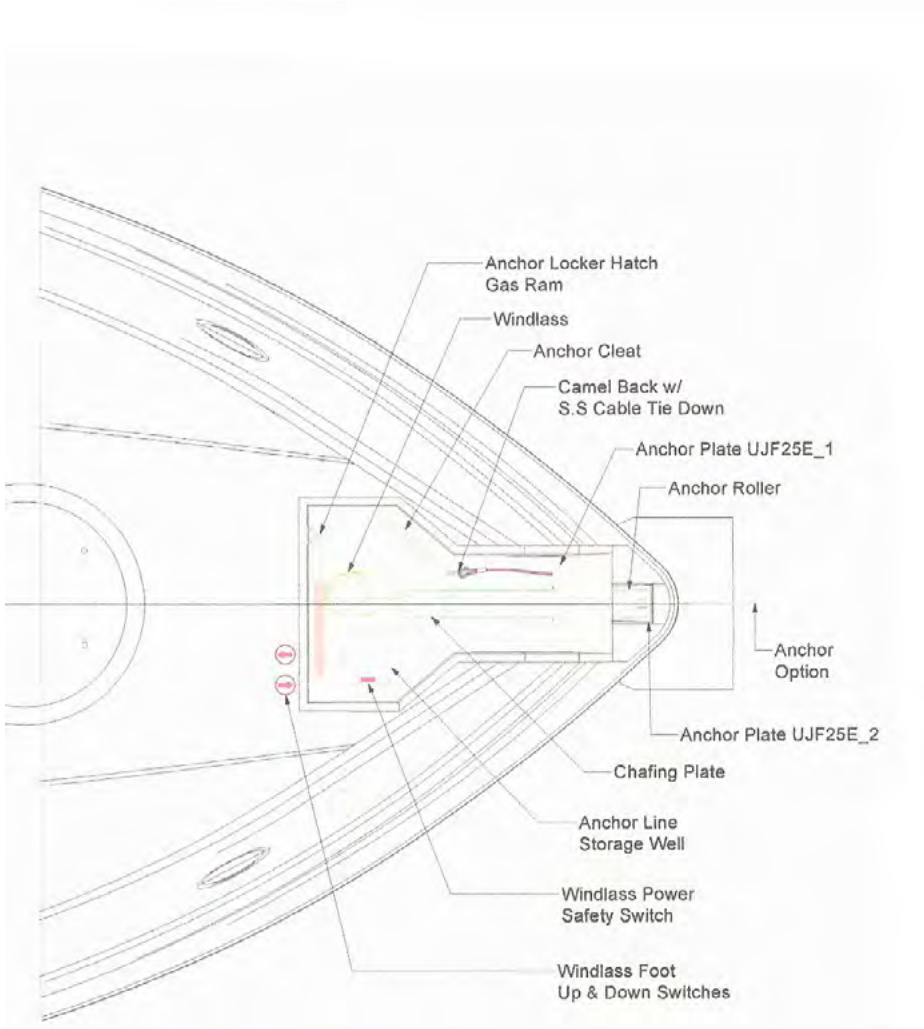

Deck Bow Plan

		REGAL MARINE INDUSTRIES <small>1000 N. W. 10th Ave. Ft. Lauderdale, FL 33304</small> <small>TEL: 954.576.4444 FAX: 954.576.4445</small>	
<small>REGAL MARINE INDUSTRIES ALL RIGHTS RESERVED</small>			
32 Express Windlass Option			
DATE	SCALE	SHEET	
11-13-12	NTS	1-1	
DESIGNED BY	APPROVED BY	DATE PLOTTED	
C.W.	MS	MUF24D	

- KEY
- A. FUEL TANK
 - B. FUEL TANK FILLING POINT
 - C. WATER TANK
 - D. WATER TANK FILLING POINT
 - E. HOLDING TANK
 - F. HOLDING EMPTYING POINT
 - G. SEACOCKS
 - H. THRU-HULL FITTINGS
 - I. AUTOMATIC FIRE EXTINGUISHER
 - J. CARBON MONOXIDE DETECTOR
 - K. ESCAPE HATCH
 - L. ANCHOR STRONG POINT
 - M. TOWING STRONG POINT
 - N. BATTERY SWITCH
 - O. BILGE PUMP

Deck View

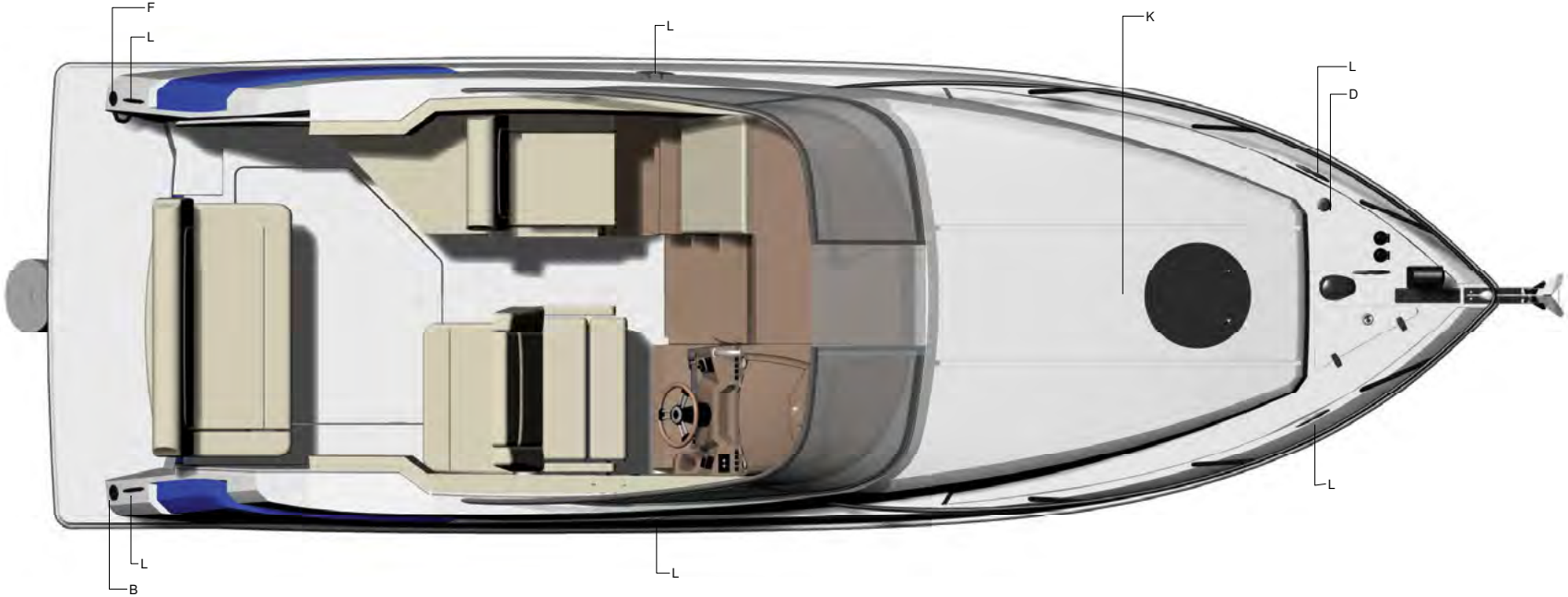

REFERENCE ONLY

PROPRIETARY AND CONFIDENTIAL:
THE INFORMATION CONTAINED IN THIS DRAWING IS THE SOLE PROPERTY OF REGAL MARINE INDUSTRIES. ANY REPRODUCTION IN PART OR AS WHOLE WITHOUT THE WRITTEN PERMISSION OF REGAL MARINE INDUSTRIES IS PROHIBITED.

REGAL MARINE INDUSTRIES <small>2380 JETPORT DRIVE ORLANDO, FLORIDA 32809 TEL (407) 851-4360</small>		
DRAWING TITLE: 26 Ex Component Location		
DATE: 4/8/15	REVISION: -	PAGE: 1 OF 1
DRAWN BY: JAL	APPROVED BY: DR	DWG. NO.: 7

26 EXPRESS DECK COMPONENTS TOP VIEW

Hull View

- KEY
- A. FUEL TANK
 - B. FUEL TANK FILLING POINT
 - C. WATER TANK
 - D. WATER TANK FILLING POINT
 - E. HOLDING TANK
 - F. HOLDING EMPTYING POINT
 - G. SEACOCKS
 - H. THRU-HULL FITTINGS
 - I. AUTOMATIC FIRE EXTINGUISHER
 - J. CARBON MONOXIDE DETECTOR
 - K. ESCAPE HATCH
 - L. ANCHOR STRONG POINT
 - M. TOWING STRONG POINT
 - N. BATTERY SWITCH
 - O. BILGE PUMP

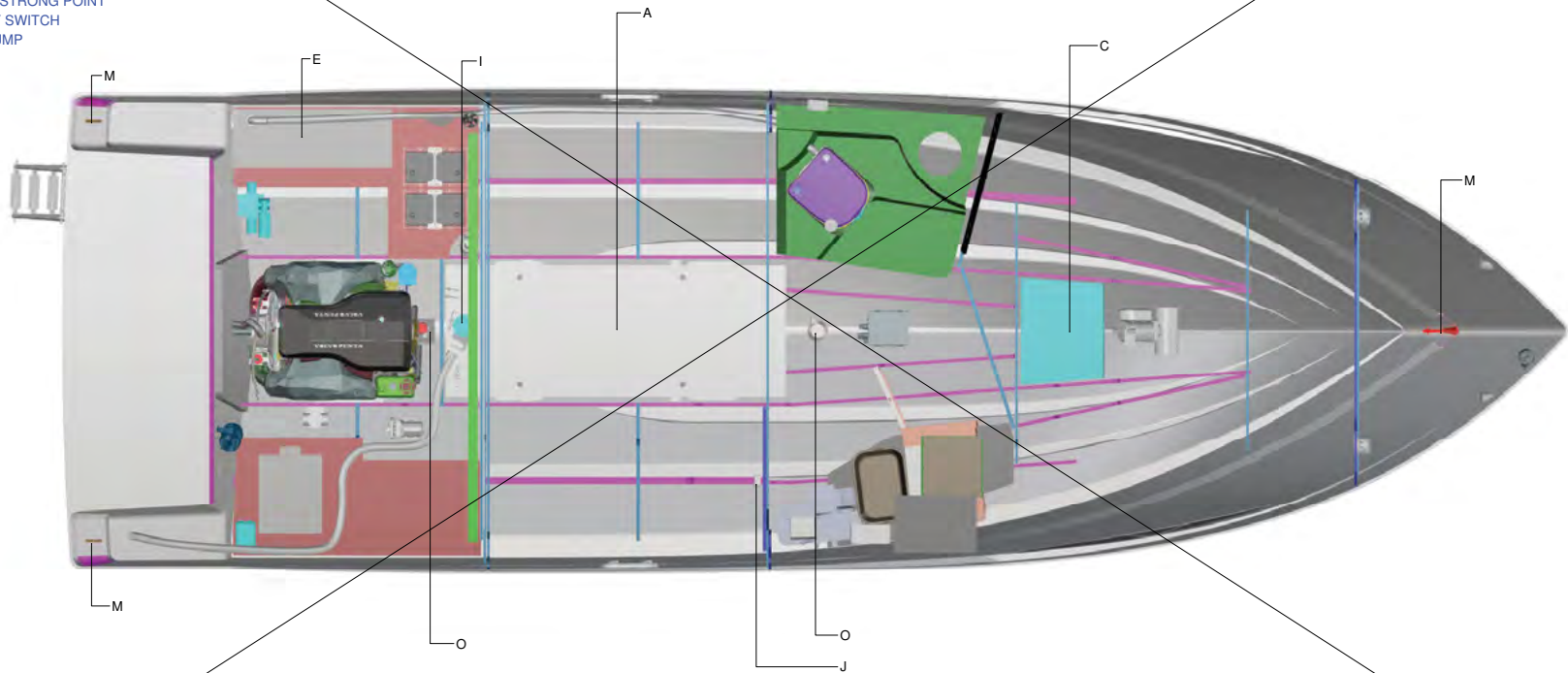

REFERENCE ONLY

PROPRIETARY AND CONFIDENTIAL.
THE INFORMATION CONTAINED IN THIS DRAWING IS THE SOLE PROPERTY OF REGAL MARINE INDUSTRIES. ANY REPRODUCTION IN PART OR AS WHOLE WITHOUT THE WRITTEN PERMISSION OF REGAL MARINE INDUSTRIES IS PROHIBITED.

 REGAL MARINE INDUSTRIES <small>300 JETPORT DRIVE ORLANDO, FLORIDA 32809 TEL (407) 851-4300</small>			<small>ALL RIGHTS RESERVED</small>
DRAWING TITLE: 26 Ex Component Location			
DATE: 4/8/15	REVISION: -	PAGE: 1 OF 1	
DRAWN BY: JAL	APPROVED BY: -	DWG. NO.: 7	

26 EXPRESS HULL COMPONENTS TOP VIEW

15.5"W X 29.5"L Allowance Per Person

SEATING OCCUPANCY= 8 PERSONS

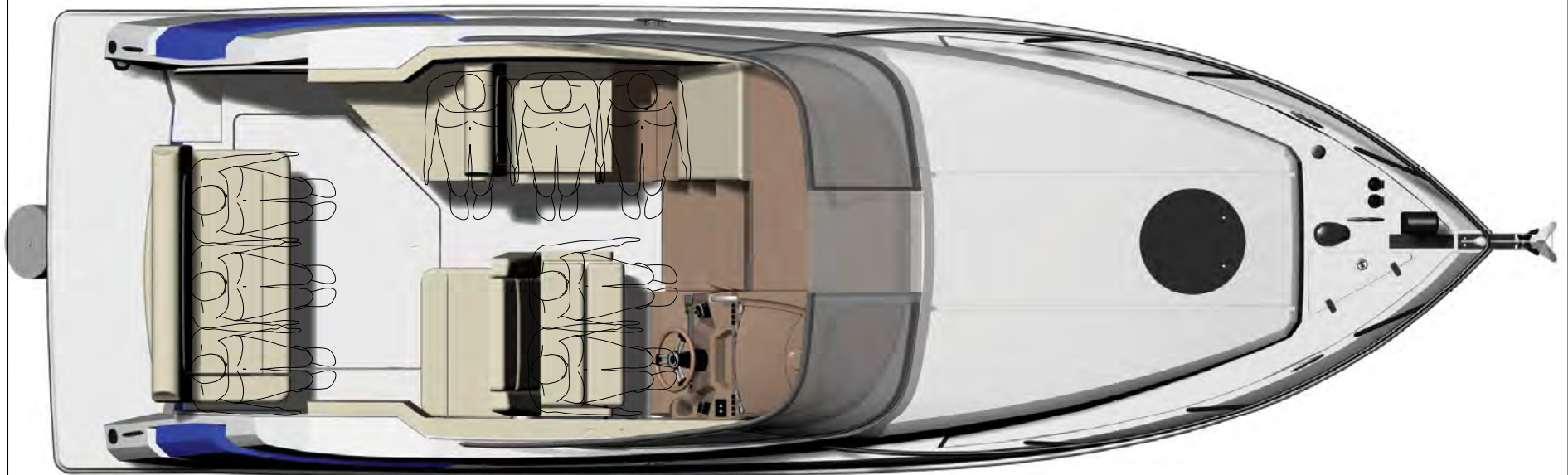
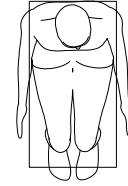

REFERENCE ONLY

PROPRIETARY AND CONFIDENTIAL:
THE INFORMATION CONTAINED IN THIS DRAWING IS THE SOLE PROPERTY OF REGAL MARINE INDUSTRIES. ANY REPRODUCTION IN PART OR AS WHOLE WITHOUT THE WRITTEN PERMISSION OF REGAL MARINE INDUSTRIES IS PROHIBITED.

 REGAL MARINE INDUSTRIES 2300 LETTFOOT DRIVE ORLANDO, FLORIDA 32809 TEL (407) 851-4360		ALL RIGHTS RESERVED	
		DRAWING TITLE: 26 Ex Persons Capacity	
DATE: 4/8/15	REVISION: -	PAGE: 1 OF 1	
DRAWN BY: JAL	APPROVED BY: -	DWG. NO.: 2	

26 EXPRESS PERSONS CAPACITY

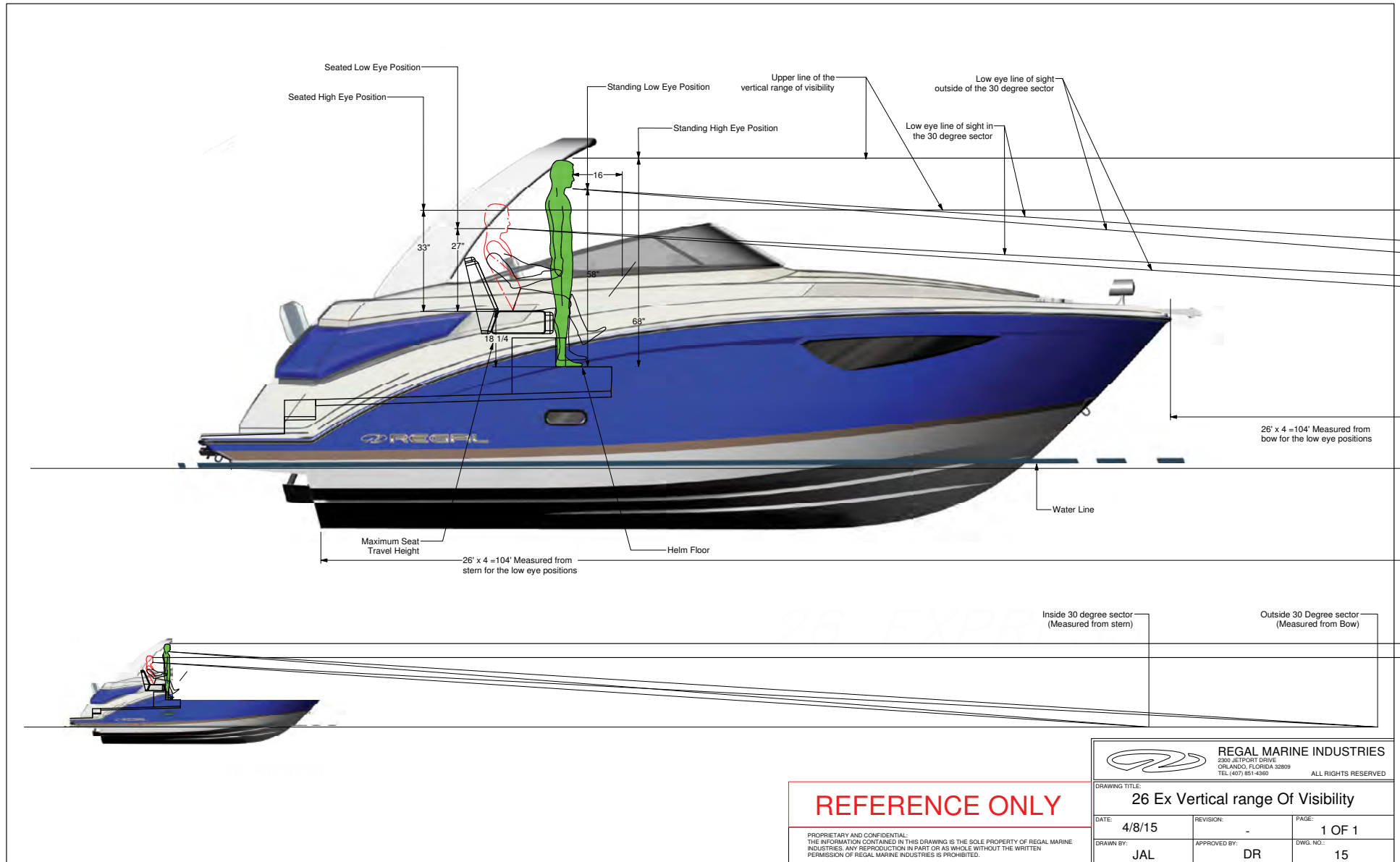

26 EXPRESS RANGE OF VISIBILITY

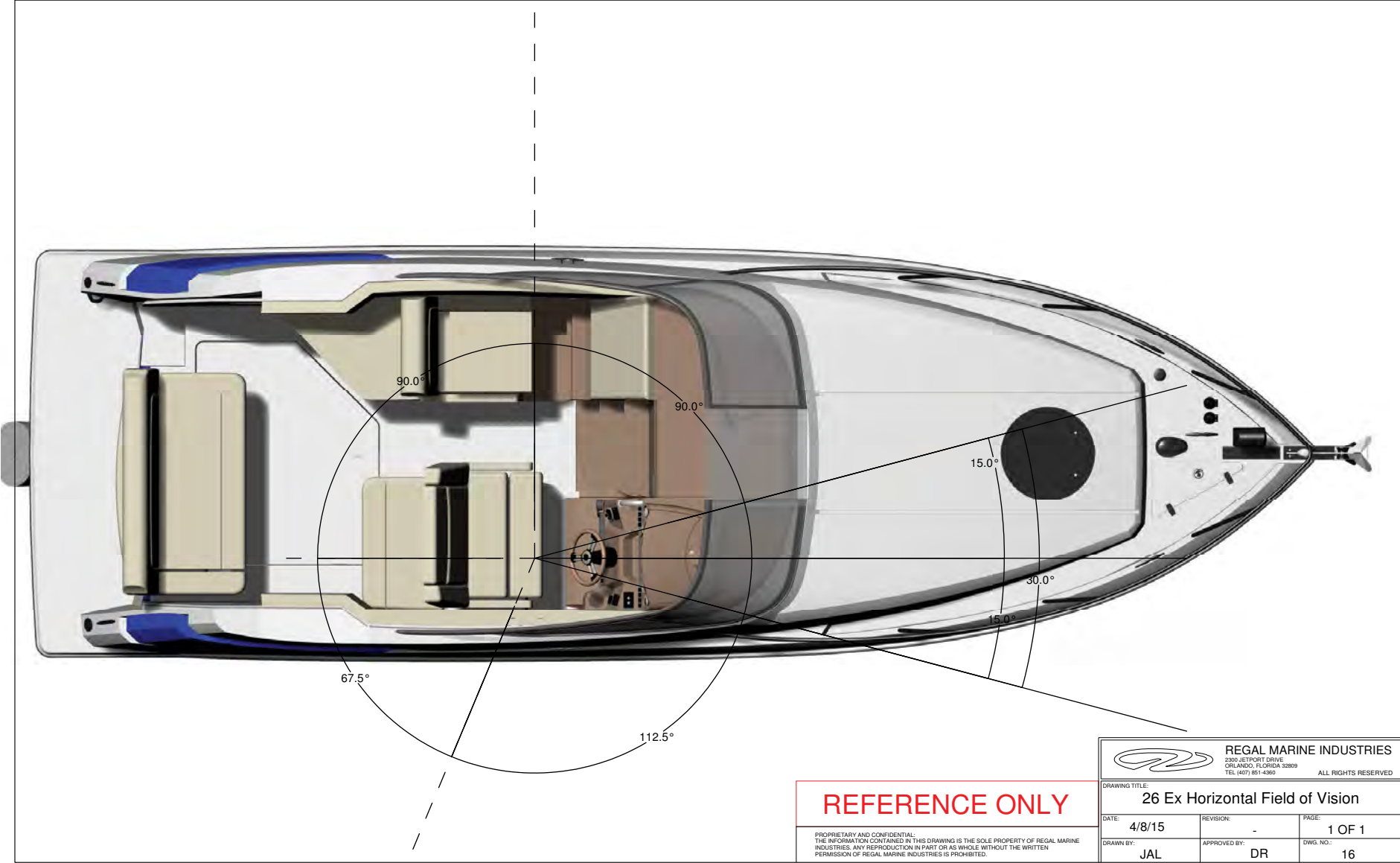

		REGAL MARINE INDUSTRIES 2300 JETPORT DRIVE ORLANDO, FLORIDA 32809 TEL: (407) 651-4300		ALL RIGHTS RESERVED	
		DRAWING TITLE: 26 Ex Horizontal Field of Vision			
DATE:	4/8/15	REVISION:	-	PAGE:	1 OF 1
DRAWN BY:	JAL	APPROVED BY:	DR	DWG. NO.:	16

REFERENCE ONLY

PROPRIETARY AND CONFIDENTIAL:
 THE INFORMATION CONTAINED IN THIS DRAWING IS THE SOLE PROPERTY OF REGAL MARINE INDUSTRIES. ANY REPRODUCTION IN PART OR AS WHOLE WITHOUT THE WRITTEN PERMISSION OF REGAL MARINE INDUSTRIES IS PROHIBITED.

26 EXPRESS RANGE OF VISIBILITY

REV	DESCRIPTION	REVISIONS	DATE	MADE BY	ECN NO.
-----	-------------	-----------	------	---------	---------

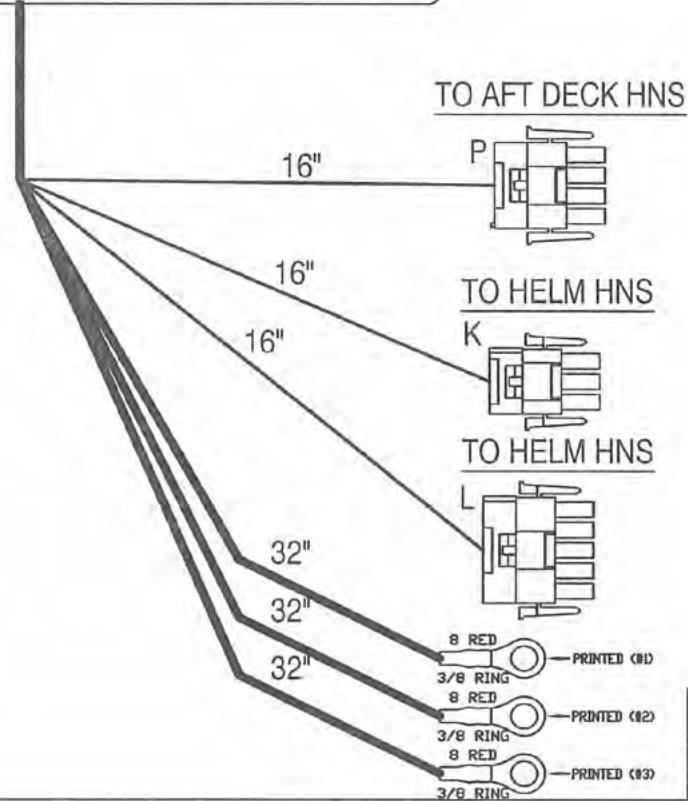
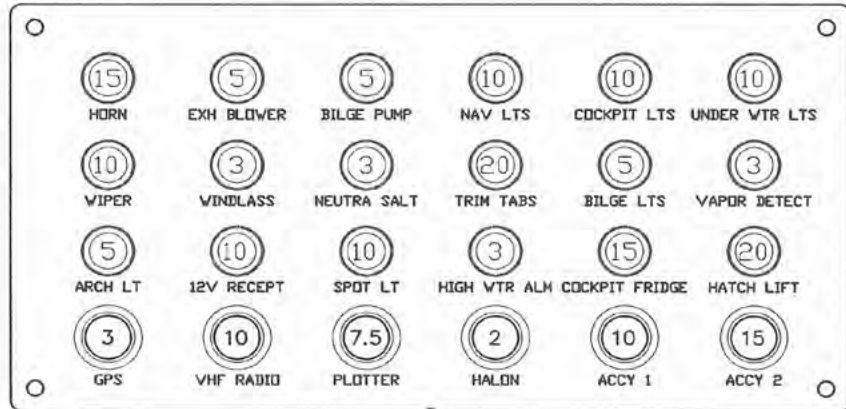

PROPRIETARY RIGHTS
 THIS DOCUMENT CONTAINS UNCLASSIFIED INFORMATION WHICH IS THE PROPERTY OF BHE ELECTRONICS INC. ANY REPRODUCTION OR TRANSMISSION OF THIS INFORMATION WITHOUT THE WRITTEN PERMISSION OF BHE ELECTRONICS INC. IS PROHIBITED. THIS DOCUMENT IS TO BE RETURNED UPON REQUEST TO BHE ELECTRONICS INC.

QTY	P/N	DESCRIPTION
-	-	-
-	-	-
36	420-8EXTSTAR	#8 STARWASHER
12	420-PPMSSSB0C312	8-32 X 5/16 PHIL PAN MS SS
24	420-PPMSSSB0C25	8-32 X 1/4 PHIL PAN MS SS
18	737-10020CLR	CLEAR BREAKER BOOT 3/8-27
2	352-CBCKJ203	BREAKER CMB 20 90 DEG SCR TERM
2	352-CBCKJ153	BREAKER CMB 15 90 DEG SCR TERM
6	352-CBCKJ103	BREAKER CMB 10 90 DEG SCR TERM
4	352-CBCKJ053	BREAKER CMB 5 90 DEG SCR TERM
4	352-CBCKJ033	BREAKER CMB 3 90 DEG SCR TERM
-	-	-
6	437-BUHTB261	GLASS TUBE FUSE CAP & BASE (PNL MT)
1	438-BUSAGC15	15 AMP TUBE GLASS FUSE
2	438-BUSAGC10	10 AMP TUBE GLASS FUSE
1	438-BUSAGC75	7.5 AMP TUBE GLASS FUSE
1	438-BUSAGC03	3 AMP TUBE GLASS FUSE
1	438-BUSAGC02	2 AMP TUBE GLASS FUSE
-	-	-
6	200-01735	COPPER BUSSBAR CC - 1.0625
1	202-01442-A	PIGTAIL
1	200-01733	FACEPLATE

BHE ELECTRONICS
 Regd Part Number
 251850
 Panel Number
 205-02660-A
 Regd Part Number
 281222
 Panel Number
 240-06178-P

DATE	10-15-15
REVISED BY	1/10
DATE	10/29/15
FILE NAME	205-02660-A.DWG
CUSTOMER	REGAL MARINE
MODEL	28 EXPRESS
FRST NAME	HELM
	CIRCUIT BREAKER
	PANEL ASSEMBLY
DWG NO.	205-02660
REV	A

Technical Information

REVISIONS			
REV	DESCRIPTION	DATE	BY

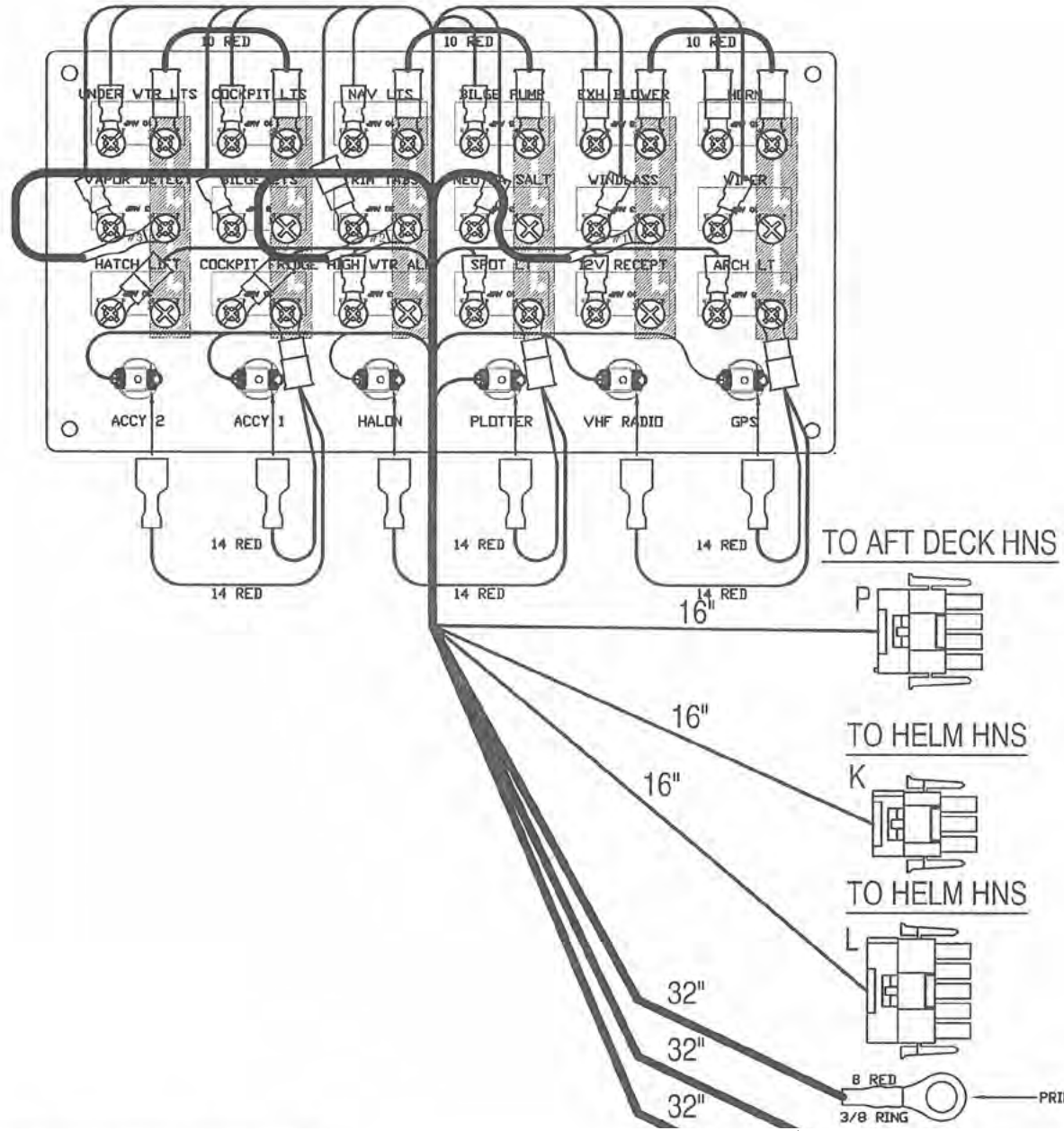

TO HELM HNS

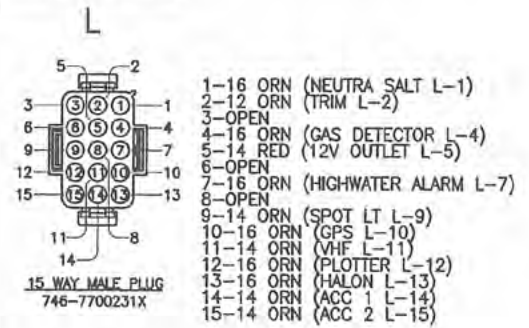

TO HELM HNS

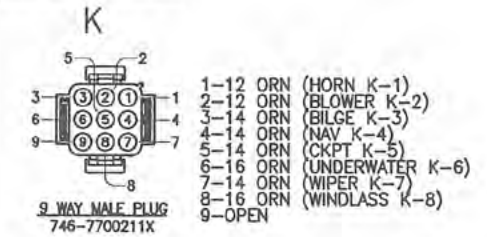

TO AFT DECK HNS



REVISION		DATE	MADE
REV	DESCRIPTION		

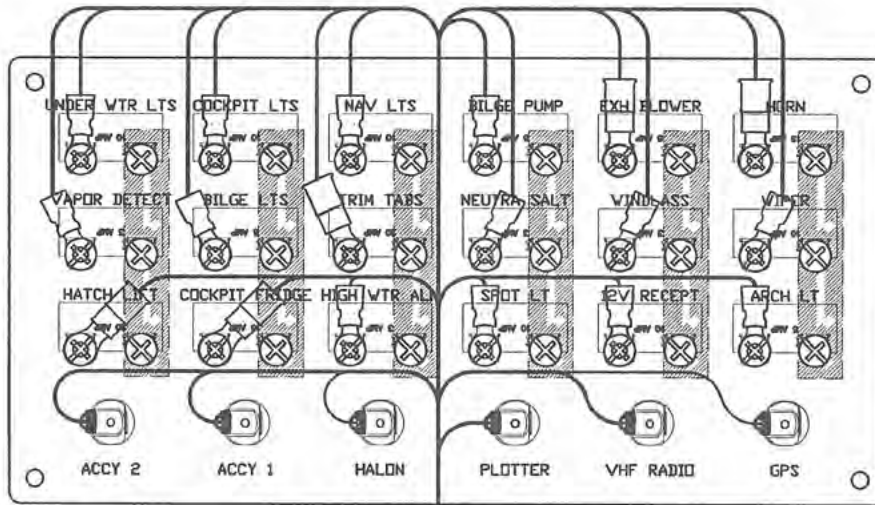

TO HELM HNS

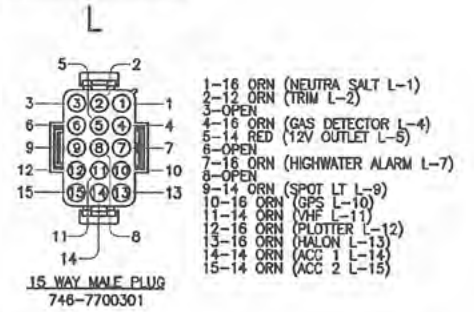

TO HELM HNS

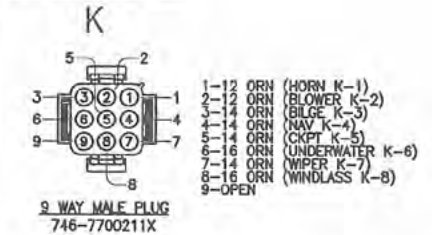

TO AFT DECK HNS

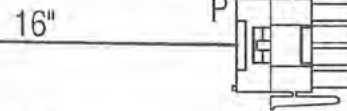

TO HELM HNS

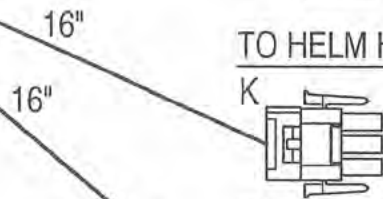

TO HELM HNS

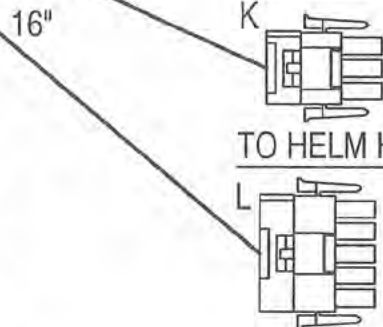

TO AFT DECK HNS

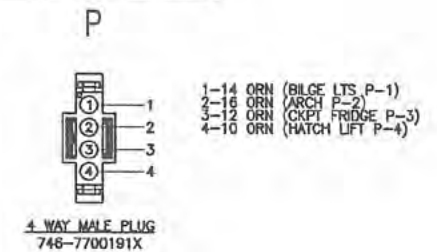

LOAD WIRES

	CUSTOMER	REGAL MARINE
	MODEL	28 EXPRESS

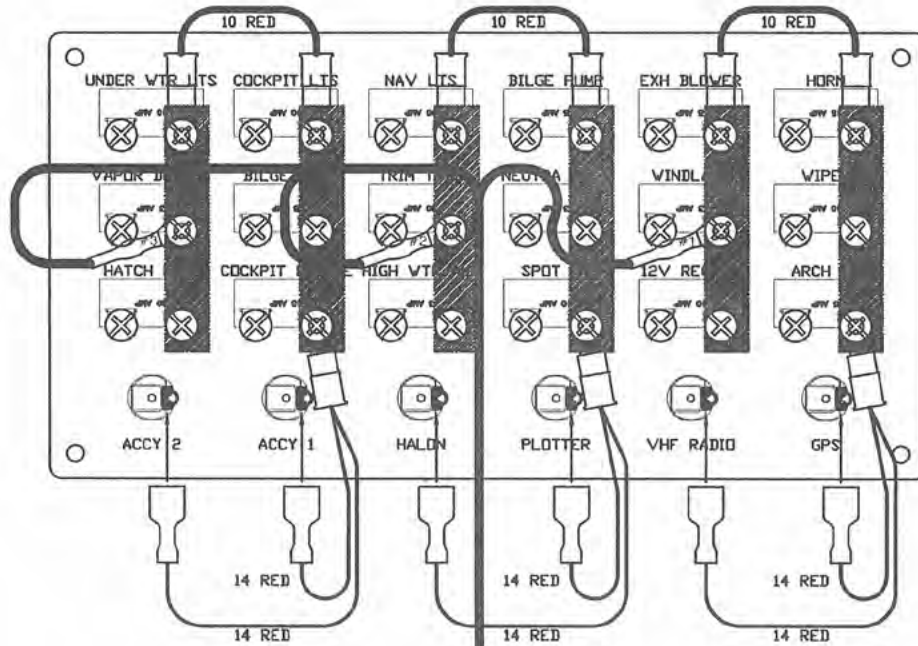

HARDWARE

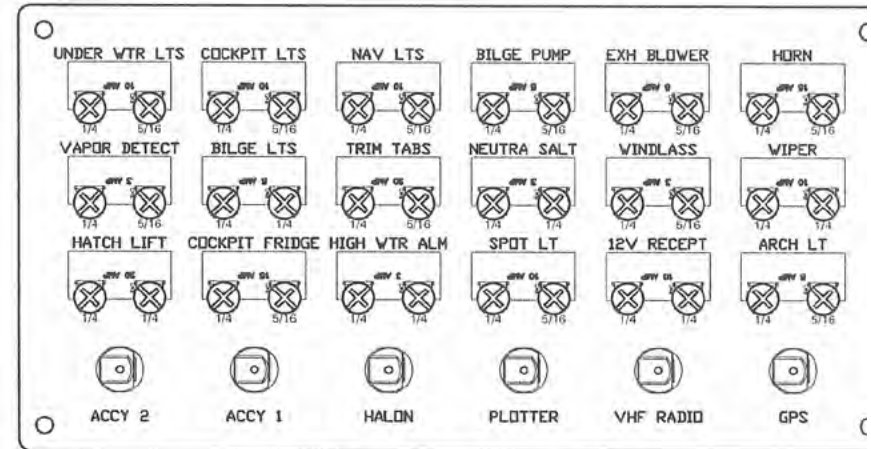

HOT WIRES

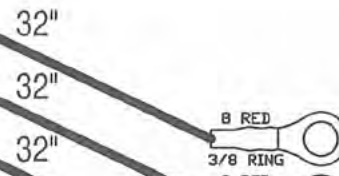

PRINTED (#)

	CUSTOMER	REGAL MARINE
	MODEL	28 EXPRESS

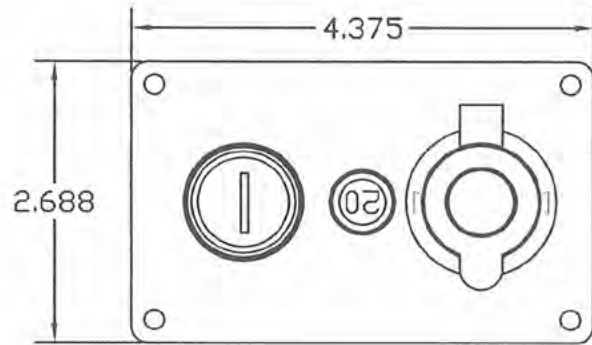

MAIN ACCY HNS

N



2 WAY MALE CAP
746-7700241X

1-14 RED (12V OUTLET N-1)
2-14 BLK (GRD N-2)

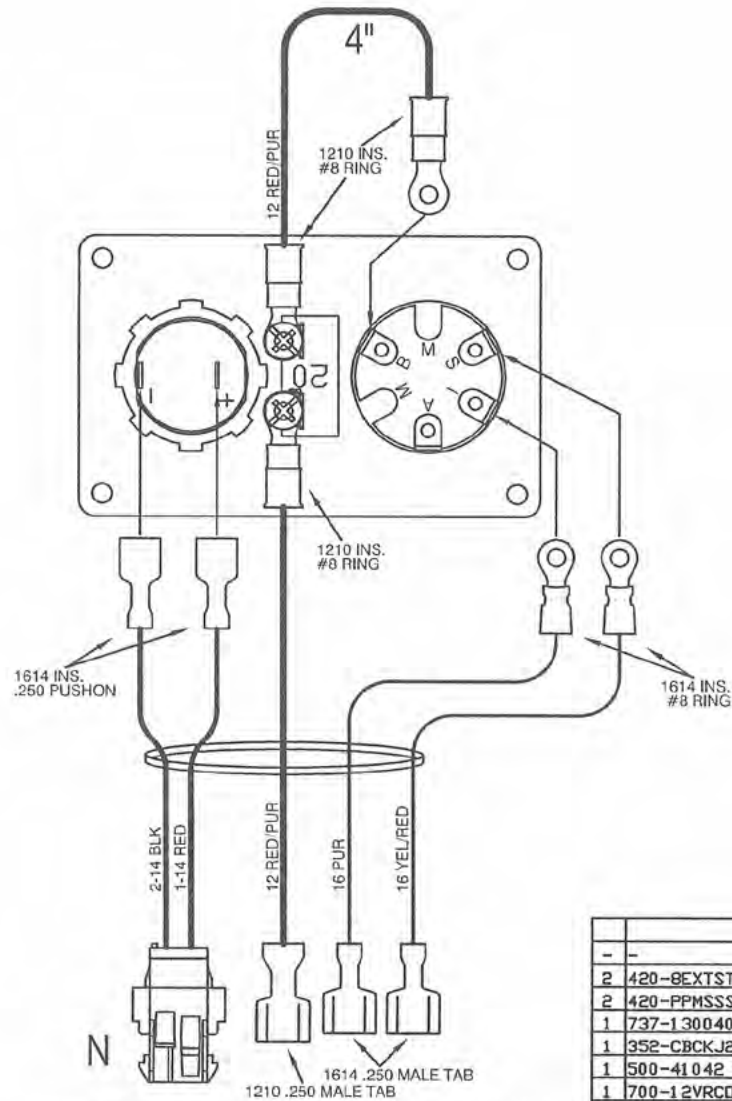

HANGS 6" OFF BACK OF PANEL

QTY	P/N	DESCRIPTION
2	420-8EXTSTAR	#8 STARWASHER
2	420-PPMSSS8C25	8-32 X 1/4 PHIL PAN MS SS
1	737-1300400	BLK BREAKER BOOT 3/8-27
1	352-CBCKJ203	BREAKER CMB 20AMP 90 DEG S
1	500-41042	SWITCH IGNITION W/ACC C SCF
1	700-12VRCOBS	12V RECEPTACLE
1	202-01441-A	PIGTAIL
1	200-01732	FACEPLATE

QTY	P/N	DESCRIPTION
		REGAL MARINE
		28 EXPRESS
		IGNITION
		SWITCH
		PANEL

NOTES

MATERIAL: .090 ALUMINUM
(1) PAINT BLACK

REVISED PART NUMBER
Royal Part Number
281849
Panel Number
205-02658-A
Original Part Number
Royal Part Number

DESIGNED BY
RM
CHECKED BY
JBR
DATE
10-14-15
DATE
11/29/15



Technical Information

NOR POSSESSION THEREOF CONFERS OR TRANSFERS ANY RIGHT TO REPRODUCE, COPY, OR DISCLOSE THE DOCUMENT OR ANY PART THEREOF, ANY INFORMATION CONTAINED THEREIN OR TO CONSTRUCT PANELS OR HARNESSES FROM IT, EXCEPT BY WRITTEN PERMISSION FROM OR WRITTEN AGREEMENT WITH BH ELECTRONICS INC. THIS DOCUMENT IS TO BE RETURNED UPON REQUEST TO BH ELECTRONICS INC.

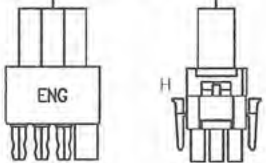
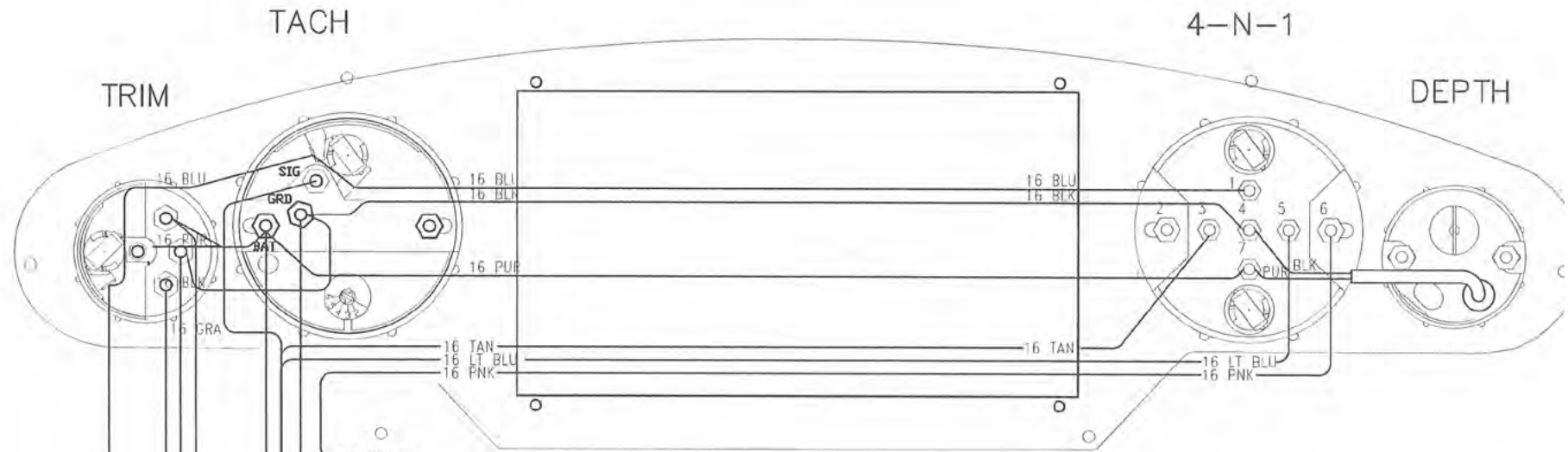

TO ENGINE HNS
PLUG -ENG

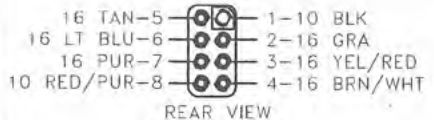

TO MAIN ACC HNS
PLUG -H

- 1- 10 RED/PUR
- 2- 16 PUR
- 3- 16 YEL/RED
- 4- 16 PNK
- 5- 16 BLU
- 6- OPEN
- 7- OPEN
- 8- OPEN

	CUSTOMER	REGAL BOATS
	MODEL	26 EXPRESS
	PRINT NAME	INSTRUMENT PANEL ASSEMBLY W/GARMIN 7607 CUTOUT
	DESIGNED BY JBR	DATE 10/29/15

Technical Information

THIS DOCUMENT DISCLOSES SUBJECT MATTER IN WHICH BH ELECTRONICS INC HAS PROPRIETARY RIGHTS. THE INFORMATION AND DESIGN HEREIN WERE OBTAINED BY AND ARE THE PROPERTY OF BH ELECTRONICS INC. NEITHER RECEIPT NOR POSSESSION THEREOF CONFERS OR TRANSFERS ANY RIGHT TO REPRODUCE, COPY, OR DISCLOSE THE DOCUMENT OR ANY PART THEREOF, ANY INFORMATION CONTAINED THEREIN OR TO CONSTRUCT PANELS OR HARNESSES FROM IT, EXCEPT BY WRITTEN PERMISSION FROM OR WRITTEN AGREEMENT WITH BH ELECTRONICS INC. THIS DOCUMENT IS TO BE RETURNED UPON REQUEST TO BH ELECTRONICS INC.

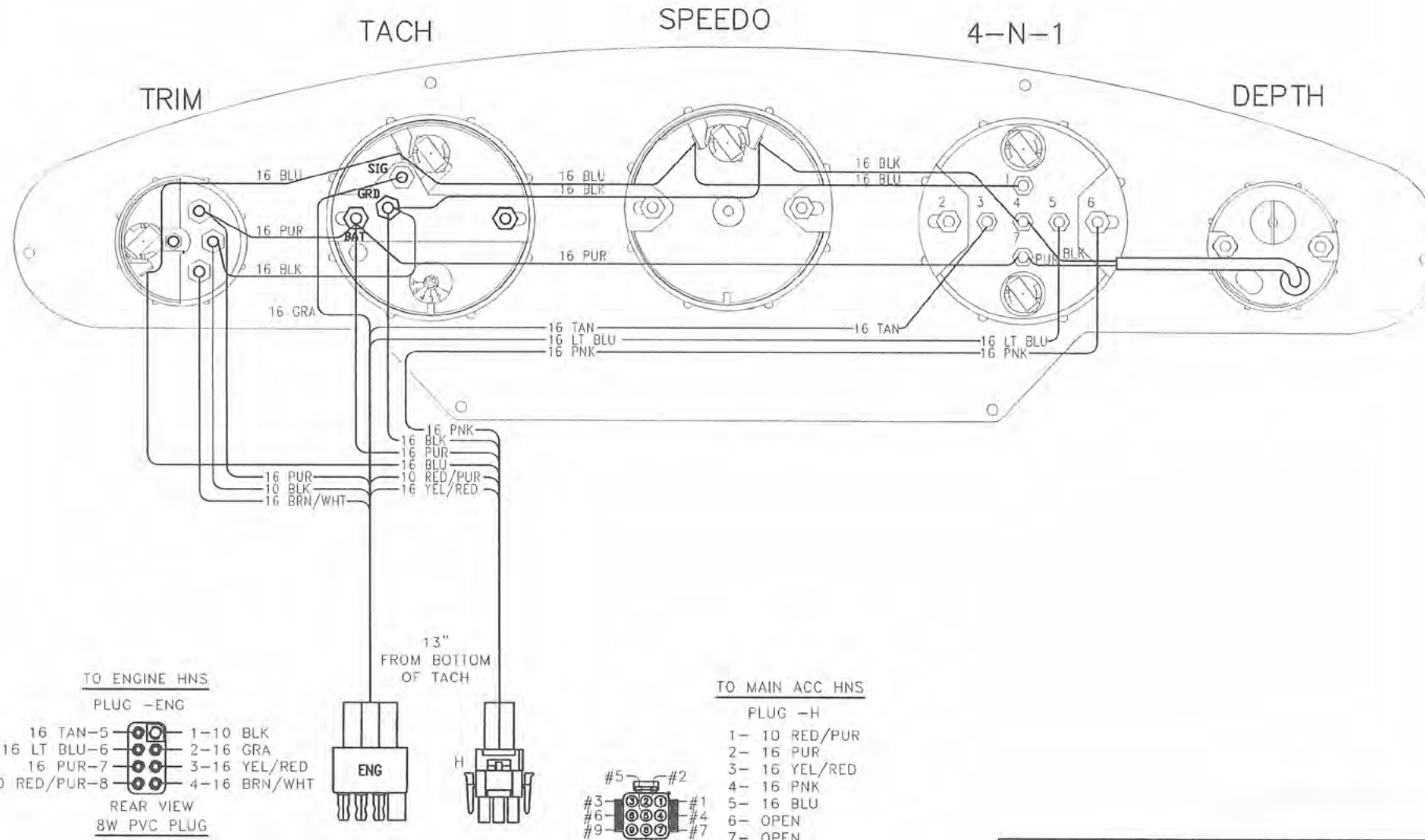

TO ENGINE HNS
 PLUG -ENG

16 TAN-5	1-10 BLK
16 LT BLU-6	2-16 GRA
16 PUR-7	3-16 YEL/RED
10 RED/PUR-8	4-16 BRN/WHT

REAR VIEW
 8W PVC PLUG

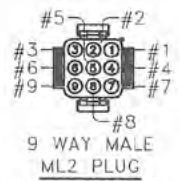
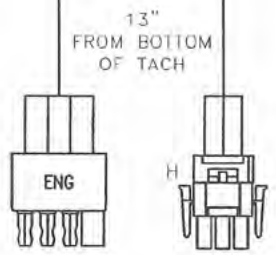

TO MAIN ACC HNS
 PLUG -H

1- 10 RED/PUR
2- 16 PUR
3- 16 YEL/RED
4- 16 PNK
5- 16 BLU
6- OPEN
7- OPEN
8- OPEN
9- 16 BLK

	CUSTOMER	REGAL BOATS
	MODEL	26 EXPRESS
	PART NAME	INSTRUMENT PANEL ASSEMBLY

Technical Information

REVISIONS		DATE	MADE BY	DRW NO.
REV	DESCRIPTION			
-	REVISED BREAKOUT LENGTHS FOR MARK JOURNEY	10-20-15	JRM	-

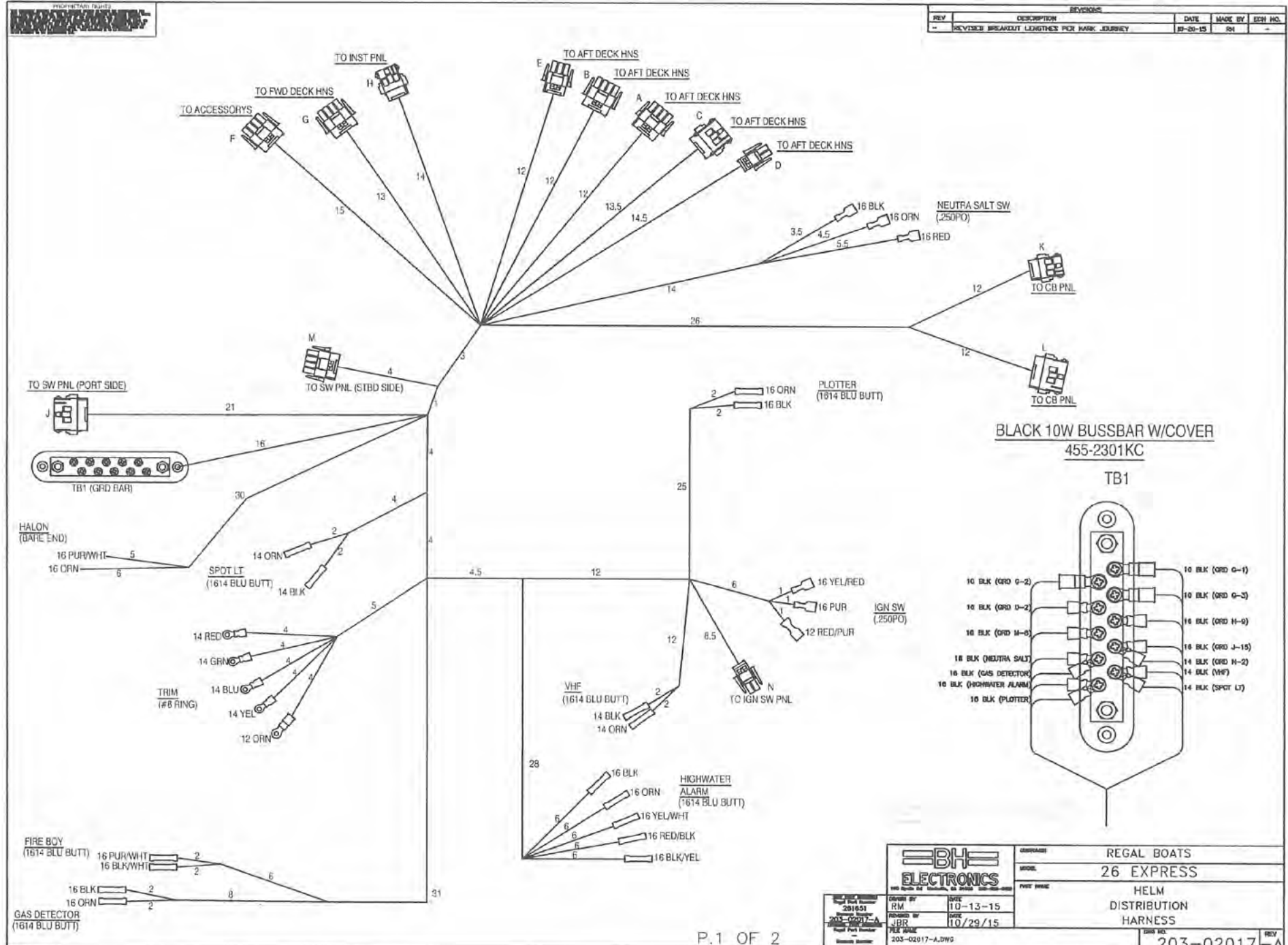

EBH ELECTRONICS		COMPANY: REGAL BOATS
DATE: 10-13-15		MODEL: 26 EXPRESS
DATE: 10/29/15		PART NAME: HELM DISTRIBUTION HARNESS
DESIGNED BY: JBR	DATE: 10/29/15	DRW NO: 203-02017-A
FILE NAME: 203-02017-A.DWG		REV: -A

TO CB PANEL

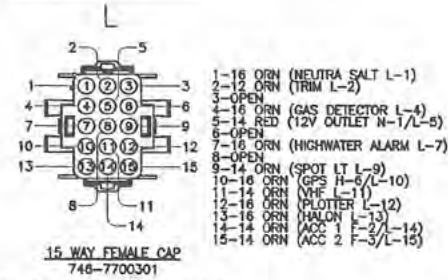

TO CB PANEL

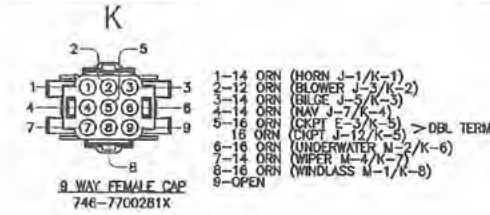

SW PANEL (PORT SIDE)

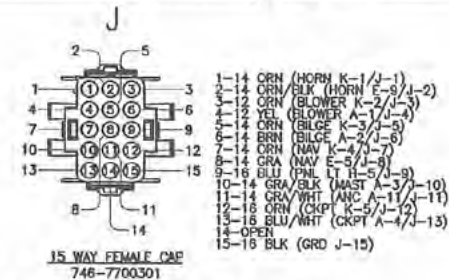

REV	DESCRIPTION	DATE	MADE BY	QCN NO.
1	REV PAGE 1			

TO AFT DECK HNS

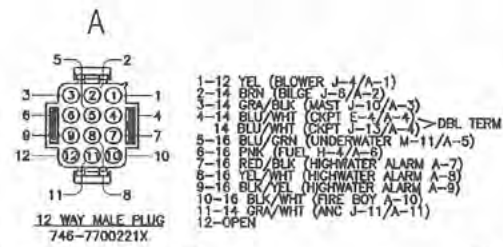

TO INST PANEL

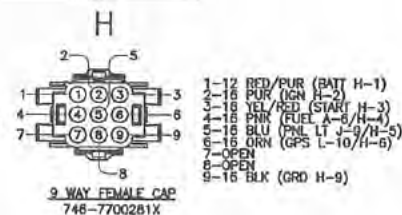

SW PANEL (STBD SIDE)

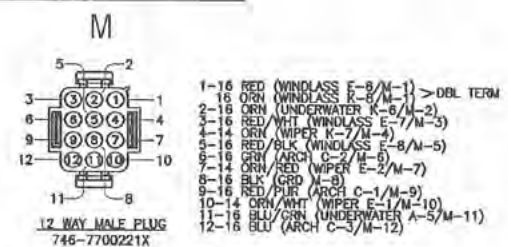

TO ACCESSORYS

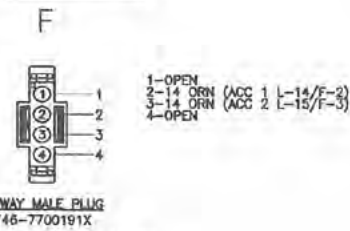

TO FWD DECK HNS

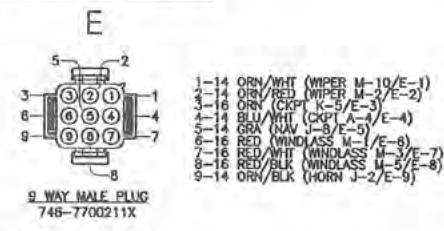

TO FWD DECK HNS

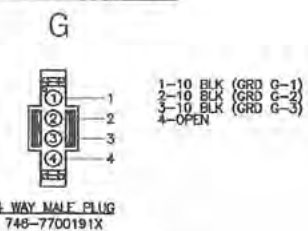

TO AFT DECK HNS

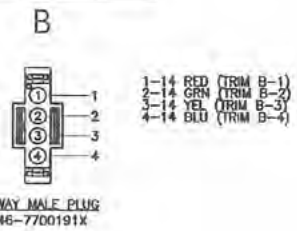

TO AFT DECK HNS

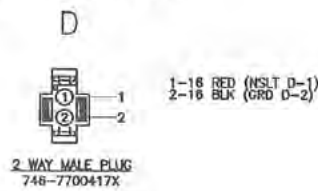

TO AFT DECK HNS

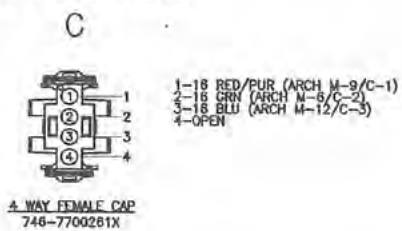

IGN SW PANEL

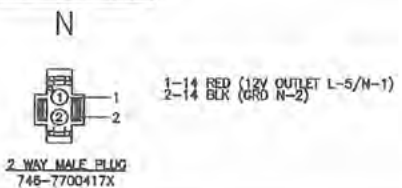

	CUSTOMER:	REGAL BOATS
	MODEL:	26 EXPRESS
	PART NAME:	HELM DISTRIBUTION HARNESS
	DATE:	10-15-15
DESIGNED BY:	RJM	
REVISED BY:	JBR	10/29/15
DATE:		
REV:		

Technical Information

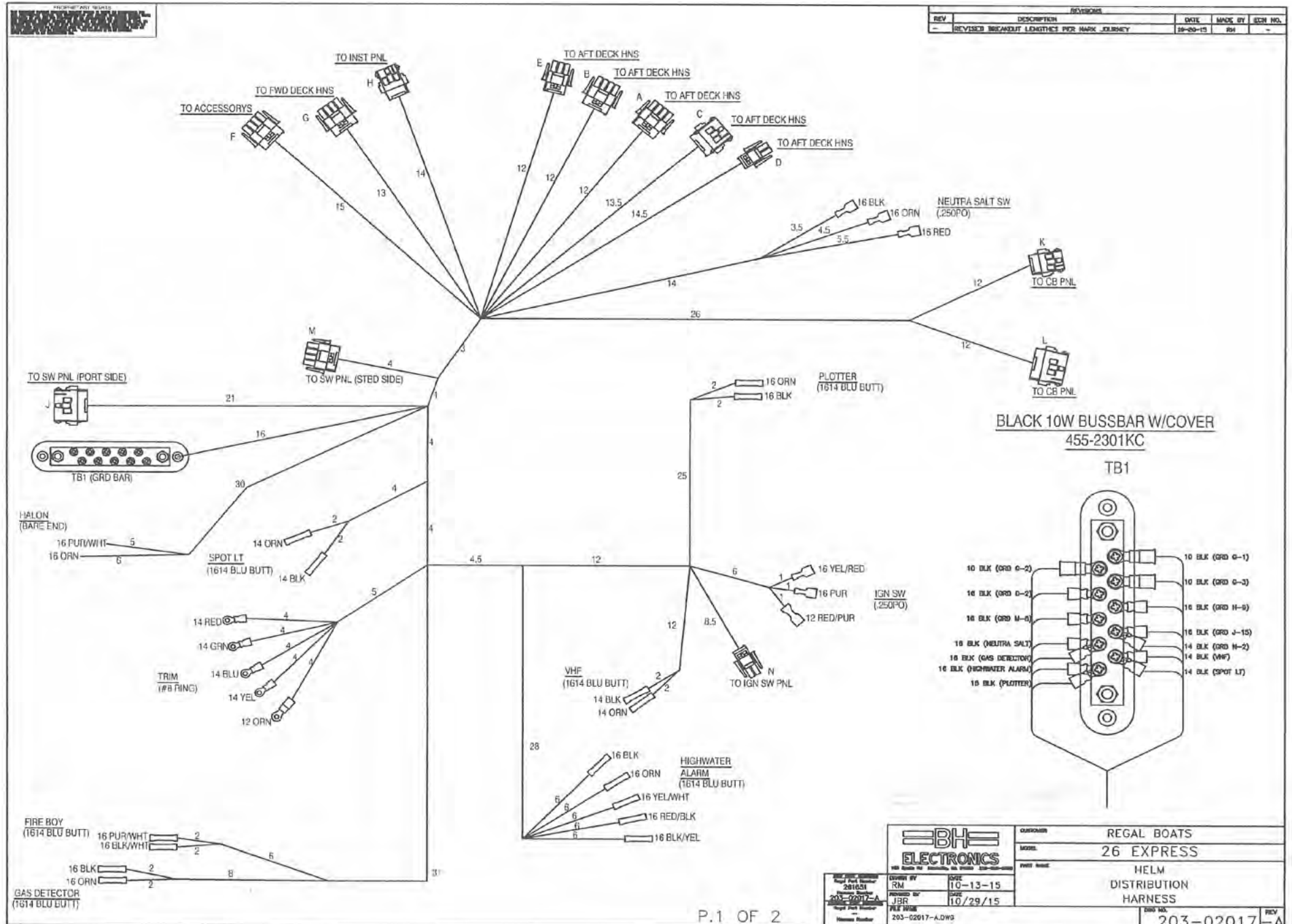

	OUTBOARD REGAL BOATS
	MODEL 26 EXPRESS
	PART NAME HELM DISTRIBUTION HARNESS
DESIGN BY RM	DATE 10-13-15
DESIGNED BY JBR	DATE 10/29/15
FILE NO. 203-02017-A	DRN NO. 203-02017-A.DWG

PROPRIETARY RIGHTS
 THIS DOCUMENT DRAWING DISCLOSES SUBJECT MATTER IN WHICH EH ELECTRONICS INC HAS PROPRIETARY RIGHTS. THE INFORMATION AND DESIGN DISCLOSED HEREIN WERE ORIGINATED BY AND ARE THE PROPERTY OF EH ELECTRONICS INC. NEITHER RECEIPT NOR POSSESSION THEREOF CONVEYS OR TRANSFERS ANY RIGHT TO REPRODUCE, COPY, OR DISCLOSE THE DOCUMENT OR ANY PART THEREOF, ANY INFORMATION CONTAINED THEREIN OR TO CONSTRUCT PANELS OR WIRESSES FROM IT, EXCEPT BY WRITTEN PERMISSION FROM OR WRITTEN AGREEMENT WITH EH ELECTRONICS INC. THIS DOCUMENT IS TO BE RETURNED UPON REQUEST TO EH ELECTRONICS INC.

REV	DESCRIPTION	DATE	MADE BY	ECN NO.
-----	-------------	------	---------	---------

POTTED TERMINAL SWITCHES.

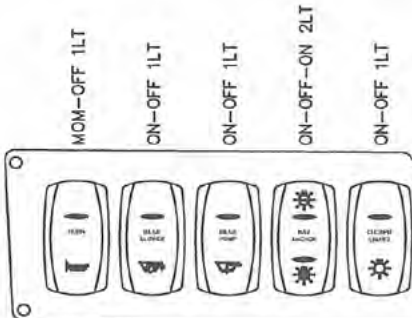

POTTED TERMINAL SWITCHES.

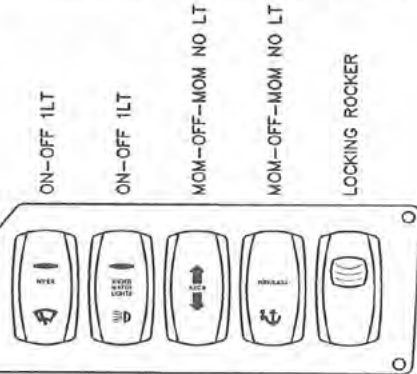

NOTES

- MATERIAL: .090 ALUMINUM
 (1) PAINT BLACK
 (2) CLEARCOAT

-	-	-
-	-	-
-	-	-
5'	740-N606G001	GREY PAPER PVC TAPE
1	737-VVGZCVIND	ACT WINDLASS
1	737-VVGZCARCH	ACT ARCH
1	737-VVGMXXUL	ACT UNDER WATER LIGHTS
1	737-VVGMXXVP	ACT WIPER
1	737-VVGMCKLT	ACT COCKPIT LIGHTS
1	737-VVGMNVAN	ACT NAV / ANCHOR
1	737-VVGMXXBP	ACT BILGE PUMP
1	737-VVGMXXBB	ACT BILGE BLOWER
1	737-VVGMCHDRN	ACT HORN
1	737-V1D2SV0B	SW/ACT SPST LOCKING ON-OFF NOM LIT
2	737-V8D2S00B	SW SPDT (DN)-OFF-(DN) NOM LIT
1	737-V2D2B60B	SW SPST (DN)-OFF LTD
1	737-VJDK66B	SW DPDT ON-OFF-ON LTD
5	737-V1D2B60B	SW SPST ON OFF LTD
1	202-01444-A	STBD PIGTAIL
1	202-01443-A	PORT PIGTAIL
1	200-01734	FACEPLATE
QTY	P/N	DESCRIPTION
		REGAL BOATS
		28 EXPRESS
		SWITCH PANEL ASSEMBLY W/GAUGES

EH ELECTRONICS
 Regal Part Number: 261648
 Panel Number: 205-02661-A
 Printed by: JBR
 Date: 10/29/15
 Regal Part Number: 211334
 Panel Number: 200-08177-P

EH ELECTRONICS
 211 South St. Westfield, MA 01093
 ORDER BY: JBR
 DATE: 10/15/15
 QUOTE BY: JBR
 DATE: 10/29/15
 FILE NAME: 200-02661-ALDND

205-02661 A

Technical Information

PROPRIETARY RIGHTS
 THIS DOCUMENT DRAWING DISCLOSES SUBJECT MATTER IN WHICH BH ELECTRONICS INC HAS PROPRIETARY RIGHTS. THE INFORMATION AND DESIGN DISCLOSED HEREIN WERE ORIGINATED BY AND ARE THE PROPERTY OF BH ELECTRONICS INC. NEITHER RECEIPT NOR POSSESSION THEREOF CONFERS OR TRANSFERS ANY RIGHT TO REPRODUCE, COPY, OR DISCLOSE THE DOCUMENT OR ANY PART THEREOF. ANY INFORMATION OBTAINED THEREON OR TO CONSTRUCT PANELS OR HARNESSES FROM IT, EXCEPT BY WRITTEN PERMISSION FROM OR WRITTEN AGREEMENT WITH BH ELECTRONICS INC. THIS DOCUMENT IS TO BE RETURNED UPON REQUEST TO BH ELECTRONICS INC.

REV	DESCRIPTION	REVISIONS	DATE	MADE BY	ECN NO.

POTTED TERMINAL SWITCHES.

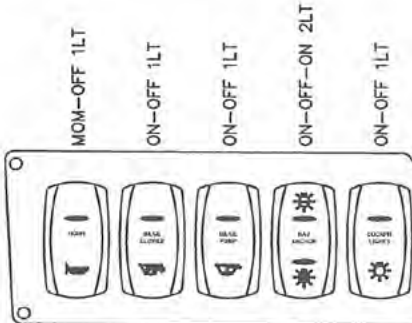

POTTED TERMINAL SWITCHES.

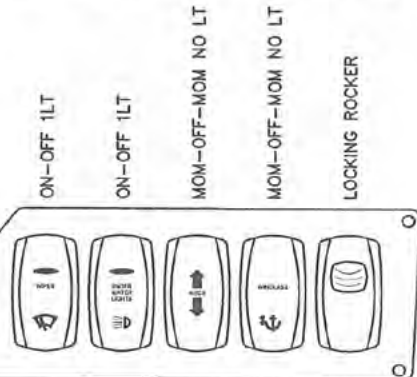

NOTES
 MATERIAL: .090 ALUMINUM
 (1) PAINT BLACK
 (2) CLEARCOAT

5'	740-N606G001	GREY PAPER PVC TAPE
1	737-VYGZCVIND	ACT WINDLASS
1	737-VYGZCARCH	ACT ARCH
1	737-VVGMXXUL	ACT UNDER WATER LIGHTS
1	737-VVGMXXVP	ACT WIPER
1	737-VVGMCKLT	ACT COCKPIT LIGHTS
1	737-VVGMCNVAN	ACT NAV / ANCHOR
1	737-VVGMXXBP	ACT BILGE PUMP
1	737-VVGMXXBB	ACT BILGE BLOWER
1	737-VVGMCHDRN	ACT HORN
1	737-V1D2SV0B	SW/ACT SPST LOCKING ON-OFF NON LIT
2	737-V8D2S00B	SW SPDT <DN>-OFF-<DN> NON LIT
1	737-V2D2B60B	SW SPST <DN>-OFF LTD
1	737-VJDKD66B	SW DPDT ON-OFF-ON LTD
5	737-V1D2B60B	SW SPST ON OFF LTD
1	202-01444-A	STBD PIGTAIL
1	202-01443-A	PORT PIGTAIL
1	200-01734	FACEPLATE
QTY	P/N	DESCRIPTION
		REGAL BOATS
		28 EXPRESS
		SWITCH PANEL ASSEMBLY W/GAUGES

BH ELECTRONICS
 101 South St. Fairport, NY 11731
 607-326-1100
 607-326-1101
 607-326-1102

Drawn by: JBR Date: 10/15/15
 Checked by: JBR Date: 10/29/15
 Royal Port Number: 211334
 Panel Number: 240-08177-P
 200-02661-A1370

205-02661 A

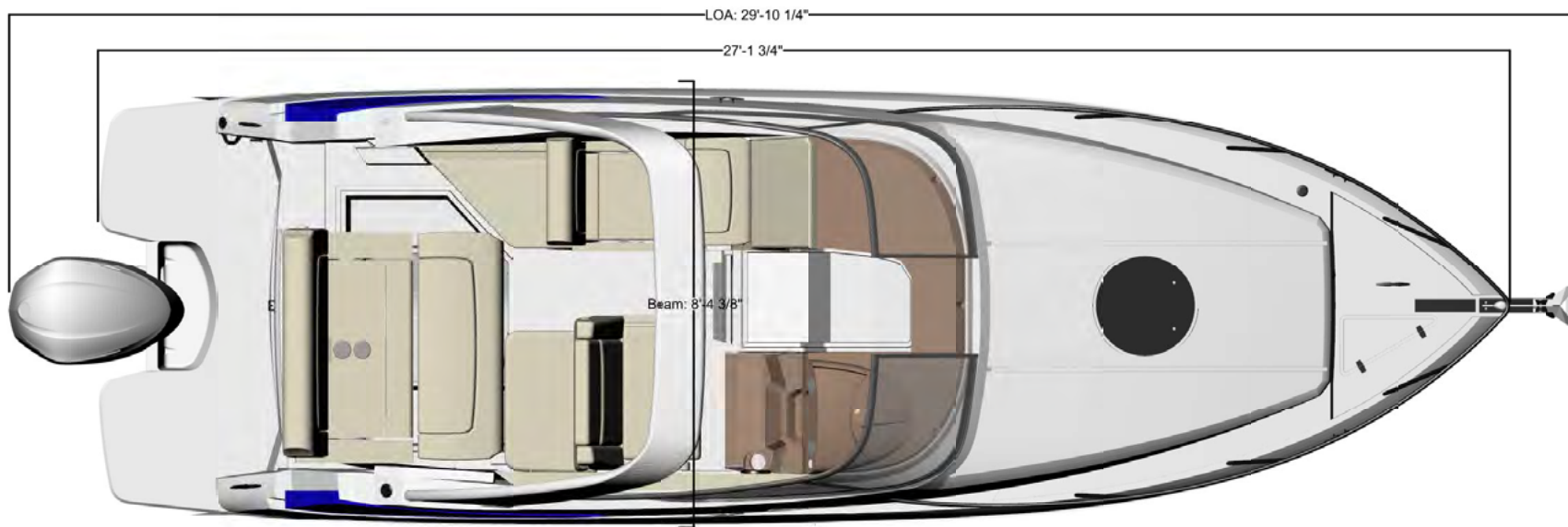



PROPRIETARY AND CONFIDENTIAL:
 THE INFORMATION CONTAINED IN THIS DRAWING IS THE SOLE PROPERTY OF REGAL MARINE INDUSTRIES. ANY REPRODUCTION IN PART OR AS A WHOLE WITHOUT THE WRITTEN PERMISSION OF REGAL MARINE INDUSTRIES IS PROHIBITED.

 REGAL MARINE INDUSTRIES 2300 JETPORT DRIVE ORLANDO, FLORIDA 32809 TEL: (407) 981-4300		
ALL RIGHTS RESERVED		
DRAWING TITLE: 26 XO (HP) Deck Plan		
DATE:	REVISION:	PAGE:
11/20/15	0	1 OF 1
DRAWN BY:	APPROVED BY:	DWG. NO.:
JAL	DR	1

15.5"W X 29.5"L Allowance Per Person

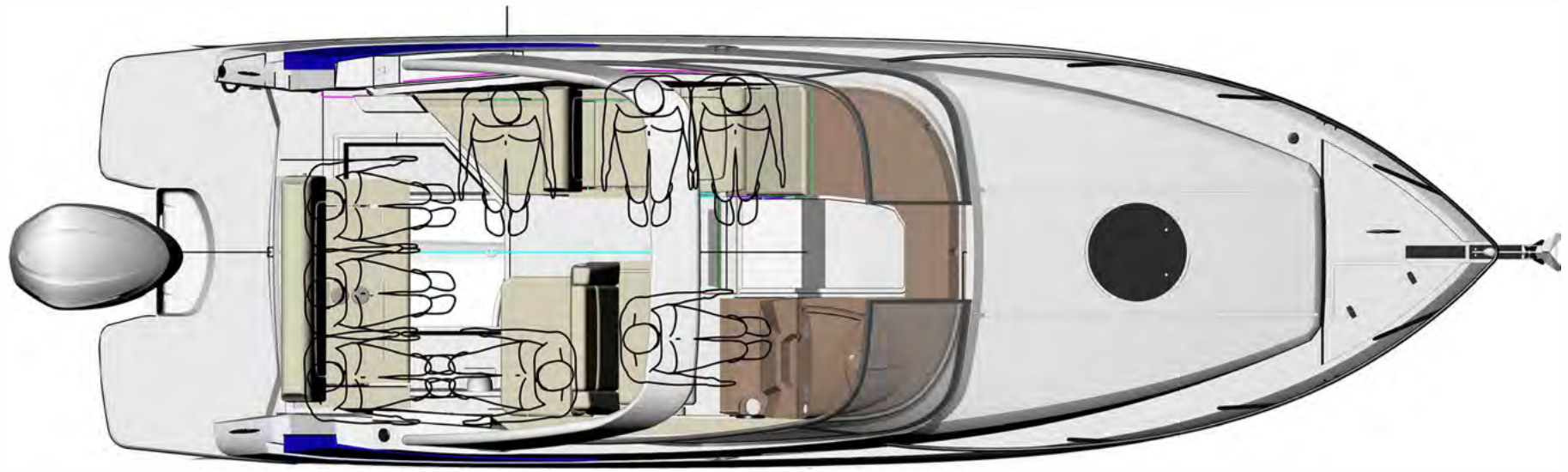
SEATING OCCUPANCY= 8 PERSONS



 REGAL MARINE INDUSTRIES 2300 JETPORT DRIVE ORLANDO, FLORIDA 32809 TEL (407) 851-4360		
ALL RIGHTS RESERVED		
DRAWING TITLE:		
26 XO (HP) Persons Capacity		
DATE:	REVISION:	PAGE:
11/20/15	0	1 OF 1
DRAWN BY:	APPROVED BY:	CHG. NO.:
JAL	DR	2

PROPRIETARY AND CONFIDENTIAL:
 THE INFORMATION CONTAINED IN THIS DRAWING IS THE SOLE PROPERTY OF REGAL MARINE INDUSTRIES. ANY REPRODUCTION IN PART OR AS WHOLE WITHOUT THE WRITTEN PERMISSION OF REGAL MARINE INDUSTRIES IS PROHIBITED.

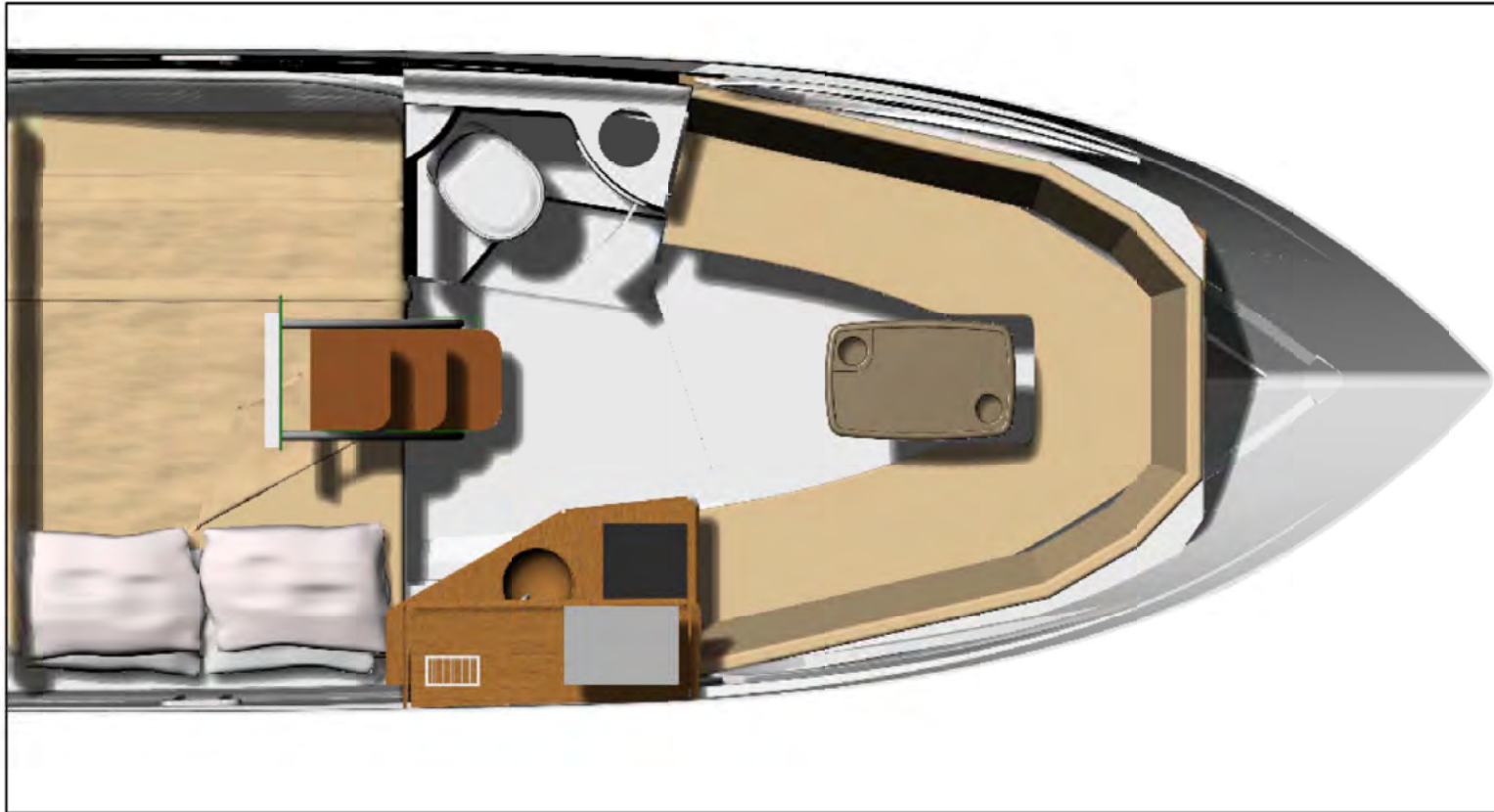

PROPRIETARY AND CONFIDENTIAL:
 THE INFORMATION CONTAINED IN THIS DRAWING IS THE SOLE PROPERTY OF REGAL MARINE INDUSTRIES. ANY REPRODUCTION IN PART OR AS WHOLE WITHOUT THE WRITTEN PERMISSION OF REGAL MARINE INDUSTRIES IS PROHIBITED.

 REGAL MARINE INDUSTRIES 2300 JETPORT DRIVE ORLANDO, FLORIDA 32809 TEL 407-851-4300		
DRAWING TITLE 26 XO (HP) General Arrangement		
DATE:	REVISION:	PAGE:
11/20/15	0	1 OF 1
DRAWN BY:	APPROVED BY:	DRG. NO.:
JAL	DR	3



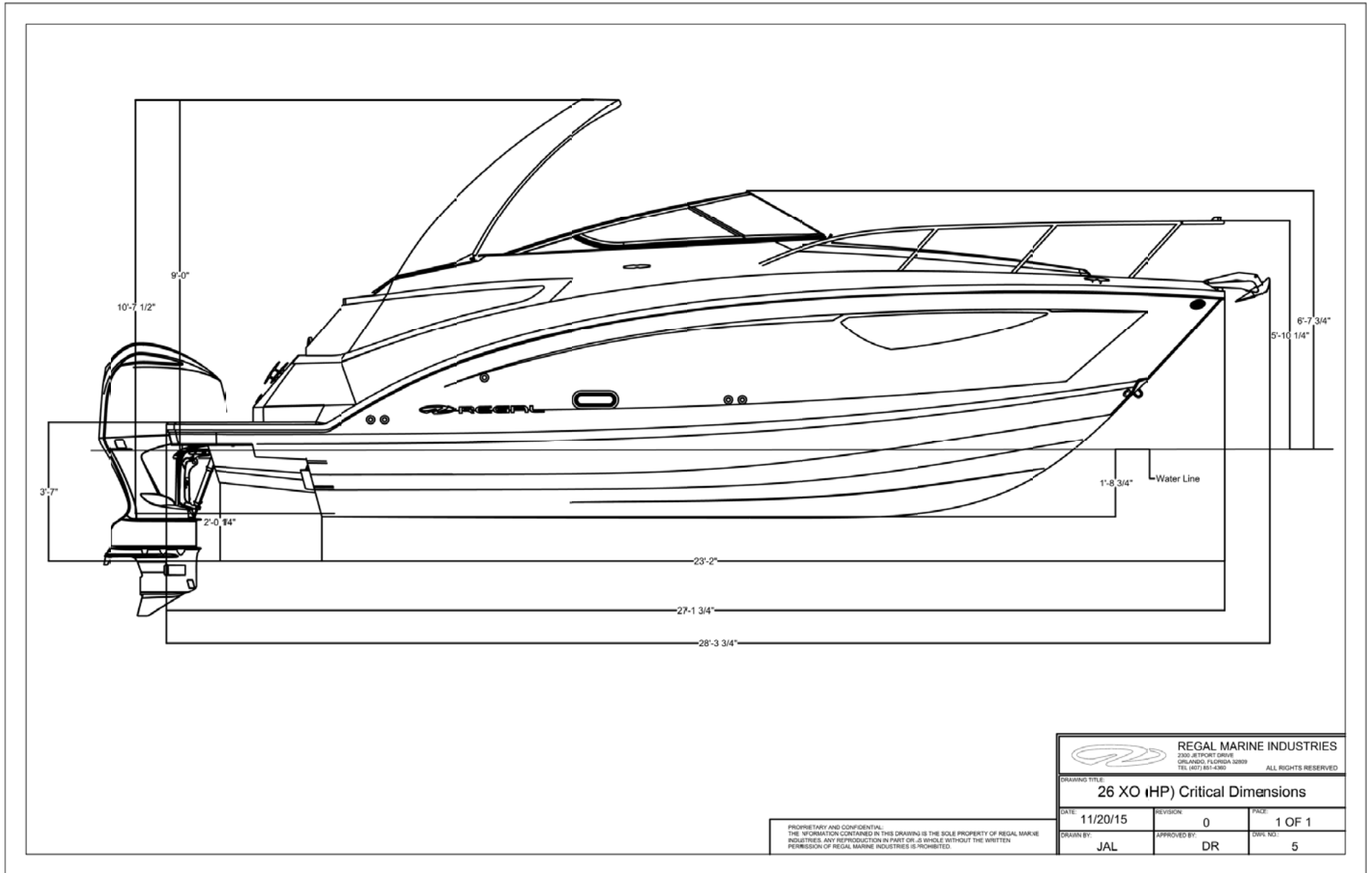

 REGAL MARINE INDUSTRIES 2302 SE TYPHOON DRIVE ORLANDO, FLORIDA 32809 TEL (407) 881-4360		
ALL RIGHTS RESERVED		
DRAWING TITLE:		
26 XO (HP) Critical Dimensions		
DATE:	REVISION:	PAGE:
11/20/15	0	1 OF 1
DRAWN BY:	APPROVED BY:	DWG. NO.:
JAL	DR	5

PROPRIETARY AND CONFIDENTIAL.
 THE INFORMATION CONTAINED IN THIS DRAWING IS THE SOLE PROPERTY OF REGAL MARINE INDUSTRIES. ANY REPRODUCTION IN PART OR IN WHOLE WITHOUT THE WRITTEN PERMISSION OF REGAL MARINE INDUSTRIES IS PROHIBITED.

STBD View

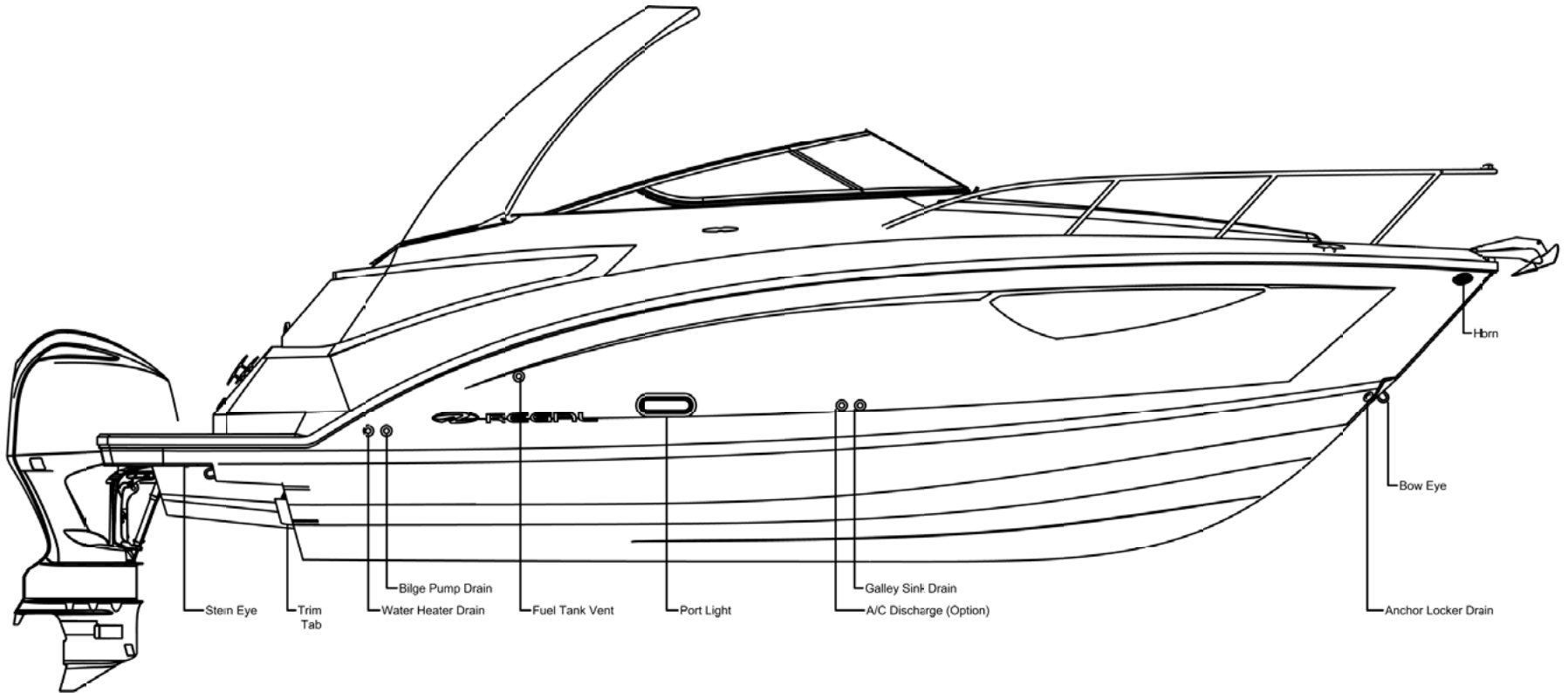

PROPRIETARY AND CONFIDENTIAL:
THE INFORMATION CONTAINED IN THIS DRAWING IS THE SOLE PROPERTY OF REGAL MARINE INDUSTRIES. ANY REPRODUCTION IN PART OR AS WHOLE WITHOUT THE WRITTEN PERMISSION OF REGAL MARINE INDUSTRIES IS PROHIBITED.

 REGAL MARINE INDUSTRIES <small>2200 JETPORT DRIVE ORLANDO, FLORIDA 32809 TEL (407) 851-4300</small>		
<small>DRAWING TITLE:</small> 26 XO (HP) Hull Hardware		
<small>DATE:</small> 11/20/15	<small>REVISION:</small> 0	<small>PAGE:</small> 1 OF 2
<small>DRAWN BY:</small> CVL	<small>APPROVED BY:</small> DR	<small>DWG. NO.:</small> 6

Port View

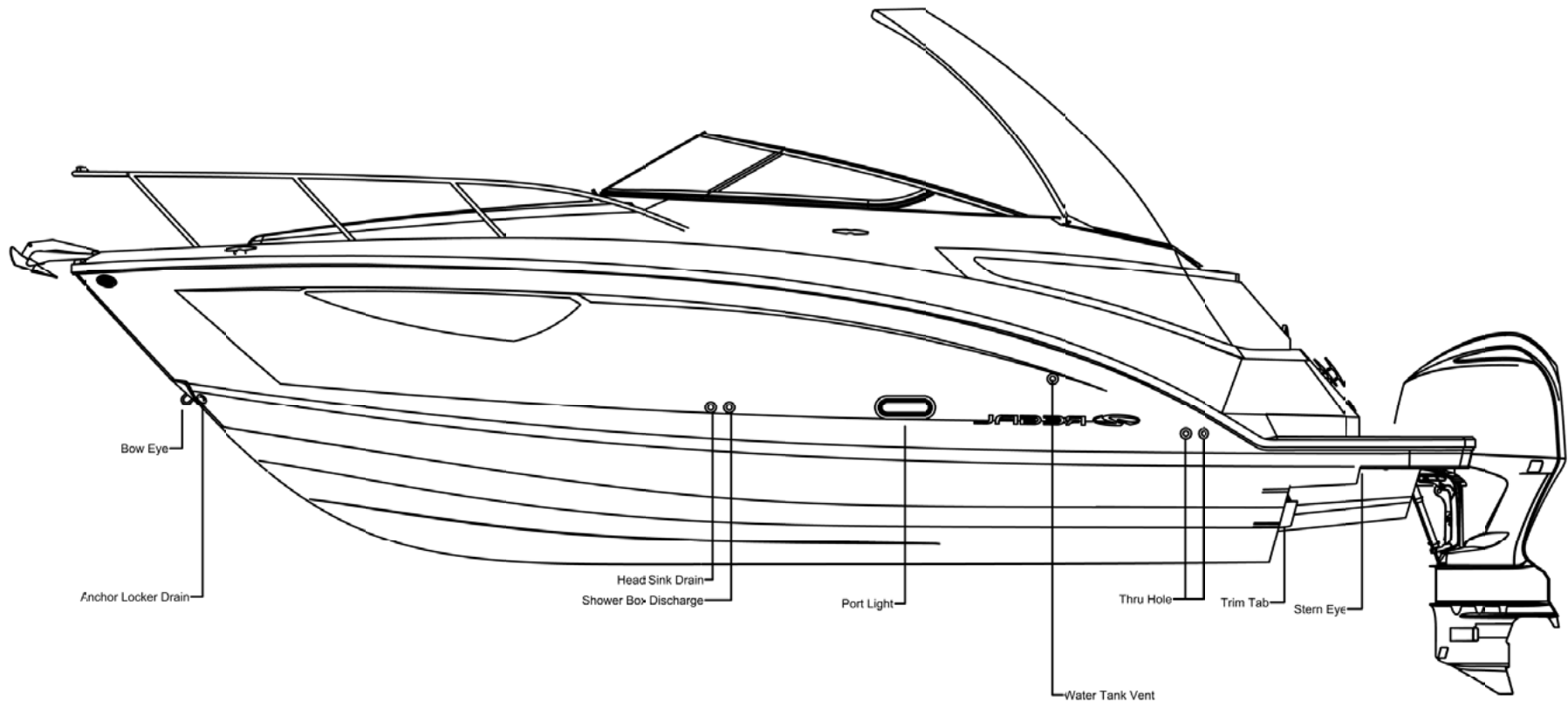

PROPRIETARY AND CONFIDENTIAL
 THE INFORMATION CONTAINED IN THIS DRAWING IS THE SOLE PROPERTY OF REGAL MARINE INDUSTRIES. ANY REPRODUCTION IN PART OR AS A WHOLE WITHOUT THE WRITTEN PERMISSION OF REGAL MARINE INDUSTRIES IS PROHIBITED.

 REGAL MARINE INDUSTRIES 3300 JETPORT DRIVE ORLANDO, FLORIDA 32835 TEL (407) 901-4300 ALL RIGHTS RESERVED		
DRAWING TITLE:		
26 XO (HP) Hull Hardware		
DATE:	REVISION:	PAGE:
11/20/15	0	2 OF 2
DRAWN BY:	APPROVED BY:	DWG. NO.:
CVL	DR	6

Deck View

- KEY
- A. FUEL TANK
 - B. FUEL TANK FILLING POINT
 - C. WATER TANK
 - D. WATER TANK FILLING POINT
 - E. HOLDING TANK
 - F. HOLDING TANK EMPTYING POINT
 - G. SEACOCKS
 - H. THRU-HULL FITTINGS
 - I. AUTOMATIC FIRE EXTINGUISHER
 - J. CARBON MONOXIDE DETECTOR
 - K. ESCAPE HATCH
 - L. ANCHOR STOWING POINT
 - M. TOWING STOWING POINT
 - N. BATTERY SWITCH
 - O. BILGE PUMP

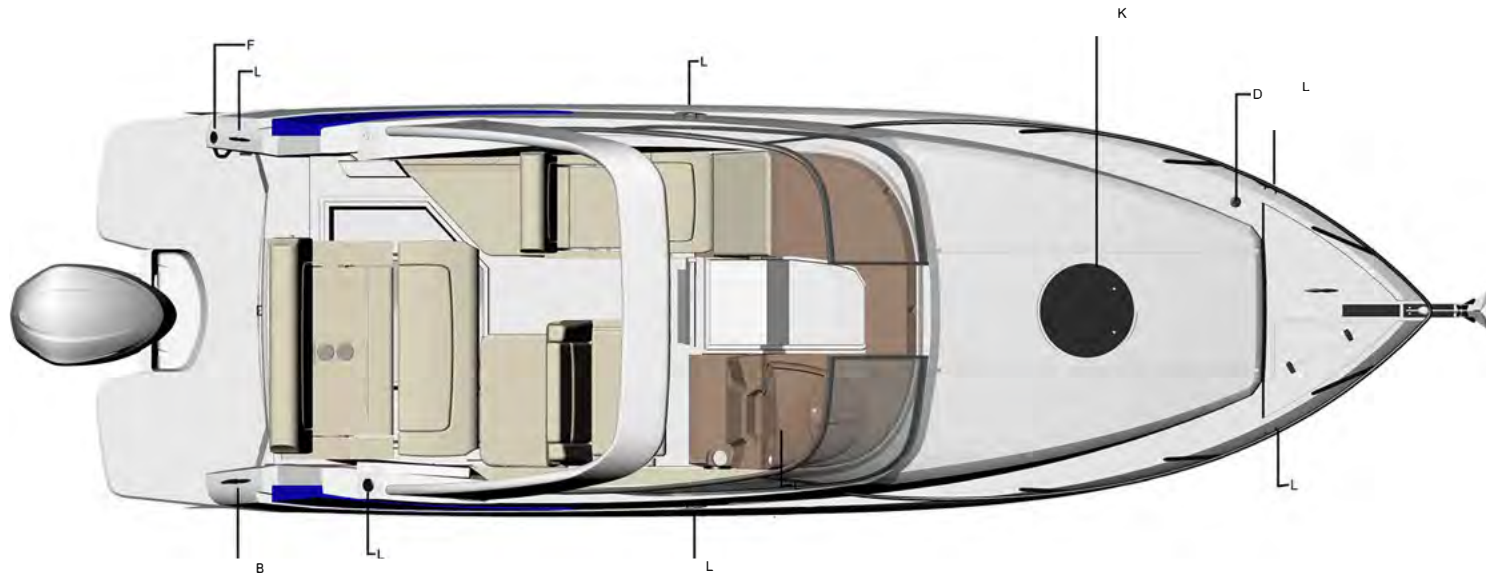

PROPRIETARY AND CONFIDENTIAL:
THE INFORMATION CONTAINED IN THIS DRAWING IS THE SOLE PROPERTY OF REGAL MARINE INDUSTRIES. ANY REPRODUCTION IN PART OR AS WHOLE WITHOUT THE WRITTEN PERMISSION OF REGAL MARINE INDUSTRIES IS PROHIBITED.



REGAL MARINE INDUSTRIES
2300 JETPORT DRIVE
ORLANDO, FLORIDA 32809
TEL (407) 851-4360 ALL RIGHTS RESERVED

DRAWING TITLE:
26 XO (HP) Component Location

DATE: 11/20/15 REVISION: 0 PAGE: 1 F 1

DRAWN BY: JAL APPROVED BY: DR DWG. NO.: 7

General Note:
Refer to the Workmanship Standard
WS004 for Hardware Sealing Requirements

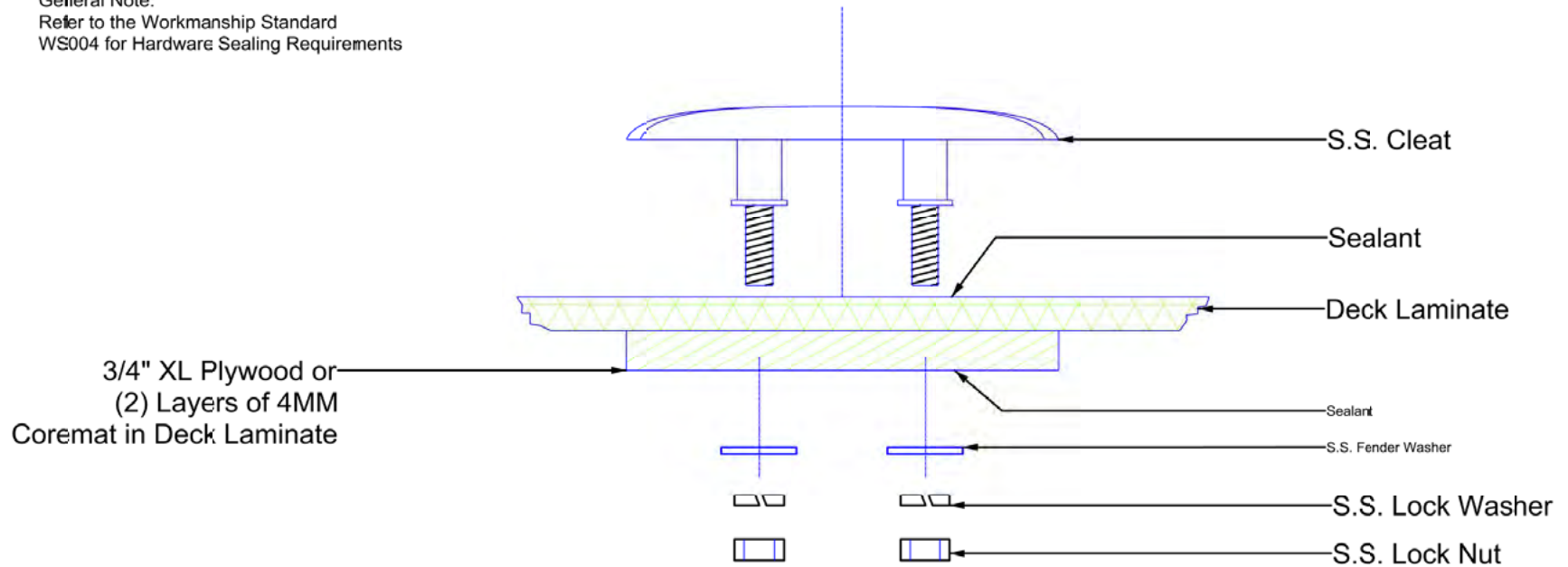

PROPRIETARY AND CONFIDENTIAL:
THE INFORMATION CONTAINED IN THIS DRAWING IS THE SOLE PROPERTY OF REGAL MARINE INDUSTRIES. ANY REPRODUCTION IN PART OR IN WHOLE WITHOUT THE WRITTEN PERMISSION OF REGAL MARINE INDUSTRIES IS PROHIBITED.

 REGAL MARINE INDUSTRIES 2300 JETPORT DRIVE ORLANDO, FLORIDA 32809 TEL: 407/601-4300 ALL RIGHTS RESERVED		
DRAWING TITLE:		
26 XO (HP) Strong Point Cleat Installation		
DATE:	REVISION:	PAGE:
11/20/15	0	1 OF 1
DRAWN BY:	APPROVED BY:	DRAWING NO.:
JAL	DR	12

Plan Deck View of Equipment Layout

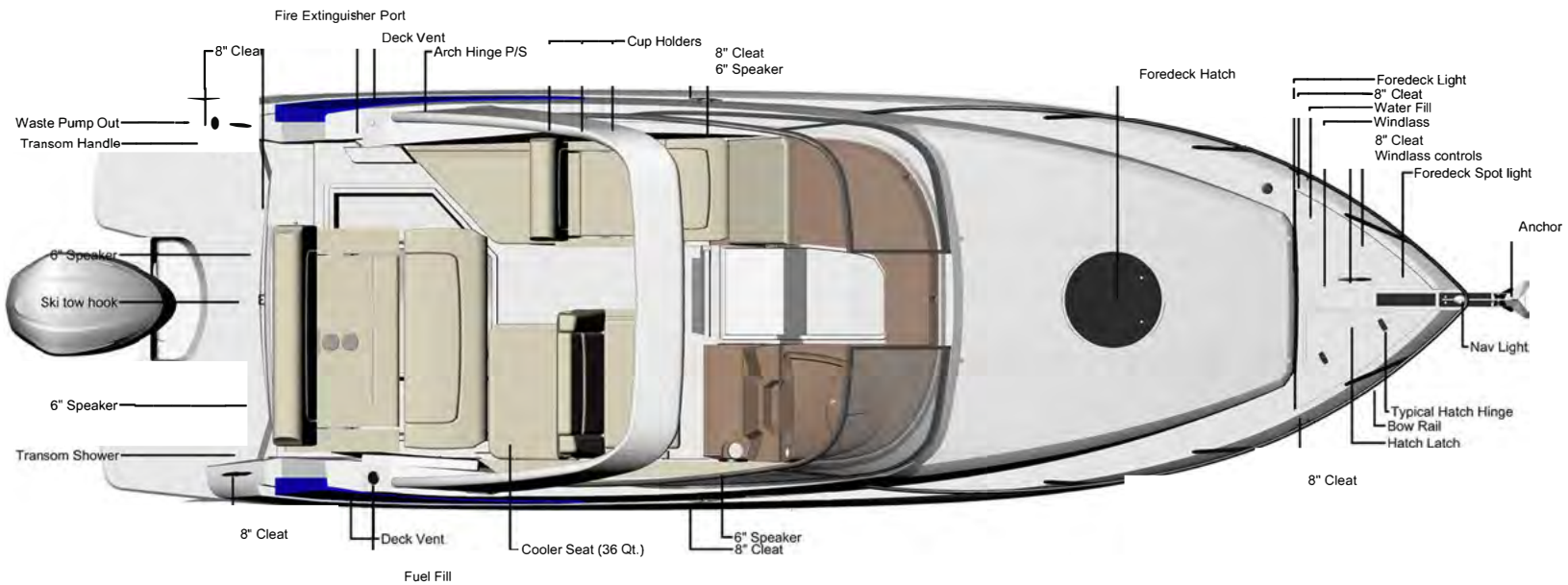



REGAL MARINE INDUSTRIES
 2300 JETPORT DRIVE
 ORLANDO, FLORIDA 32809
 TEL (407) 851-4350

DRAWING TITLE: **26 XO (HP) Deck Hardware**
 ALL RIGHTS RESERVED

DATE: 11/20/15 REVISION: 0 PAGE: OF 1
 DRAWN BY: APPROVED BY: DWG. NO: 14

PROPRIETARY AND CONFIDENTIAL
 THE INFORMATION CONTAINED IN THIS DRAWING IS THE SOLE PROPERTY OF REGAL MARINE INDUSTRIES. ANY REPRODUCTION IN PART OR AS WHOLE WITHOUT THE WRITTEN PERMISSION OF REGAL MARINE INDUSTRIES IS PROHIBITED.

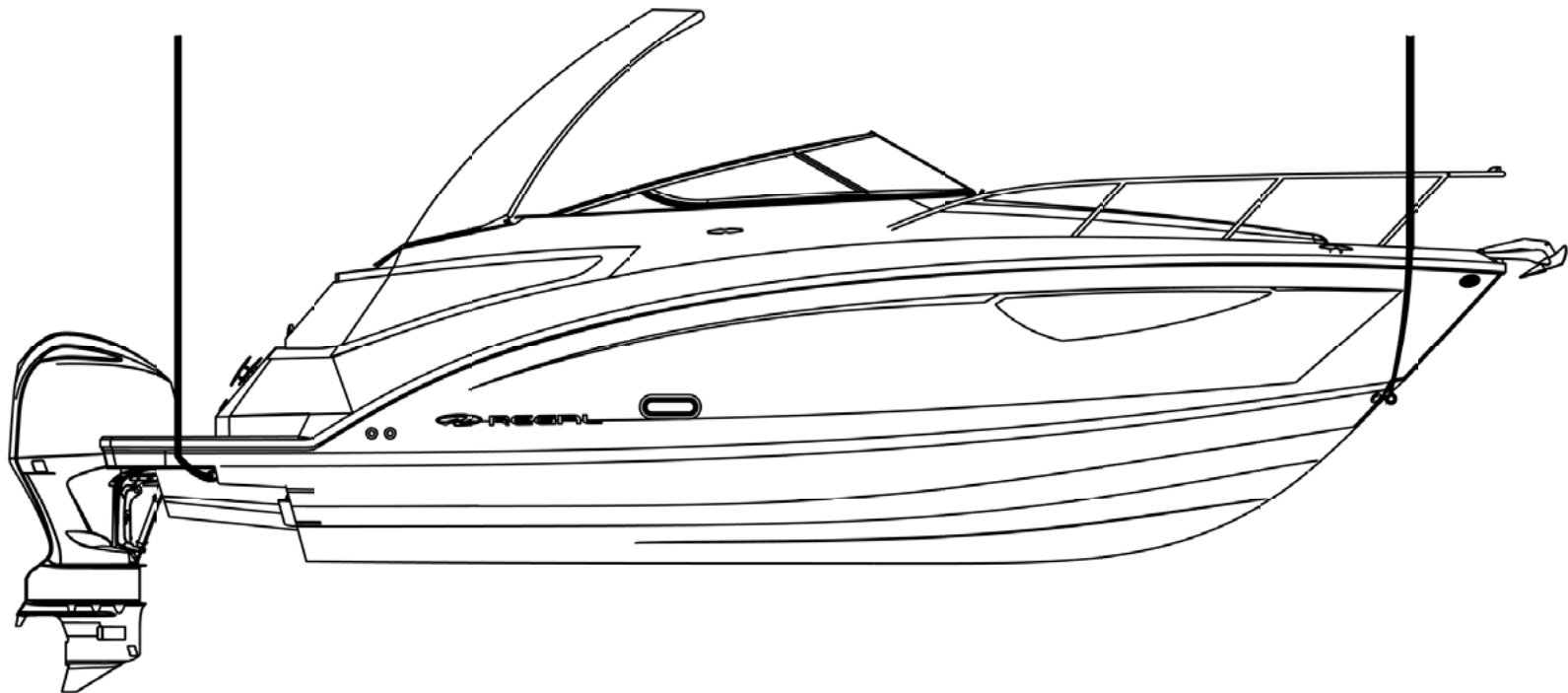
Lifting locations are at the bow and stern eyes



PROPRIETARY AND CONFIDENTIAL:
THE INFORMATION CONTAINED IN THIS DRAWING IS THE SOLE PROPERTY OF REGAL MARINE
INDUSTRIES. ANY REPRODUCTION IN PART OR AS WHOLE, WITHOUT THE WRITTEN
PERMISSION OF REGAL MARINE INDUSTRIES IS PROHIBITED.

		
REGAL MARINE INDUSTRIES 2200 JETPORT DRIVE ORLANDO, FLORIDA 32809 TEL (407) 891-4300		
ALL RIGHTS RESERVED		
DRAWING TITLE: 26 XO (HP) Sling Locations		
DATE: 11/20/15	REVISION: 0	PAGE: 1 OF 1
DRAWN BY: JAL	APPROVED BY: DR	SVG. NO.: 17

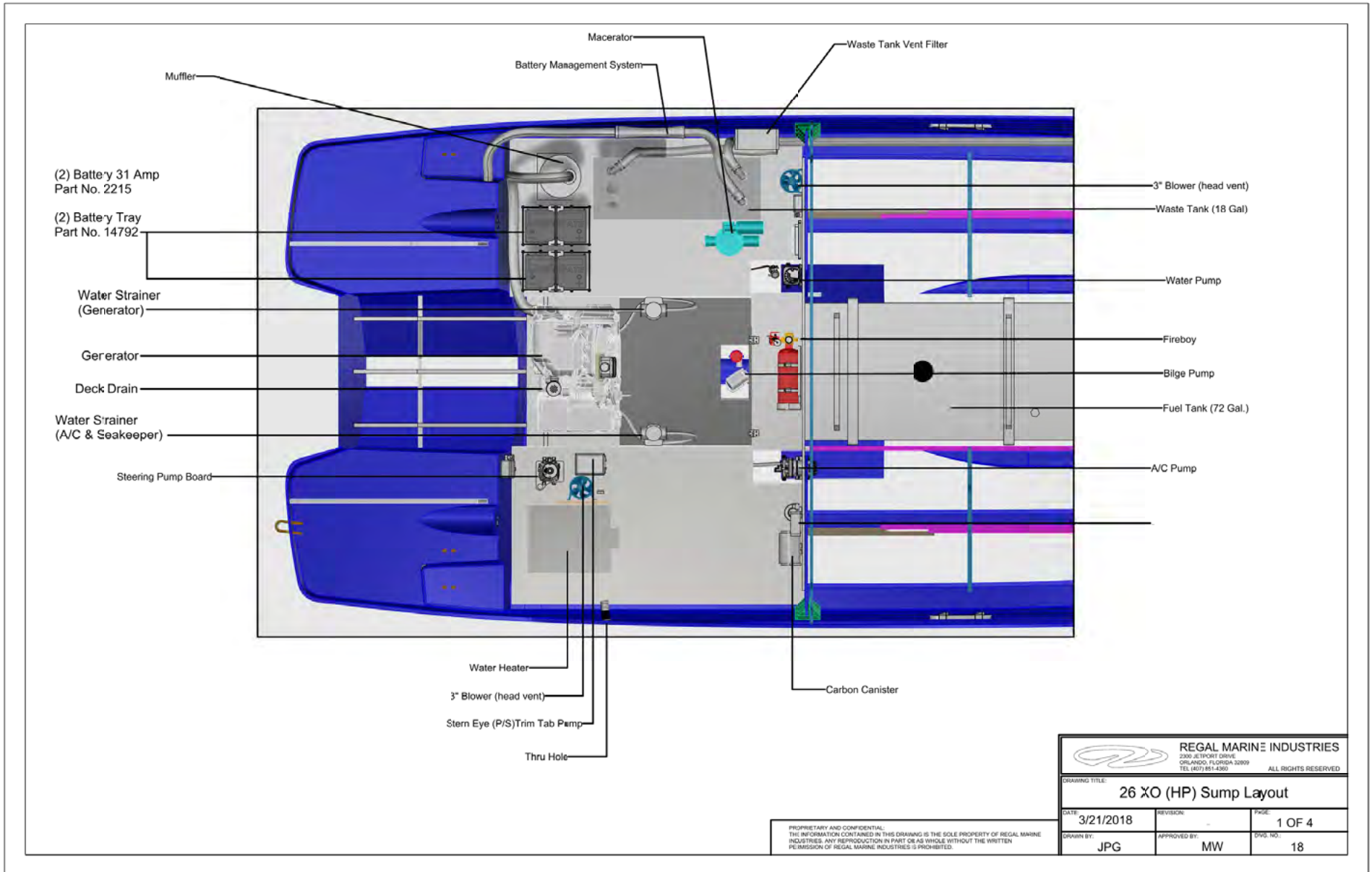

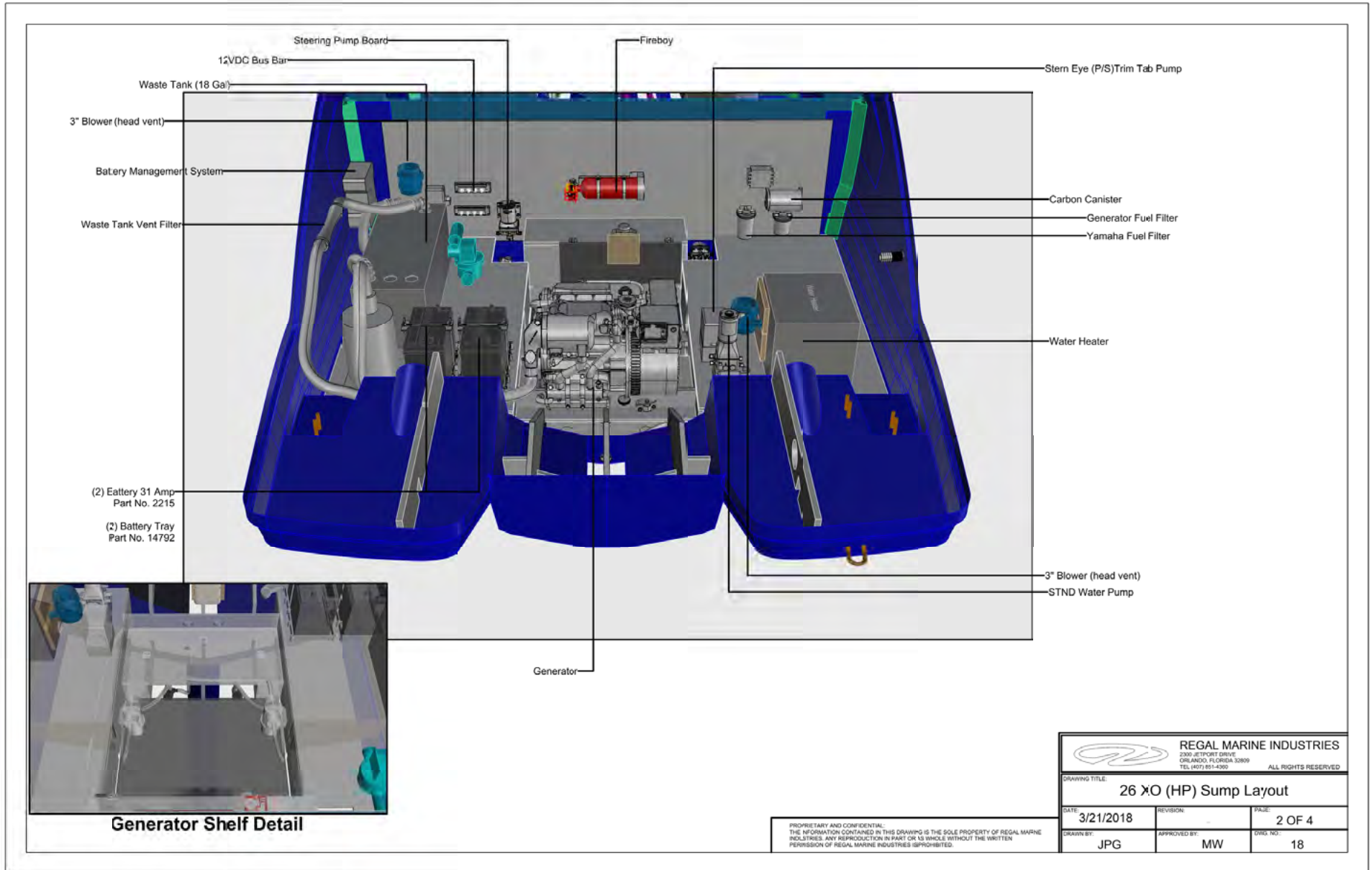

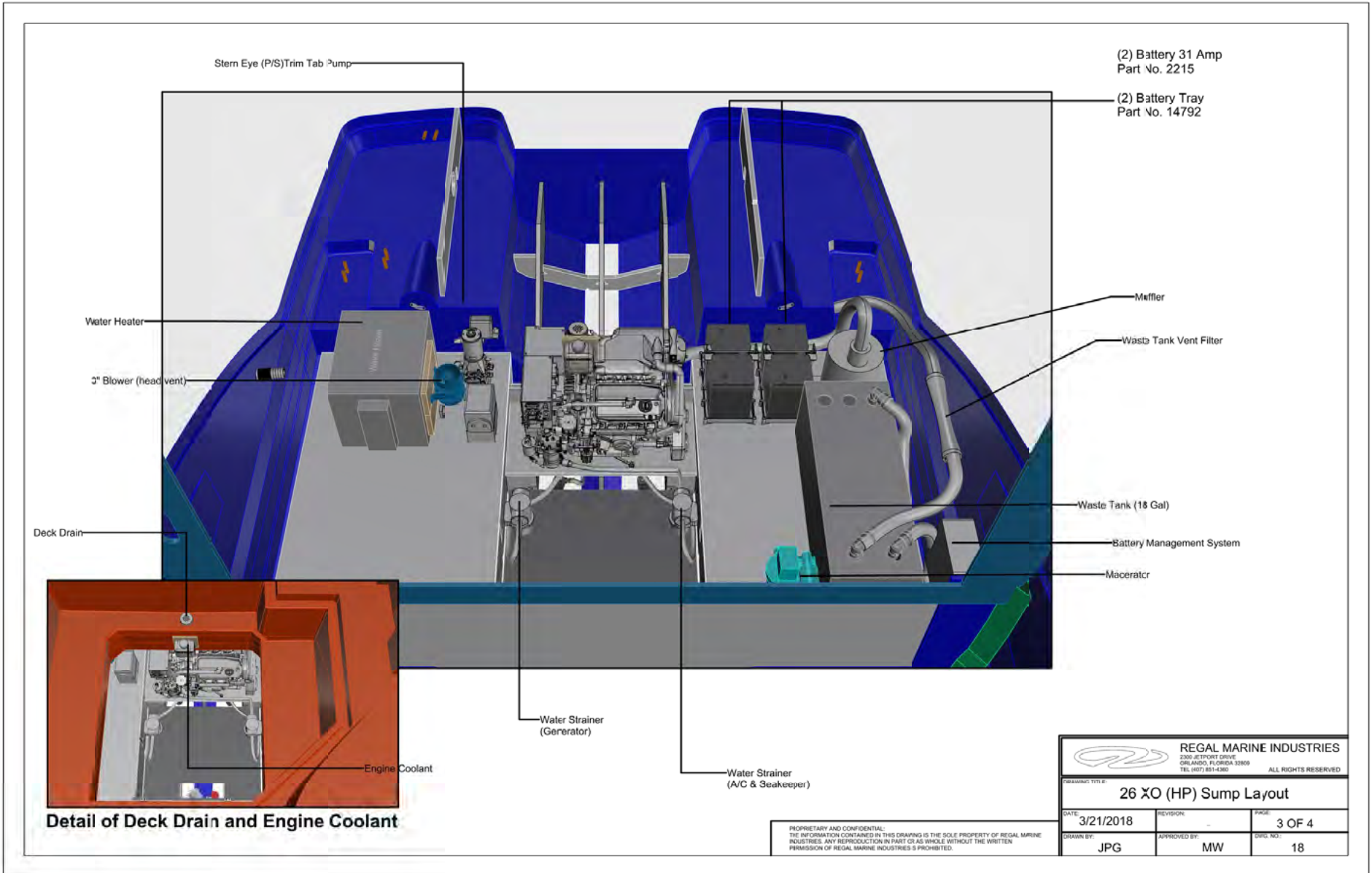

Hull Pla View of Equipment Layout

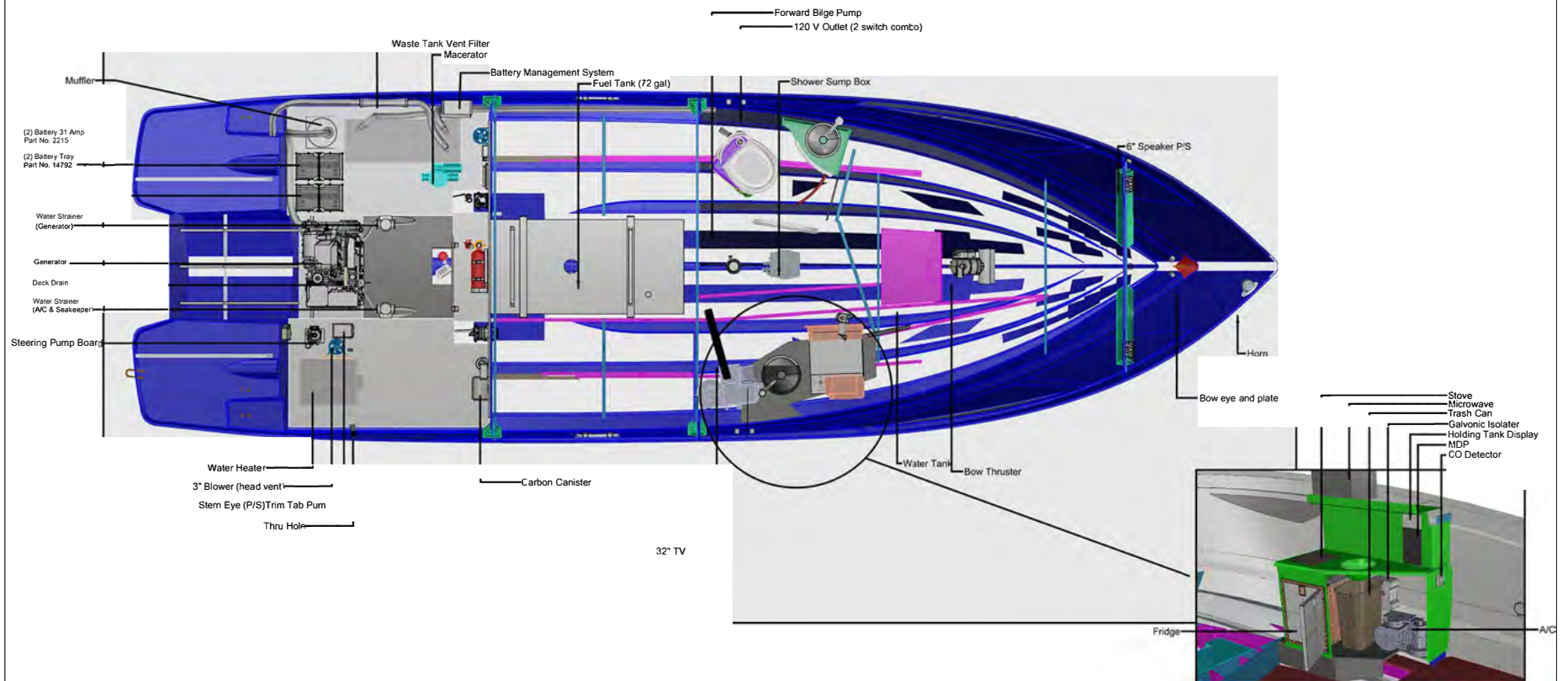



REGAL MARINE INDUSTRIES
 2300 JETPORT DRIVE
 ORLANDO, FLORIDA 32809
 TEL (407) 851-4580 ALL RIGHTS RESERVED

DRAWING TITLE: **26 XO (HP) Equipment Layout**

DATE: 3/15/2018	REVISION: 0	PAGE: 1 OF 3
DRAWN BY: JPG	APPROVED BY: MW	DWG NO.: 19

PROPRIETARY AND CONFIDENTIAL:
 THE INFORMATION CONTAINED IN THIS DRAWING IS THE SOLE PROPERTY OF REGAL MARINE
 INDUSTRIES. ANY REPRODUCTION IN PART OR AS WHOLE, WITHOUT THE WRITTEN
 PERMISSION OF REGAL MARINE INDUSTRIES IS PROHIBITED.

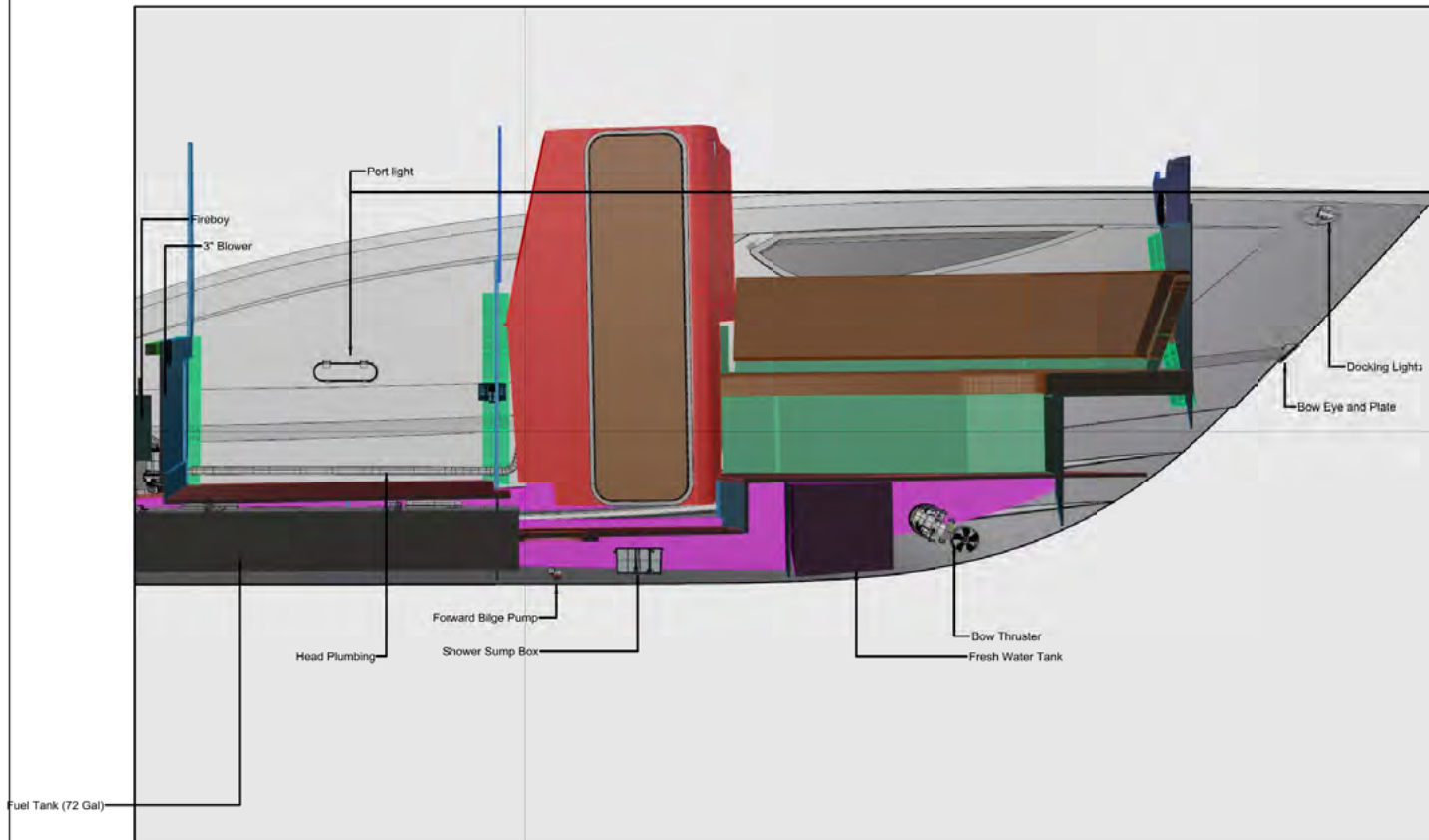
Port Hull View of Equipment Layout





Fuel Tank (72 Gal)

 REGAL MARINE INDUSTRIES <small>2300 SEPORT DRIVE ORLANDO, FLORIDA 32809 TEL: (407) 844-4300</small>		
<small>ALL RIGHTS RESERVED</small>		
DRAWING TITLE:		
26 XC (HP) Equipment Layout		
DATE:	REVISION:	PAGE:
3/15/2018	0	2 OF 3
DRAWN BY:	APPROVED BY:	DWG. NO.:
JPG	MW	19

PROPRIETARY AND CONFIDENTIAL:
THE INFORMATION CONTAINED IN THIS DRAWING IS THE SOLE PROPERTY OF REGAL MARINE INDUSTRIES. ANY REPRODUCTION IN PART OR AS WHOLE WITHOUT THE WRITTEN PERMISSION OF REGAL MARINE INDUSTRIES IS PROHIBITED.

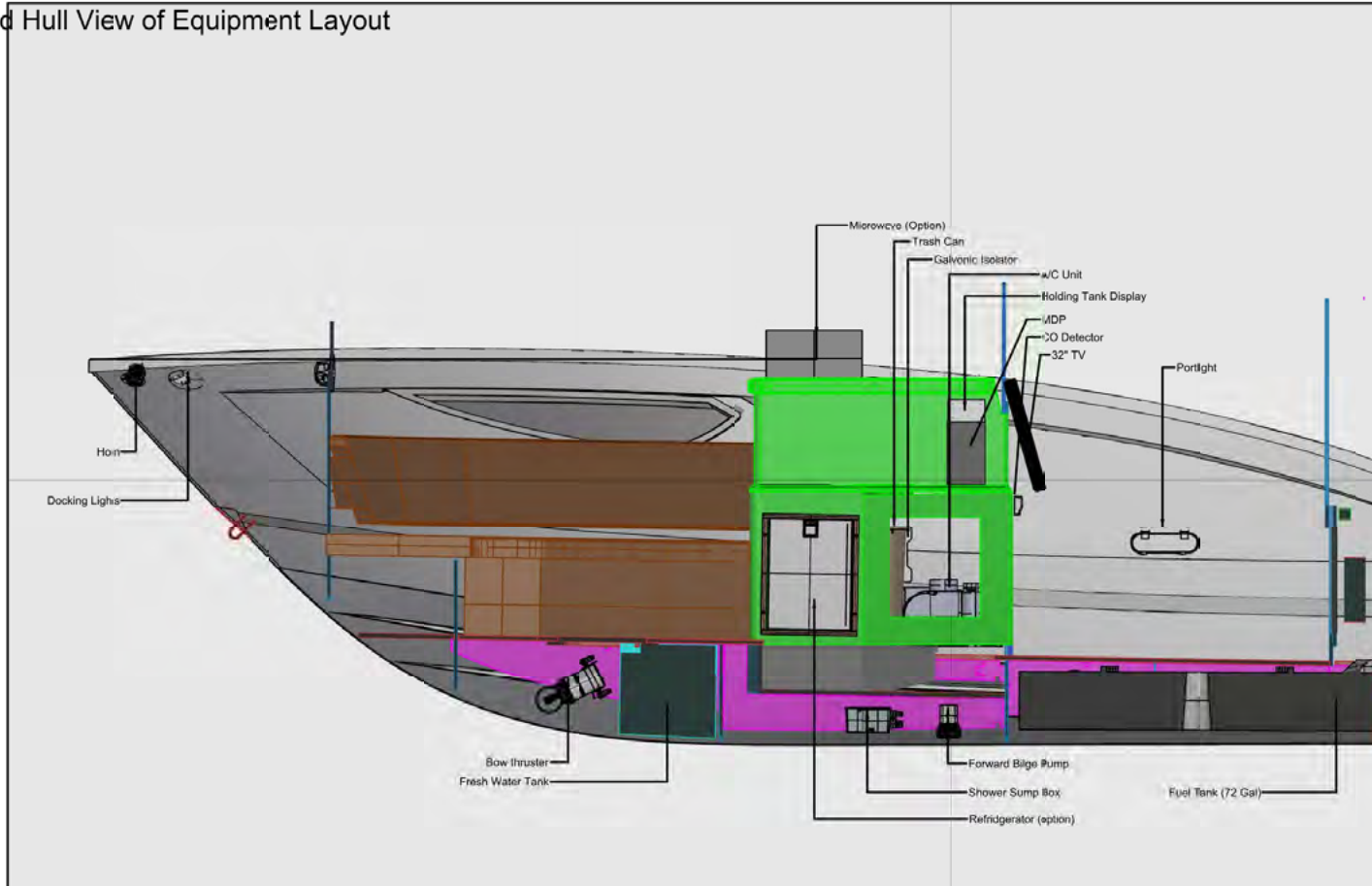
Starboard Hull View of Equipment Layout



 REGAL MARINE INDUSTRIES 2500 AIRPORT DRIVE ORLANDO, FLORIDA 32809 TEL (407) 851-4360 ALL RIGHTS RESERVED		
DRAWING TITLE:		
26 XO (HP) Equipment Layout		
DATE:	REVISION:	PAGE:
3/15/2018	0	3 OF 3
DRAWN BY:	APPROVED BY:	DWG. NO.:
JPG	MW	19

PROPRIETARY AND CONFIDENTIAL:
 THE INFORMATION CONTAINED IN THIS DRAWING IS THE SOLE PROPERTY OF REGAL MARINE INDUSTRIES. ANY REPRODUCTION IN PART OR AS WHOLE WITHOUT THE WRITTEN PERMISSION OF REGAL MARINE INDUSTRIES IS PROHIBITED.

Engine Room Section

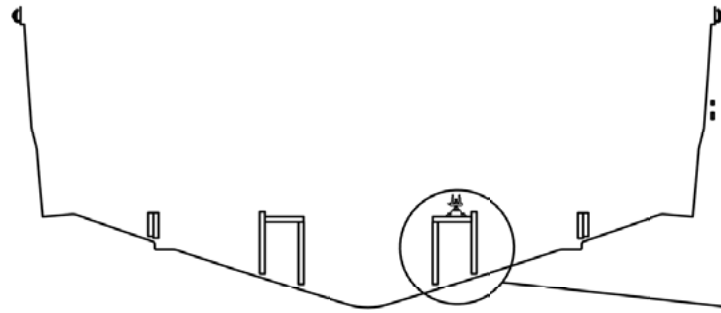

Enlarged Motor Mount

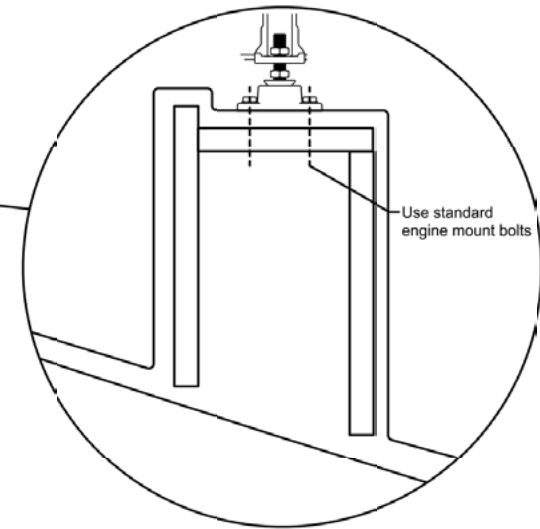

Engine Mount Lamination

Step: 1

Note: Glass around front and tab to stringer

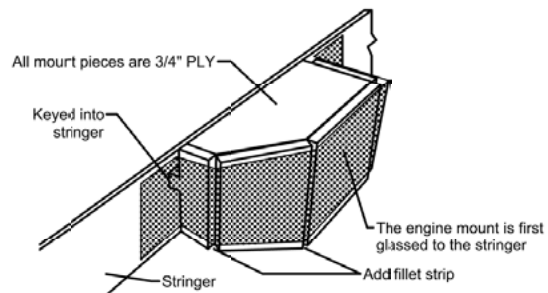

Step: 2

Note: Glass over top of stringer and tab into hull side

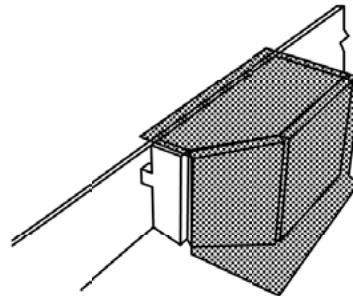

PROPRIETARY AND CONFIDENTIAL
THE INFORMATION CONTAINED IN THIS DRAWING IS THE SOLE PROPERTY OF REGAL MARINE INDUSTRIES. ANY REPRODUCTION IN PART OR AS A WHOLE WITHOUT THE WRITTEN PERMISSION OF REGAL MARINE INDUSTRIES IS PROHIBITED.

 REGAL MARINE INDUSTRIES 2300 JETPORT DRIVE ORLANDO, FLORIDA 32809 TEL (407) 851-4365 ALL RIGHTS RESERVED		
DRAWING TITLE		
26 XO (HP) Motor Mount Detail		
DATE	REVISION	PAGE
11/20/15	0	1 OF 1
DRAWN BY:	APPROVED BY:	DWG. NO.
JAL	DR	11

EXAMPLE

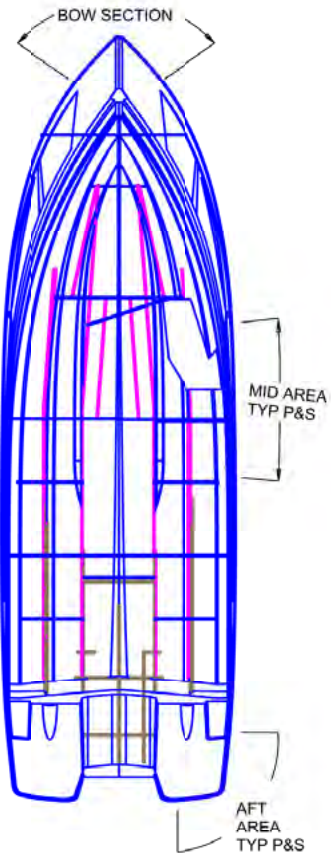

- NOTES:
1. THRU BOLT IN ENGINE COMPARTMENT, ANCHOR LOCKER AND IN ANY OTHER ACCESSIBLE LOCATIONS, OR UNLESS SPECIFIED.
 2. SCREW TOGETHER REMAINING LOCATIONS EVERY 6 TO 8 INCHES.
 3. SEAL HULL DECK SHEER AS APECIFIED ON WS047

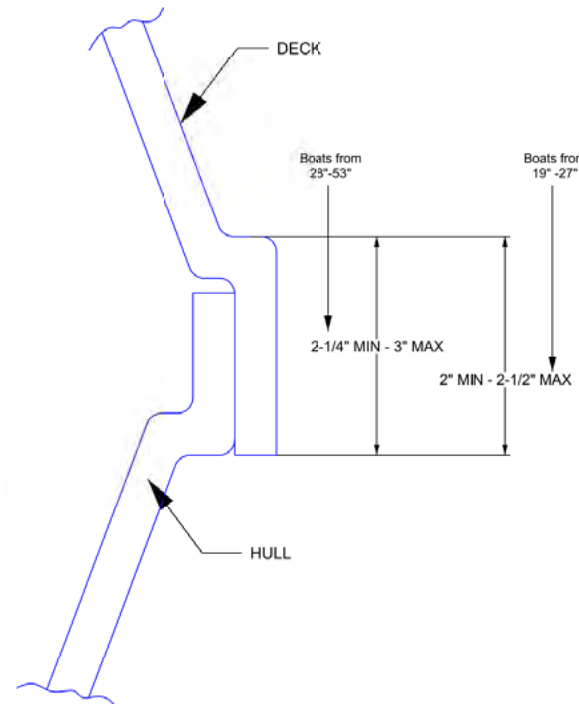
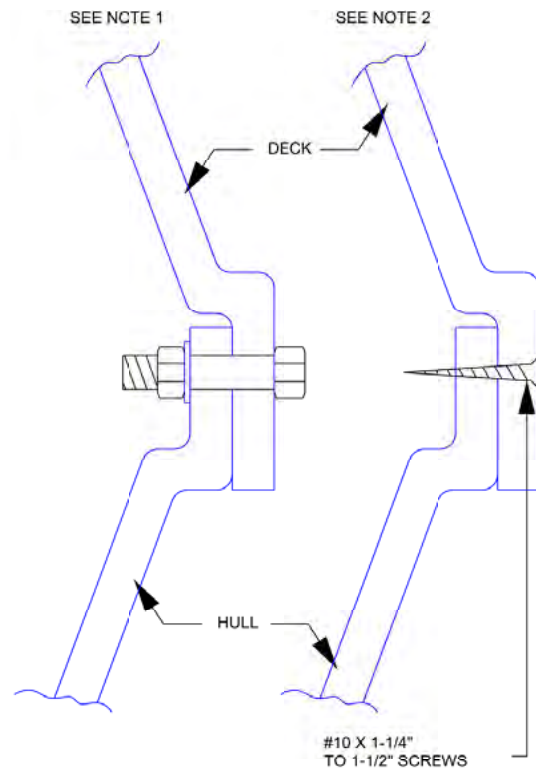

 REGAL MARINE INDUSTRIES 3305 WINDPORT DRIVE ORLANDO, FLORIDA 32809 TEL (407) 851-4300 ALL RIGHTS RESERVED		
DRAWING TITLE:		
26 XO (HP) Hull Deck Joint Detail		
DATE:	REVISION:	PAGE:
11/20/15	0	1 OF 1
DRAWN BY:	APPROVED BY:	DWG. NO.:
JAL	DR	13

PROPRIETARY AND CONFIDENTIAL:
 THE INFORMATION CONTAINED IN THIS DRAWING IS THE SOLE PROPERTY OF REGAL MARINE INDUSTRIES. ANY REPRODUCTION IN PART OR AS WHOLE WITHOUT THE WRITTEN PERMISSION OF REGAL MARINE INDUSTRIES IS PROHIBITED.