

REGAL®



OWNER'S MANUAL 42 FLY-GRANDE COUPE



Table Of Contents

1 INTRODUCTION

Regal Owner's Manual	10
Owner's Information Packet	10
General Information	11
Regal Marine Limited Warranty	18

2 SAFETY ON BOARD

Safety Labels	21
General Boating Safety	22
Required Safety Equipment	24
Fire Extinguishers	26
Visual Distress Signals	27
Sound Protecting Devices	30
Radio Communications	30
Navigation Lights	30
Marine Sanitation Devices	30
Pollution Regulations	32
Garbage Discharge	33
Life Rafts	34
U.S.C.G Minimum Equipment Requirements	34
Exhaust & Carbon Monoxide	35
Boating & Alcohol	39
Boating Accidents	40
Law Enforcement	41
Weather & Water Conditions	43



Table Of Contents

3 RULES OF THE ROAD

Navigation Rules Defined	44
Navigation Rules	46
Navigation Aids	48
Bridge Clearance	51

4 SYSTEMS

Fuel	55
Electrical	64
Generator	106
Air Conditioning	113
Fresh Water	120
Waste	129
Trim Tabs	137
Windlass	139
Entertainment	144
Volv;o Glass Cockpit	148
Electronics	150



Table Of Contents

5 ENGINE/CONTROLS

Ventilation	162
E-Key/Switches	163
Instrumentation	166
Remote Controls	171
Propulsion	175

6 VESSEL OPERATION

Getting Underway	180
Starting & Stopping	183
Fenders	184
Dock Line Basics	185
Knots	187
Docking	187
Anchoring	188
Towing/Admiralty Law	189
Emergencies	190
Environmental Awareness	193



Table Of Contents

7 AUXILIARY EQUIPMENT OPERATION

INTERIOR EQUIPMENT 195

EXTERIOR EQUIPMENT 211

8 COSMETIC CARE & MAINTENANCE

Cosmetic Care 248

Maintenance 266

9 FLY BRIDGE OVERVIEW

Features 309

10 TROUBLESHOOTING

Diagnostic Charts 315

11 STORAGE & WINTERIZATION

Checklists 330

12 GLOSSARY & INDEX 337

13 TECHNICAL

Technical Information 343

Technical Drawings 348



Table Of Contents

Note:

The information found in this owner's manual may change at any time. Designated items referred to may not be installed on your vessel. In keeping with its commitment to continued product improvement Regal Marine Industries, Inc. reserves the right to modify the vessel at any time without notice including changes in specifications, colors, fabrics, materials and equipment or to discontinue a model. Regal is not obligated to make similar changes or modifications to models sold prior to the date of such changes.

All specifications are approximate including weights, fuel figures and speeds. Speeds are calculated at sea level with a temperature of 70 to 85 degrees. Increases in altitude and/or temperature will reduce horsepower and thereby reduce the speed of the vessel.

All information is for reference only and should be used as a guideline. Consult local and state guidelines as they may differ in your area. Any decisions relating to safe operation of the vessel are the responsibility of the operator.



Introduction



Boating is becoming more popular each and every year. There are numerous types of recreational vessels on our waterways today involved in an every growing number of activities. Therefore, as a Regal yacht owner it is of the highest priority to learn about general boating practices before operating your yacht.

Your Regal yacht dealer will answer many questions and provide valuable “hands on” information during the completion of the new boat delivery process. In addition, your dealer has received special factory training on the product line and his services should be employed to solve any technical problems and periodic maintenance beyond the scope of this manual. Also, your Regal yacht dealer carries a line of factory approved parts and accessories.

Your Regal yacht dealer can provide information regarding national training organizations such as the U.S. Power Squadron and United States Coast Guard Auxiliary. Along with other organizations and literature, they can help build your “boating savvy” by developing the necessary skills and awareness to be a safe and confident skipper.

Also, your local library can assist in providing recommended boating literature such as Chapman Piloting Seamanship & Boat Handling by Elbert S. Maloney.

Also, boating information is available on the internet. Remember, waterway conditions can change in a heartbeat. Knowing how to react quickly comes from experience and knowledge which can be gained through boating education. Welcome aboard!



Chapter 1

WELCOME TO REGAL

I know I speak for everyone at Regal when I welcome you to the ever-growing family of Regal yacht owners. You've chosen a yacht that is recognized worldwide for its standard of excellence. Each step in construction has been carefully scrutinized to assure safety, performance, reliability and comfort for both your passengers and yourself.

Your yacht is certified by the National Marine Manufacturers Association. It also complies with the applicable standards set by the United States Coast Guard, American Boat and Yacht Council and the International Marine Certification Institute. Your Regal yacht was built with the same attention to detail and quality of construction that we would expect in a yacht we would purchase ourselves.

Whether you're a veteran boater or a newcomer, we strongly urge you to read this yacht owner's manual thoroughly. Familiarize yourself with the various components of your yacht, and heed the safety precautions noted herein.

If you have questions that are not covered in this manual, please consult your authorized Regal yacht dealer for assistance, phone the Regal factory at 407-851-4360 or E-mail us at www.regalboats.com.

Thank you, and welcome to the "World of Regal!"

*Duane Kuck
President & CEO*



REGAL MARINE INDUSTRIES, INC.
MISSION STATEMENT

With God's help
and a steadfast commitment to integrity,
we will develop a team
of exceptional people and relationships
to provide exceptional customer satisfaction.



Chapter 1

REGAL OWNER'S MANUAL

Your Regal yacht owner's manual has been compiled with information covering both 42 Grande Coupe and Fly models to assist you in operating your craft with safety and pleasure. This manual targets specific details of Regal related systems and components along with their location, operation and maintenance that normally is not found in the vendor information. In addition, vendor related equipment information is located within the yacht documentation package.

The Regal yacht owner's manual is not to be thought of as a complete shop technical document. In addition to the system chapters, there is troubleshooting information devoted to select current standard and optional equipment.

Beyond the owner's manual your Regal yacht dealer has received special factory training and his services should be employed to solve more technical problems.

Call 407-851-4360 or go to the internet at www.RegalBoats.com to find the closest Regal yacht dealership. In keeping with its commitment to improvement Regal Marine Industries, Inc. is continually upgrading the product line.

Regal notes that all dimensions, specifications, models, standard and optional equipment is subject to change without notice at any time.

Note that the current owner's manual is duplicated on a SD card (PDF format) which can be opened with the standard onboard Garmin plotter. Follow the directions on the SD card case for launching the owner's manual using the Garmin plotter or refer to the "glass cockpit" found later in this manual.

If desired the SD card can be downloaded on a desktop or lap top computer and printed as a PDF.

OWNER'S PACKET

An owner's information packet is located on the vessel. Read and become familiar with the materials. This packet contains valuable literature on your propulsion package, standard and optional equipment, systems, various care and cleaning instructions along with component warranty information.

Normally the owner's packet is located in one of the cabin drawers. Keep the information packet in a clean, dry location for prompt access as needed.



Introduction

GENERAL INFORMATION

HULL IDENTIFICATION NUMBER (HIN)

The United States Coast Guard has established a universal system of numerically recognizing vessels by using a hull identification number or "HIN." This number identifies your Regal yacht's model, hull number, month and year of manufacture. The HIN is normally found on your yacht's transom, on the starboard side, just below the rub rail on the transom vertical surface. The HIN is stamped on a plate and reinforced with a special adhesive. The HIN consists of 12 alpha or numeric characters.

It is recommended that you locate and write down the HIN for future reference. It can be especially useful when ordering parts from your Regal yacht dealer. A second HIN number is found in a hidden location. This second HIN is useful to authorities if the vessel is stolen and/or the original transom HIN is modified or eliminated.

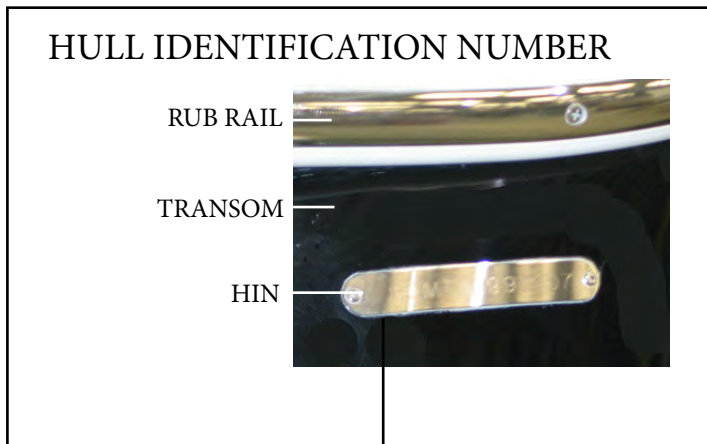

VESSEL INFORMATION SHEET

It is recommended that you fill out the information on the following page. It will supply vital statistics on your vessel. Make a copy of the data for safe keeping at home.

VESSEL FLOAT PLAN

Formulate a float plan on the following page before departing. Leave it with a responsible person who will notify the United States Coast Guard or local law enforcement authorities if you do not return as planned. If you change your plans be sure to notify this person. Make copies of the float plan and use one each time you go boating. This will help people know where to find you should you not return on schedule. Do not file the float plan with the United States Coast Guard.

NMMA YACHT CERTIFICATION PLATE

At the helm (dash) area you will notice a metal plate which recognizes that your yacht was built to design compliance in effect on the date the certification was verified. The plate also states that your vessel complies with U. S. Coast Guard safety system standards in effect on the date of certification.

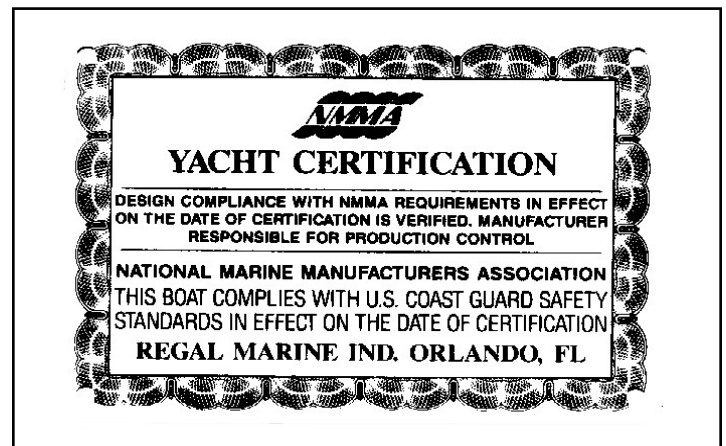



YACHT INFORMATION

Owner: _____

Address: _____

City & State: _____

Home Phone: _____ Business Phone: _____

In Case Of Emergency Notify: _____

Address _____

City _____ State _____

Phone _____

Insurance Agent's Name: _____

Policy#: _____

USCG Phone: _____ Local Police: _____

Marina Phone: _____ Slip (Dock#): _____

Hull Serial #: RGM _____

Key #: _____ Port Engine: _____ Stbd Engine: _____

Key #: _____ Cabin Door: _____

Selling Dealer: _____

Address: _____

City & State: _____

Phone: _____ Fax: _____

Servicing Dealer: _____

Address: _____

City & State: _____

Phone: _____ Fax: _____



Introduction

YACHT FLOAT PLAN

Fill out this form before departure. Leave it with a responsible person who will notify the Coast Guard or police if you don't return as planned. If you change your plans be sure to notify this person. Make copies of the float plan and use one each time you go on a trip. This will help people know where to find you should you not return on schedule. Do not file this plan with the Coast Guard.

Owner: _____

Address: _____

City & State: _____

Telephone#: _____

Person Filing Report: _____

Name _____

Telephone _____

Make Of Yacht: _____

Length _____ Boat Name _____

Color _____ Trim _____ Hp _____

Inboard _____ Stern Drive _____

Hull I.D.# _____

Documented Vessel # _____

Other Information _____

Safety Equipment Aboard: _____

Life Jackets

First Aid Kit

Flares

Flash Light

VHF Radio

Cell Phone ___#_____

Computer ___Desk Top ___Lap Top___

E-mail address _____

Food _____ Water _____

State Registration# _____

Destination:

Leave From _____

Time Left _____

Going To _____

Fuel Capacity _____

Est. Day Of Arrival _____

Est. Time Of Arrival _____

If Not Back By _____ o'clock Call Authorities

Persons Aboard:

Name

Age

Address

Phone

____ See Other Side For Additional Persons



YACHT CRUISE CHECKLIST

- Obtain a current weather update.
- Periodically hoist the yacht & inspect the hull bottom and propellers for damage. Marine growth such as barnacles will affect performance and fuel efficiency. Check sacrificial anodes located on the IPS propulsion unit, transom and engine. Replace anode if less than 2/3 remaining.
- Check the electrical system and all safety related equipment. Carry extra fuses. Ensure they are of the proper capacity and type.
- If your yacht has been in the water, run the bilge pump until the flow of water stops.
- If your yacht has been out of the water, check to see that all bilge water has drained.
- Check that all required safety equipment is on board and in good working condition. Examples include personal flotation devices (PFD's), horn, bell, hand held fire extinguishers, and visual distress signals.
- Check fuel level. Fuel tanks should be filled to slightly less than capacity. Allow for fuel expansion. Remember the "one third rule".
- Open engine compartment. Inspect for fuel odors and visible leaks in the fuel, oil, coolant, exhaust and power steering systems.
- Check the diesel fuel filters for the presence of water .
- Check fluid levels of engines, drives and generator.
- Visually inspect engine for cracked hoses, worn or loose V-belt, and loose hardware.



RECOMMENDED ON BOARD EQUIPMENT

TOOLS

Allen Wrenches
Jack Knife
Phillips Screwdriver
System
Regular & Needle Nose Pliers
Combination Box & End Wrench Set
Screwdriver Set (One With Various Tips)
Side Cutters
Ratchet & Socket Set
Electrical Crimper, Cutter, Stripper Combo
Hammer
VOA Electrical Tester
Water Pump Pliers
Vise Grip Pliers
Floating Flashlight/Lantern
Oil/Fuel Filter Wrench
Tape Rule

SPARE PARTS

Fuel Filters-Engines & Generator
Poly V- Belt (See Engine Manual)
Coolant For Engine Freshwater
Extra Light Bulbs -non-LED type
Seawater Filter
Fuses
Propeller Set (See Dealer)
Propeller Hardware
Flashlight Batteries
Engine Spare Parts
Generator Spare Parts
Air Filters-Engine & Generator
Oil Filters-Engine, Generator
Drive Oil Filters

BASIC GEAR & SUPPLIES

Tow Line
Mooring Lines
Dock Fenders
Distress Signals
First Aid Kit
Boat Hook
Charts & Plotting Instruments/Back-up Use
Emergency Food & Water
Funnel
Bailer or Hand Pump
Extra Hand Held Fire Extinguishers
Personal Floatation Devices
Clean Rags, Diapers (For Under Engine-Oil Leaks)
Sunscreen (SPF 30+)
Bucket/Pans w/Lids-Draining/Storing Used Fluids
Mirror (For Inspection & Emergency Signaling)

BASIC GEAR & SUPPLIES

Lubricating Oil, Liquid Wrench
Duct & Electricians Tape
Coolant (Engine Freshwater Side)
Engine, Drive, Power Steering Oil
Boat Soap (Not Dish Soap)
Woody Wax
Vinyl Cleaner
Hydrogen Peroxide (AC Pans)
Life Raft
Rust Stain Remover (Starbrite)
Corrosion Block
Bilge Cleaner
Nylon Windbreaker Suit
Shop Vac (1 Gal. Cap. Wet-Dry)
Squeegee
Binoculars



Owner's Registration & Systems Checklist

Please note that your Regal yacht requires the proper registration by your authorized Regal yacht dealer. To initiate the vessel warranty your dealer must complete the owner's registration form and systems checklist at the time of delivery. The owner must sign the paperwork to acknowledge that the dealer has reviewed the boat systems and warranty provisions with the owner. The owner should keep the original paperwork that features a temporary warranty registration. A warranty certificate will be sent approximately 6 weeks after receipt of the paperwork at Regal World Headquarters.

Dealer's Responsibility

Your vessel has undergone rigid quality assurance inspections before leaving the factory. In addition, your dealer has been trained to perform final pre-delivery checks and to service your Regal yacht.

Your dealer's responsibilities include:

1. An orientation in the operation of your Regal yacht including matters relating to the safe operation of the vessel.
2. Completion and mailing of your boat registration warranty form to Regal.
3. Location of vendor warranties, registration materials, owner's manual, operation, installation and maintenance instructions for auxiliary equipment supplied with or installed on your Regal boat.



Introduction

Owner's Responsibility

You are entitled to all the benefits and services outlined in your Regal warranty. However, you have certain responsibilities to ensure warranty satisfaction.

These are:

To read the warranty materials and understand them fully.

To examine the yacht in detail at the time of delivery.

Apply the following: boating rules and regulations, safety equipment, environmental regulations, accident reports and warranty regulations terms and conditions.

To read thoroughly all literature supplied with your yacht including this owner's manual and to follow the recommendations in the literature.

To provide proper maintenance and periodic servicing of your yacht and equipment as set forth in the various manuals supplied.

Customer Service

Take the time to write down your yacht dealer's phone number and E-mail address for future reference. Along with your Regal yacht dealer information is a listing below of other phone numbers and web addresses which may prove useful.

Regal Yacht Dealer:

Phone: _____

E-mail: _____

Regal Marine Customer Service:

1-800-US REGAL (1-800-877-3425)

regal@regalboats.com

customer.service@regalboats.com

Volvo Penta Of America (24-Hour Hotline Support):

1-800-522-1959

vpa.consumerrelations@volvo.com



Chapter 1

REGAL MARINE INDUSTRIES, INC. LIMITED WARRANTY

Welcome to the Worldwide Family of Regal Owners! We are very pleased that you have chosen a Regal Powerboat!

This document is your Warranty Registration Certificate and Statement of Warranty. Please check the registration information section for accuracy. If this information is not correct or if you change your address at some future date, please notify us at the following address: Regal Marine Industries, Inc. Attention: Warranty Registrations, 2300 Jetport Drive, Orlando, Florida 32809; or E-mail at customer.service@regalboats.com.

Please read the warranty carefully. It contains important information on Regal's claims procedures and your rights and obligations under this warranty.

WHAT IS COVERED: This Limited Warranty applies only to Regal boats beginning with model year 2013.

LIFETIME LIMITED STRUCTURAL HULL WARRANTY: Regal Marine Industries, Inc. warrants to the original retail purchaser of this boat if purchased from an authorized Regal dealer that the selling dealer or Regal will repair or replace the fiberglass hull if it is found to be structurally defective in material or workmanship for as long as the original retail purchaser owns the boat. For purposes of this warranty, the hull is defined as the single fiberglass casting which rests on the water. This limited warranty is subject to all limitations and conditions explained below.

FIVE-YEAR TRANSFERABLE LIMITED STRUCTURAL HULL WARRANTY: In addition to the Lifetime Limited Structural Hull Warranty, Regal offers a Transferable Five-Year Limited Structural Hull Warranty. Under the Five-Year Transferable Limited Structural Hull Warranty, Regal will repair or replace the fiberglass hull if it is found to be structurally defective in material or workmanship within the first (5) years after the date of delivery to the original retail purchaser. Any remaining term of this Five-Year Limited Hull Warranty may be transferred to a second owner if within 60 days of purchase, the new owner registers the transfer with Regal and pays the established warranty transfer fee. Contact Regal Customer Service at the above address for details.

FIVE-YEAR LIMITED HULL BLISTER WARRANTY: Regal warrants that the selling dealer or Regal will repair any underwater gelcoated surfaces of the hull against laminate blisters which occur as a result of defects in material or workmanship within (5) years of the date of delivery, provided that the original factory gelcoat surface has not been altered. Alternation would include but is not limited to damage repair; excessive sanding, scraping, sandblasting; or from improper surface preparation for application of a marine barrier coating or bottom paint, any of which shall void this Five-Year Limited Hull Blister Warranty. Proper preparation must be applied to the hull bottom if the boat is to be moored in the water for periods in excess of sixty (60) days. Regal Marine shall repair or cause to be repaired any covered laminate blisters based on the following prorated schedule.

Less than two (2) years from delivery date - 100%, Two (2) to three (3) years from delivery date - 75%, Three (3) to four (4) years from delivery date - 50%, Four (4) to five (5) years from delivery date - 25%.

Reimbursement shall be limited to one repair, not to exceed one hundred (\$100.00) dollars per foot of boat length prior to prorating. Regals prior authorization for the method and cost of repair, must be obtained before repairs are commenced. All costs to transport the boat for repairs are the responsibility of the owner.

LIMITED GENERAL WARRANTY: In addition to above hull warranties, Regal warrants to the original purchaser of this boat if purchased from an authorized Regal dealer that the dealer or Regal will repair or replace any parts found to be defective in materials or workmanship for a period of one (1) year from the date of delivery, subject to all exceptions, limitations and conditions contained herein.

LIMITED EXTERIOR FINISH WARRANTY: Regal warrants that the selling dealer or Regal will repair cosmetic defects in the exterior gelcoated finish including cracks or crazing reported to Regal within 90 days from the date of delivery to the original retail purchaser, subject to all limitations and conditions contained herein. All warranty work is to be performed at a Regal dealership or other location authorized by a Regal Customer Service Manager after it is established to Regal's satisfaction that there is a defect in material or workmanship.

REGISTRATION INFORMATION:

CUSTOMER OBLIGATIONS: The following are conditions precedent to the availability of any benefits under these limited warranties:

- (a) The purchaser must sign and the dealer must submit to Regal the "NEW BOAT DELIVERY CHECKLIST" within ten (10) days of the date of delivery and such information must be on file at Regal.
- (b) The purchaser must first notify the dealer from whom the boat was purchased of any claim under this warranty within the applicable warranty period and within a reasonable period of time (not to exceed thirty (30) days) after the defect is or should have been discovered; and (2) if such continued use causes other or additional damage to the boat or component parts of the boat.
- (c) Regal will not be responsible to repair any condition or replace any part, (1) if the use of the boat is continued after the defect is or



Introduction

should have been discovered; and (2) if such continued use causes other or additional damage to the boat or component parts of the boat. (d) Based on the dealer's knowledge of Regal's warranty policy and/or consultations with Regal, the dealer will accept the claim and arrange for appropriate repairs to be performed, or deny the claim if it is not within the warranty.

(e) The dealer will contact the Regal boat owner regarding instructions for delivery of boat or part for warranty repair if it is covered by the limited warranty.

ALL COSTS TO TRANSPORT THE BOAT FOR REPAIRS ARE THE RESPONSIBILITY OF THE OWNER;

(f) If the Regal boat owner believes a claim has been denied in error or the dealer has performed the warranty work in an unsatisfactory manner, the owner must notify Regal's Customer Service Department in writing at the address listed for further consideration. Regal will then review the claim and take appropriate follow-up action.

WARRANTY EXCEPTIONS: THIS LIMITED WARRANTY does not cover and the following are not warranted:

- (a) Engines, metal plating or finishes, windshield breakage, leakage, fading and deterioration of paints, canvas, vinyl, upholstery and fabrics;
- (b) Gelcoat surfaces including, but not limited to, cracking, crazing, discoloration or blistering except as noted above;
- (c) Accessories and items which were not part of the boat when shipped from the Regal factory, and/or any damage caused thereby;
- (d) Damage caused by misuse, accident, galvanic corrosion, negligence, lack of proper maintenance, or improper trailering;
- (e) Any boat used for racing, or used for rental or commercial purposes;
- (f) Any boat operated contrary to any instructions furnished by Regal, or operated in violation of any federal, state, Coast Guard or other governmental agency laws, rules, or regulations;
- (g) The limited warranty is void if alterations have been made to the boat;
- (h) Transportation of boat or parts to and/or from the REGAL factory or service location;
- (i) Travel time or haul outs, loss of time or inconvenience;
- (j) Any published or announced catalog performance characteristics of speed, fuel and oil consumption, and static or dynamic transportation in the water;
- (k) Any boat that has been repowered beyond Regal's power recommendations;
- (l) Boats damaged by accident and boats damaged while being loaded onto, transported upon or unloaded from trailers, cradles, or other devices used to place boats in water, remove boats from water or store or transport boats on or over land;
- (m) Water damage to, dry rot to, condensation to, or absorption by interior surfaces, wood structures or polyurethane foam; interior wood including, but not limited to, bleeding and/or discoloration as a result of condensation or moisture or water continually contacting the plywood causing staining to upholstery, carpet or other interior surfaces;
- (n) Costs or charges derived from inconveniences or loss of use, commercial or monetary loss due to time loss, and any other special, incidental or consequential damage of any kind or nature whatsoever.

NO WAIVER OF THESE ITEMS: The terms, conditions, limitations and disclaimers contained herein cannot be waived except by the Customer Service Manager of Regal. Any such waiver must be in writing. Neither the dealer, nor the customer, nor any service, sales and/or warranty representative of Regal is authorized to waive and/or modify these conditions, limitations and/or disclaimers.

GENERAL PROVISIONS:

ALL GENERAL, SPECIAL, INDIRECT, INCIDENTAL AND/OR CONSEQUENTIAL DAMAGES ARE EXCLUDED FROM THIS WARRANTY AND ARE TOTALLY DISCLAIMED BY REGAL. IT IS THE INTEREST OF THE PARTIES THAT THE OWNER'S SOLE AND EXCLUSIVE REMEDY IS THE REPAIR OR REPLACEMENT OF THE VESSEL OR ITS ALLEGEDLY DEFECTIVE COMPONENT PARTS AND THAT NO OTHER LEGAL OR EQUITABLE REMEDIES SHALL BE AVAILABLE TO SAID OWNER. SOME STATES DO NOT ALLOW THE EXCLUSION OF INCIDENTAL OR CONSEQUENTIAL DAMAGES SO THE FOREGOING MAY NOT APPLY TO YOU. THIS IS A LIMITED WARRANTY; REGAL MAKES NO WARRANTY, OTHER THAN CONTAINED HEREIN;

TO THE EXTENT ALLOWED BY LAW ANY WARRANTIES OF MERCHANTABILITY OR FITNESS FOR A PARTICULAR PURPOSE ARISING IN STATE LAW ARE EXPRESSLY EXCLUDED TO THE EXTENT ALLOWED BY LAW. ANY IMPLIED WARRANTY OF MERCHANTABILITY IS LIMITED TO THE PERIOD OF THIS LIMITED WARRANTY. ALL OBLIGATIONS OF REGAL ARE SPECIFICALLY SET FORTH HEREIN. REGAL DOES NOT AUTHORIZE ANY PERSON OR DEALER TO ASSUME ANY LIABILITY IN CONNECTION WITH REGAL BOATS. Some states do not allow limitations on how long an implied warranty lasts, so the above limitation may not apply to you. Regal's obligation with respect to this warranty is limited to making repairs to or replacing the defective parts and no claim for breach of warranty shall be cause for cancellation or rescission of the contract or sale for any boat manufactured by REGAL MARINE INDUSTRIES, INC.

Regal will discharge its obligations under this warranty as rapidly as possible, but cannot guarantee any specific completion date due to the different nature of claims which may be made and services which may be required. Regal reserves the right to change or improve the design of its boats without obligation to modify any boat previously manufactured. This limited warranty gives you specific legal rights, and you may also have other rights which may vary from state to state. Regal shall in no way be responsible for any repairs not PRE-AUTHORIZED by a Regal Customer Service Manager or repairs performed by a repair shop not PRE-AUTHORIZED by a Regal Customer Service Manager.



Note

The information found in this owner's manual may change at any time. Designated items referred to may not be installed on your vessel. In keeping with its commitment to continued product improvement Regal Marine Industries, Inc. reserves the right to modify the vessel at any time without notice including changes in specifications, colors, fabrics, materials and equipment or to discontinue a model. Regal is not obligated to make similar changes or modifications to models sold prior to the date of such changes.

All specifications are approximate including weights, fuel figures and speeds.

Speeds are calculated at sea level with a temperature of 70 to 85 degrees. Increases in altitude and/or temperature will reduce horsepower and thereby reduce the speed of the vessel.

All information is for reference only and should be used as a guideline. Consult local and state guidelines as they may differ in your area. Any decisions relating to safe operation of the vessel are the responsibility of the operator.



Safety On Board





Safety awareness can not be over emphasized. Safety on board needs to be the skippers number one priority. In this manual you will find many safety precautions and symbols to identify safety related items. Heed all safety precaution information. Remember, the skipper is responsible for the safety of his passengers and crew.

SAFETY LABELS

SAFETY PRECAUTION DEFINITION

Safety precautions are stated as caution, warning and danger signal words. They are highlighted in this manual by font design and symbol usage. Also, a notice heading is included which provides operation and maintenance information but is not hazard-related. An information label provides tips on a variety of topics. Become familiar and understand all safety precaution labels!

	WARNING
Potentially hazardous situation that, if not avoided, could result in death or serious injury.	

	CAUTION
Indicates a potentially hazardous situation or unsafe practice that, if not avoided, may result in injury, property or product damage.	

NOTICE	
General or specific information which is important to correct operation or maintenance, but is not hazard related.	

	INFORMATION
Educational tips for the skipper and crew.	

	DANGER
Immediate hazardous situation that, if not avoided, will result in death or serious injury.	



PRECAUTIONARY LABELS

Read and understand all safety labels affixed to your Regal yacht or found in this manual and the vendor literature. Many of the safety labels are posted close to the helm, aft cockpit, cabin and swim platform. The location of the labels may vary.

Review the helm safety labels with passengers before disembarking.

Use common sense to analyze the result of an action on board your vessel. Always think safety first!

NOTICE

DO NOT REMOVE OR COVER
ANY PRECAUTIONARY LABELS.
KEEP HARSH CHEMICALS
AWAY FROM LABELS.
IF A LABEL BECOMES ILLEGIBLE,
CONTACT YOUR REGAL DEALER
FOR ORDERING A REPLACEMENT.

GENERAL BOATING SAFETY

We understand that you are eager to go boating. However, we strongly suggest that you thoroughly familiarize yourself and friends or members of your family with safe boating practices before setting out.

Remember, that along with the freedom and exhilaration of boating comes the responsibility that you have for the safety of your passengers and other boaters who share the water with you.

Boating regulations vary from state to state. Check with your local state and local authorities for the regulations pertaining to your area.

Check with local FM weather stations, U. S. Coast Guard, or on-line for the latest weather conditions. Remember getting caught in severe weather is hazardous. Check weather conditions periodically while you are boating. If you are forced to operate your boat in a storm condition, take common sense precautions; wear PFD's, store gear, reduce speed and if possible head for safe refuge.

It is best to avoid operating your boat in foggy weather. When fog sets in, take bearings, log courses and speeds. You are required to emit a five second blast from your horn or whistle once every minute. Also, have your passengers wear PFD's and observe for oncoming vessels.

Operation in shallow water presents a number of hazards including sand bars and water levels influenced by tides. If the vessel strikes an underwater hazard, check for boat and engine damage. If the engine vibrates excessively after striking an underwater obstruction, it may indicate a damaged propeller. If you run aground, seek help by radio or flares.

Make sure your boat and equipment are in top condition. Do this by frequently inspecting the hull, engine and propulsion components.



Safety On Board

You must provide a Coast Guard approved personal flotation device (PFD) for every person on board. These PFD's should be in good condition and easily accessible.

Insist that non-swimmers and children on board wear a PFD at all times. If you encounter rough weather conditions, make sure everyone on board is wearing a PFD, including yourself. Instruct your passengers in how to put on their PFDs and be sure they know their storage location on the boat. Remember, in an emergency, a PFD that cannot be quickly located and worn is useless.

Never allow anyone to sit anywhere on the boat not specifically designed as seating. While underway, ALWAYS insist passengers sit in a seat and set an example by doing this yourself.



Never drink and drive! As captain, you are responsible for the safety of your passengers. Alcohol and boating can be a dangerous combination. DO NOT mix them. Alcohol impairs the boat operators ability to make conscious decisions and react to emergency situations quickly.

Never overload your boat! An overloaded boat, or one with uneven weight distribution can be difficult to steer.

Use maximum caution when fueling. Never allow any smoke or flame nearby while you are fueling. ALWAYS check for fuel leaks and fumes when fueling is completed.



Be certain there is enough fuel aboard for your cruising needs. Include any reserve that might be needed should you change your plans due to weather or an emergency. Practice the "one-third rule: Use one-third of your fuel going out, one-third to return

and retain one- third as a reserve.

Always check the weather before departure. Be particularly cautious of forecasted electrical storms and high winds.

Always have up-to-date charts aboard as a back-up to your plotter and auto pilot option. Charts can be obtained at your closet marina, on-line store or by contacting one of three federal government agencies.

Always file a float plan. Leave details of your trip with someone responsible who will be remaining on shore. Include expected return, plus name and phone number of a contact person in case of emergency.

Use care, courtesy and common sense when launching, docking or operating your boat.

Learn and obey the "Rules of the Road". A weather resistant placard copy of the "Rules of the Road" is included in the on board Regal information packet. Additional information can be obtained from the U.S. Coast Guard Auxiliary or your local Power Squadron organization. In case of emergency know the international distress signals for your VHF radio. The spoken word "MAYDAY" is the international signal of distress and is for emergency use only. Under no circumstances should this word be used, unless there is danger at hand.



Posted speed limits, swimming areas, “no wake” zones and other restrictions should be red-flagged. They are so noted for a reason. Sensible boat use, plus courtesy, equals enjoyable and safe boating.

It is your responsibility to stay abreast of all federal, state and local rules, as some laws or regulations may change or be different from state to state. Contact your local boating agencies for updated information.

We can not stress safety enough! Remember, there are no brakes on your boat, and the water current and wind velocity both affect your ability to respond. The operator must use caution at all times to maintain control of his vessel and especially to keep a safe distance from other boats and obstacles.

Always keep all safety gear in optimum condition. Pay special attention to attached tags and plates indicating expiration dates on equipment such as fire extinguishers, and personal flotation devices. Encourage a periodic maintenance check on all safety equipment. Contact your Regal dealer or marine professional for more information. Again, remember that the captain is responsible for his crew, passengers and vessel.

REQUIRED SAFETY EQUIPMENT

PERSONAL FLOTATION DEVICES

All personal flotation devices (PFD's) must be Coast Guard approved, in good working condition, and must be the correct size for the wearer. All PFD's must be readily accessible. This means being able to wear them in a reasonable amount of time in case of an emergency (fire, boat sinking, etc.). They should not be stored or locked in closed areas. Also, make sure that all coverings are removed such as plastic from any PFD's. Throwable devices such as a ring buoy need to be available for immediate deployment. A PFD should be worn at all times when your boat is operating on the water. A PFD may save your life, but it must be worn to do so.

As a minimum U. S. Coast Guard requirement all recreational boats must carry one type I, II, III, or V PFD (wearable) for each person aboard. See the explanation following for each type. For type V to be counted they must be used according to the label instructions. In addition, all boats over 16' must carry one Type IV (throwable) PFD.

Some states require that PFD's be worn by children of specific ages at all times. Check with local and state boating agencies for particular requirements in your state before taking children on the water. Child life jackets are classified by the child's weight and should like all life jackets be sized before being purchased.

Remember PFD's will not necessarily keep you from drowning, even though they are designed to keep a person from sinking. When purchasing PFD's make sure it safely fits the person wearing it. It is a good idea to test PFD's in a lifeguarded shallow pool before venturing on the water.



Safety On Board

Refer to the USCG minimum equipment requirements at the end of this chapter. It is meant to be a guide only. Contact state and local agencies for additional equipment requirements. Remember as the captain of your vessel you are responsible for its safe operation.

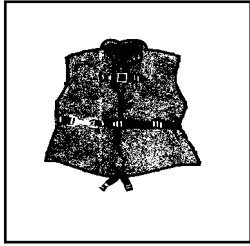

TYPE I- Also known as an off-shore jacket, it provides the most buoyancy. It is a PFD for all waters and is especially useful in rough waters where rescue may encompass additional time. It is designed to turn most unconscious users in the water to

a true face-up position. Type I PFD is available in adult & child sizes Buoyancy minimum poundages are 15.5 adult, 11 medium child, and 7 for small child and infants.

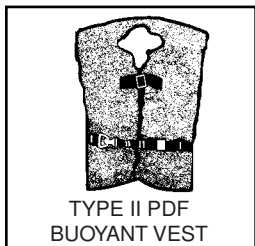

TYPE II- Also known as near-shore buoyant vest, it is recommended for calm, inland water where rescue time will be minimal. It will turn some unconscious people face-up in the water but not as numerous as Type I. They use the same buoyancy minimum poundages as the type I PFD's.

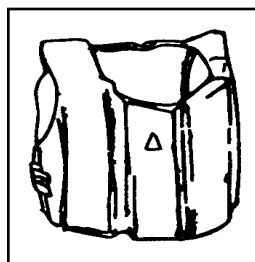

TYPE III- Known as a flotation aid it is good for calm, inland water or where there is a chance for quick rescue. It is designed so wearers can place themselves in a face-up position in the water. The wearer may have to tilt their head back to avoid face-down

positions. Type III offer the same buoyancy minimum poundages as the Type II. They are generally the most comfortable for continuous wear. Float coats, fishing vests, and vests featuring designs for various sport activities are examples of Type III.

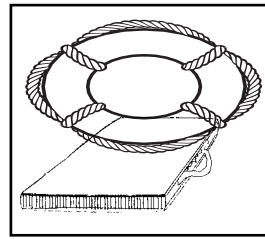

TYPE IV- Intended for calm, inland water with heavy vessel traffic, where help is constantly present. It is designed to be thrown into the water for someone to grab on to and held until rescued. It is not designed to be worn. Type IV includes ring buoys, buoyant cushions, and horseshoe buoys.

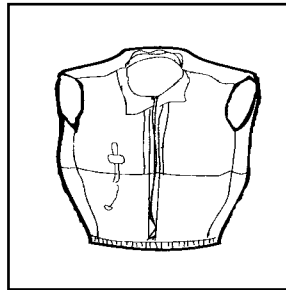

TYPE V- Also known as a special use device this is the least bulky of all PFD's. It contains a small amount of inherent buoyancy, and an inflatable chamber. It is rated even to a Type I, II, or III PFD (as noted on the jacket label) when inflated. Some Type V devices provide significant hypothermia protection. Varieties include deck suits, work vests, board sailing vests and Hybrid PFD's. Remember that this Type V type PFD may be carried instead of another PFD only if used according to the approval condition on the label.

Note: A water skier or wakeboarder is considered on board the vessel and a PFD is required for the purposes of compliance with the PFD carriage requirements. It is advisable and recommended for a skier or wakeboarder to wear a PFD designed to withstand the impact of hitting the water at a high speed. "Impact Class" marking on the label refers to PDF strength, not personal protection. Some state laws require a skier or wakeboarder to wear a PFD.



PFD'S FOR PETS

If you are a skipper who needs to have his pet dog or cat on board or dockside then a PFD is recommended. The PFD will aid you in finding the pet if it should fall overboard. The device must fit the pet properly. Also, it may take a bit of training before the pet is comfortable wearing the PFD. Normally, dogs are easier to train wearing a life vest than a cat.

Marine type retail stores will fit a pet to a PFD by body weight.

MAINTAINING YOUR PFD'S

A PFD is only useful if it is well maintained. Always be aware of PFD age since it has a life expectancy like any other piece of equipment.

✓ Check periodically for broken zippers, frayed webbing, water soaked kapok bags, missing straps, and sewing that has become undone.

✓ Clean each PFD with mild soap and water only. Again, let dry sufficiently before storing.

✓ Keep PFD's out of grease and oil since they can deteriorate the jacket inner and outer materials.

✓ Check any kapok-bagged jackets by squeezing. If you hear air escaping the bag is defective and the PFD should be thrown away.

✓ Grab the cover with the fingers. If the cover material rips, the PFD is rotted and should be thrown away.

✓ If the kapok bag is hard the PFD should be discarded.

FIRE EXTINGUISHERS

GENERAL INFORMATION

Fire extinguishers are classified by a letter and numeric symbol. The letter references the type of fire the unit is designed to extinguish.

For example, type B extinguishers commonly used on boats are designed to put out flammable liquids such as grease, oil and gasoline.

The number indicates the general size of the extinguisher (minimum extinguishing agent weight).

Coast Guard Approved extinguishers are identified by the following marking on the label:

“Marine Type USCG Approved, Size..., Type..., 162.028/.../”, etc.

FIRE EXTINGUISHER CONTENTS				
CLASS	FOAM IN GALS.	CO2 IN LBS.	DRY CHEM IN LBS.	HALON IN LBS.
B-I	1.25	4	2	2.5
B-II	2.5	15	10	10

MINIMUM PORTABLE FIRE EXTINGUISHERS REQUIRED		
VESSEL LENGTH	NO FIXED SYSTEM	WITH FIXED SYSTEM

LESS THAN 26'	1 B-1	0
26' TO LESS THAN 40'	2 B-1 OR 1 B-II	1 B-1
40' TO 65'	3 B-1 OR 1 B-1 & 1 B-II	2 B-1 OR 1 B-2



Safety On Board

U. S. Coast Guard approved fire extinguishers are required on all Regal yachts. Besides the minimum Coast Guard requirements always check state and local agencies for additional requirements and equipment.

Coast Guard approved extinguishers are hand-portable, either B-I or B-II classification. U. S. Coast Guard approved hand-portable and semi-portable extinguishers contain a metal plate that shows the manufacturers name and extinguisher type, capacity and operating instructions. Look for the section of the label that states "Marine Type USCG, type A, Size II, Type B, C Size I. It will also contain a USCG approval number. Make sure Type B is indicated. Hand portable extinguishers will be either Size I or II. They have a special marine type mounting bracket which keeps the extinguisher solidly mounted until needed. The extinguisher needs to be mounted in a readily accessible location but one that will not be bumped by people while underway. All approved extinguishers shall have an indication gauge.



■ The carbon dioxide unit uses CO2 gas under high pressure, with a funnel discharge hose usually swivel mounted. This extinguisher leaves no residue and does not cause interior engine harm. To ensure workability, weigh the unit annually. A 10% maximum weight

variance is allowed.

Another type of liquified gas used today is FE-241. This gas is colorless and odorless, heavier than air and sinks to the lower bilge to extinguish fires. Since the year 2000 ingredients have changed to a more environmental friendly formula (Chlorotetrafluoroethane or FE-241). FE-241 is used in portable-hand units along with making up the majority of boat automatic fire extinguishing systems. The canister needs to be weighed once a year. These clean agent units feature a dash mount indicator. Refer to the information regarding fire prevention in this manual.

U.S.C.G APPROVED FIRE EXTINGUISHER TYPES & FEATURES



■ The dry chemical agent is widely used because of its convenience and low cost. The extinguisher canister is filled with a white dry chemical powder along with a pressurized gas. It is a good idea to shake this type periodically because they tend to "pack" on the canister bottom.



■ The foam type uses a chemical foaming agent plus water and is best when used for fires involving flammable liquids- solvents, gasoline, oil, grease and various paints. It will work on fires involving rubber, plastics, cloth, wood, and paper. It leaves a messy residue. Do not use this extinguisher for electric fires.

VISUAL DISTRESS SIGNALS

All vessels used on coastal waters, any of the Great Lakes, territorial seas, and those waters connected directly to them up to a point where a body of water is less than two miles wide, must be equipped with Coast Guard approved visual distress signals.

Vessels owned in the United States operating on the high seas must be equipped with U.S.C.G. approved visual distress signals.



PYROTECHNIC DEVICES

Pyrotechnic visual distress signals must be Coast Guard approved, be ready for service and must be readily accessible. They all display a marking which is the service life, which must not have expired. A minimum of 3 devices are required for the day and 3 devices for night. Some devices meet both day and night requirements. Pyrotechnic devices should be stored in a cool, dry location. Most of these devices can be purchased in an highly visible (orange) watertight container. Types of Coast Guard approved pyrotechnic distress signals and associated devices are:

- Pyrotechnic red flares, hand-held or aerial type.
- Pyrotechnic orange smoke, hand-held or floating type.
- Launchers for parachute flares or aerial red meteors.

All in all, each distress signal has certain advantages and disadvantages.

There is no distress signal that is best under all situations. Pyrotechnics are recognized world-wide as superior distress signals. A downfall is they emit a very hot flame that can cause burns and or ignite flammable materials. Pistol launched and hand-held parachute flares operate consistant with firearms and therefore must be carefully handled. Check with local and state regulations since some of these device are considered firearms and are prohibited.

It is best to carry red aerial flares which are visible from a greater distance. Also, the red parachute flares burn for longer periods and therefore are more likely to be seen by another vessel.

NON-PYROTECHNIC DEVICES

Non-pyrotechnic devices must all be in serviceable condition, readily accessible, and must be certified by the manufacturer to comply with U. S. C. G standards. They include:

- Orange distress flag.
- Electric distress light.

The distress flag is for day use only. It must be 3 x 3 or larger with a black square and ball on an orange background. It can be spotted when attached to a boat hook, long fishing rod, or paddle with the person waving the flag back and forth overhead.

The electric distress light is for night use only flashing the international SOS distress signal (..._ _ _ ...).

Under Inland Navigation Rules, a high intensity white light that flashes at regular intervals from 50-70 times per minute is considered a distress signal.

Remember that regulations prohibit the display of visual distress signals on the water under any circumstances except when assistance is required to prevent immediate or potential danger to passengers on a vessel.



Safety On Board

INTERNATIONAL DISTRESS SIGNALS

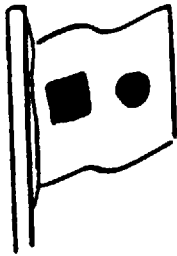

BLACK SQUARE
AND BALL ON
ORANGE BACKGROUND

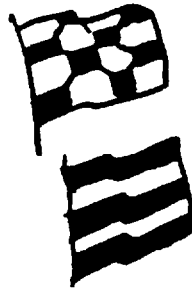

CODE FLAGS
NOVEMBER
& CHARLIE



SQUARE FLAG
& BALL



PERSON
WAVING
HANDS

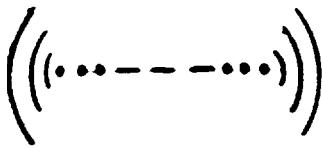

MORSE
CODE S.O.S.



"MAYDAY"
BY
RADIO

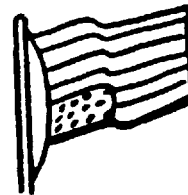

ENSIGN
UPSIDE
DOWN

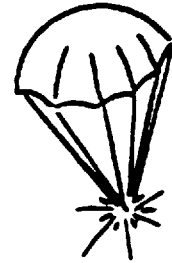

PARACHUTE
RED FLARE



RED METEOR
FLARES



SMOKE



FOG HORN
SOUNDED
CONTINUOUSLY



GUN FIRED AT
1- MINUTE
INTERVALS

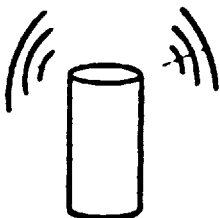

POSITION
INDICATING
RADIO BEACON



DYE MARKER
(ANY COLOR)

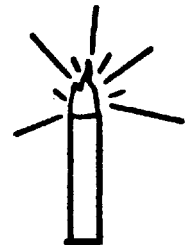

HAND-HELD
FLARE



SOUND PRODUCING DEVICES

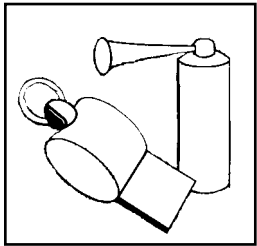

According to both Inland and International Rules, all boats must carry a way of producing an efficient sound signal. If your vessel is 12 meters (39' 4") or longer, a power whistle or power horn and bell must be carried. Bell mouth must be at least 7 7/8"

diameter.

The sound signal made in all cases must be capable of a four or six second blast audible for one half mile. See the section discussing bridge and whistle signals for more information.

RADIO COMMUNICATIONS

VHF radios are used for distress and ship to shore and ship to ship communications today. Learn the specialized messages such as Mayday, Mayday, Mayday. It is only used when life or vessel is in imminent danger.

Many of the more recent VHF's feature DSC capability which offers the ability to place and receive digital calls directly with vessels and shore stations including USA and Canadian Coast Guards. Channel 70 is reserved exclusively for DSC calls. Refer to the VHF owner's information since you need to establish a Mobile Maritime Safety Identity (MMSI) number before using the DSC feature. A MMSI number identifies each DSC radio, like a telephone number. The FCC requires a ship station license for all vessels equipped with a marine VHF radio.

NAVIGATION LIGHTS

The U. S. Coast Guard requires recreational boats operating at night to display navigation lights between sunset and sunrise along with other periods of reduced visibility.

Navigation lights help avoid collisions by improving the night visibility of vessels. Red and green directional lights, white stern lights, white masthead lights and white all-around lights must be displayed in specified positions, depending on boat size, and mode of operation.

The configuration of visible lights tells an operator the size, direction of travel and means of propulsion (sail, power, rowing or at anchor) of another vessel.

This helps both operators determine who has the right of way. Larger boats are required to carry bigger, brighter lights that are visible over longer distances. See the light requirement chart for pleasure craft.

MARINE SANITATION DEVICES

Recreational vessels under 65' with installed toilet facilities must have an operable marine sanitation device (MSD) on board. Vessels 65' and under may use Type I, II, or III MSD's. All installed MSD's must be U.S. Coast Guard certified. The MSD's are labeled to show conformity to the regulations.

NAVIGATION RULES

The navigation rules establish actions to be taken by vessels to avoid collision. They are divided into Inland/International. Operators of vessels 39.4' or more shall have on board and maintain a copy of the Inland navigation rules.



NAVIGATION LIGHT RULES

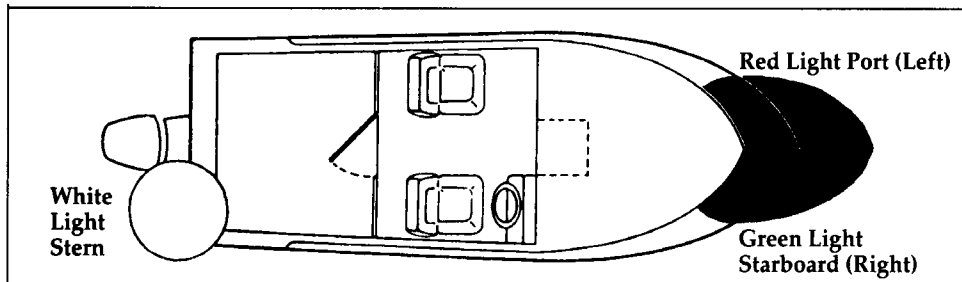

Location of lights on vessel	Visible Range		Degrees of arc lights
	Less than 12 m.	12 m. but less than 20 m.	
Masthead	2	3	225°
All-round	2	2	360°
Side lights	1	2	112.5° each color
Stern light	2	2	135°

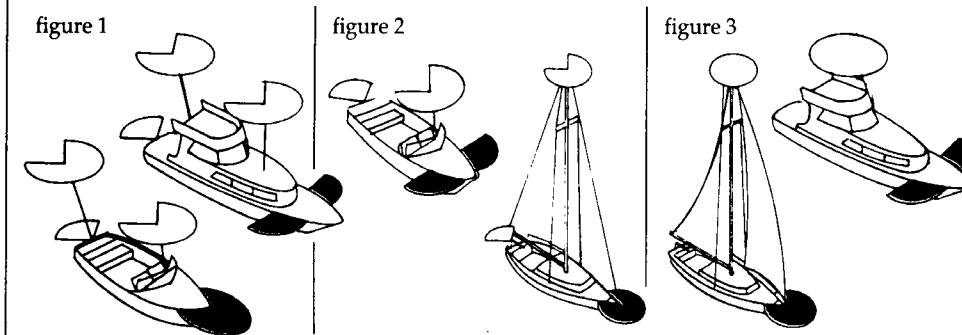

Boats less than 12 meters in length
Motorboats or sailboats using power: The lighting arrangements to figure 1, 2 or 3 may be used.
Sailboat using sails alone: The lighting arrangements in figure 4, 5 or 6 may be used.

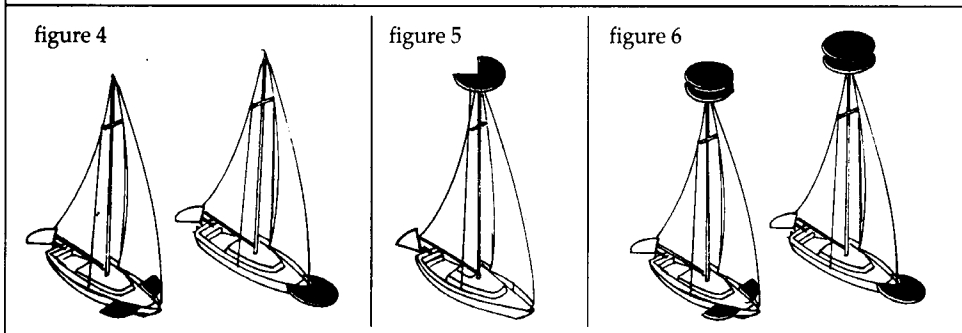

Boats 12 meters but less than 20 meters in length
Motorboats or sailboats using power: The lighting arrangements to figure 1 or 2 may be used.
Sailboat using sails alone: The lighting arrangements in figure 4, 5 or 6 may be used.

Location of lights
 Lights should be located as shown in the drawings.

The masthead light (forward white light in figures 1, 2 and 7d) must be at least one meter higher than the colored lights on a boat less than 12 meters in length and at least 2.5 meters above the gunwale on a boat 12 meters but less than 20 meters in length.

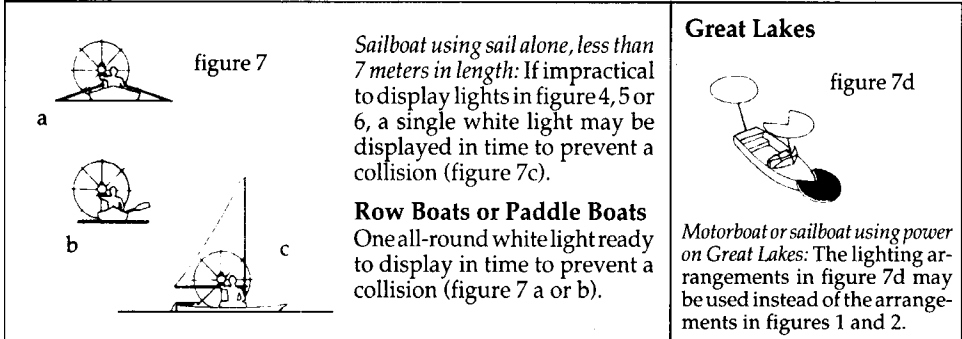

Sailboat using sail alone, less than 7 meters in length: If impractical to display lights in figure 4, 5 or 6, a single white light may be displayed in time to prevent a collision (figure 7c).

Row Boats or Paddle Boats
 One all-round white light ready to display in time to prevent a collision (figure 7 a or b).

Great Lakes

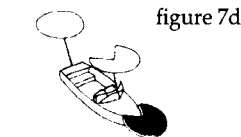

Motorboat or sailboat using power on Great Lakes: The lighting arrangements in figure 7d may be used instead of the arrangements in figures 1 and 2.

Exceptions
Motorboat or sailboat using power, built before December 24, 1980: The lighting arrangement in figure 1, 2 or 3 may be used. However, the arrangement in figure 3 is not acceptable on a boat that is 12 meters or longer on international waters.



POLLUTION REGULATIONS

NOTICE

DISCHARGE OF OIL PROHIBITED
THE FEDERAL WATER POLLUTION CONTROL
ACT PROHIBITS THE DISCHARGE
OF OIL OR OILY WASTE
INTO OR UPON THE NAVIGABLE WATERS
AND CONTIGUOUS ZONE
OF THE UNITED STATES IF SUCH DISCHARGE
CAUSES A FILM OR SHEEN UPON,
OR DISCOLORATION OF THE SURFACE
OF THE WATER, OR CAUSES A SLUDGE
OR EMULSION BENEATH THE SURFACE
OF THE WATER.

VIOLATORS ARE SUBJECT TO
A PENALTY OF \$5,000

MARPOL TREATY

The USCG now enforces the International Convention for the Prevention of Pollution from ships, referred to commonly as the MARPOL TREATY (marine pollution). This international treaty prohibits the overboard dumping of all oil, garbage, ship-generated plastic and chemicals. There is a placard on board your boat (typical example shown below) that explains the garbage and plastic dumping laws in detail.

Immediately notify the USCG if your vessel discharges oil or hazardous substances in the water. Call toll free 1-800-424-8802. Report the following information: location, source, size, color, substances and time observed.

No vessel may intentionally drain oil or oily waste from any source into the bilge of any vessel. A bucket or bailer is suitable as a portable means of discharging oily waste. The placard noted above is normally located in the engine or may be attached to the engine hatch.



GARBAGE DISCHARGE

The act to prevent pollution from ships places limitations on the discharge of garbage from vessels. It is illegal to dump plastic trash anywhere in the ocean or navigable waters of the United States. Also, it is illegal to discharge garbage in the navigable waters of the United States, including the Great Lakes. The discharge of other types of garbage is allowed outside certain specified distances from shore as determined by the nature of that garbage. United States vessels of 26 feet or longer must display in a prominent location, a durable placard at least 4" x 9" notifying crew and passengers of discharge restrictions. USA vessels of 26' or longer equipped with a galley and berthing must have a written Management Plan describing the plan for collecting, processing, storing and discharging garbage, and designate the person charged with carrying out the plan.

The placard noted below is usually found on the interior side of a galley door at a refreshment center.

THE DISCHARGE OF PLASTIC OR GARBAGE WITH PLASTIC INTO ANY WATERS IS PROHIBITED. THE DISCHARGE OF ALL GARBAGE IS PROHIBITED IN THE NAVIGABLE WATERS OF THE UNITED STATES AND IN ALL OTHER WATERS, WITHIN THREE NAUTICAL MILES OF THE NEAREST LAND.		
THE DISCHARGE OF DUNNAGE, LINING, AND PACKING MATERIALS THAT FLOAT IS PROHIBITED WITHIN 25 NAUTICAL MILES FROM THE NEAREST LAND.	OTHER UNGROUND GARBAGE MAY BE DISCHARGED BEYOND 12 NAUTICAL MILES FROM THE NEAREST LAND.	OTHER GARBAGE GREATER THAN ONE INCH MAY BE DISCHARGED BEYOND THREE NAUTICAL MILES FROM THE NEAREST LAND.
A PERSON WHO VIOLATES THE ABOVE REQUIREMENTS IS LIABLE FOR A CIVIL PENALTY OF UP TO \$25,000, A FINE OF UP TO \$50,000, AND IMPRISONMENT FOR UP TO FIVE YEARS FOR EACH VIOLATION, REGIONAL, STATE, AND LOCAL RESTRICTIONS ON GARBAGE DISCHARGES MAY ALSO APPLY.		



LIFE RAFTS

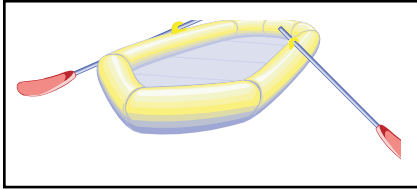

Inflatable life rafts are recommended for ocean going and vessels operating in a large body of water like the Great Lakes.

They provide a shelter for extended periods. If used, make sure it is large enough for all aboard and contains the proper emergency equipment pack. Also, periodically have the unit professionally serviced. Make sure the life raft is Coast Guard approved since it would require meeting a number of stringent material and performance standards.

USCG MINIMUM EQUIPMENT REQUIREMENTS

Use the chart below as a guideline for assuring your vessel is outfitted to meet USCG standards. Remember to check with local and state authorities for additional equipment requirements. Make sure your vessel certificate of numbers are on the boat, updated and displayed properly according to state requirements. Keep the paperwork on board in a watertight and safe environment. Make sure it is quickly accessible.

On documented vessels keep both the original and current certificate on board stored in a safe, dry, and accessible location. Also, on documented vessels make sure the vessel name/hailing port are marked on the hull exterior with letters not less than 4" in height. In addition, the Official Number must be permanently affixed on a clearly visible interior structure part of the boat-block type Arabic numbers not less than 3" in height.

USCG Minimum Equipment Requirements for Recreational Vessels					
Boat Size in Feet	16'	26'	40'	65'	165'
Personal Flotation Devices¹	One Type I, II, III, or V per person		One Type I, II, III, or V per person plus one Type IV throwable		
Fire Extinguishers²	One B-I, any type		One B-II or Two B-I	One B-II and one B-I, or three B-I	One or more B-II (vessels 0-50 tons gross) Two or more B-II (vessels 50-100 tons gross)
No Fixed System			One B-I	Two B-I or one Class B-II	
With Fixed System	No Portables Required				
Visual Distress Signals	Night signals required when operating at night		Minimum of three day-use and three night-use (or three day/night combination) pyrotechnic devices ⁵		
Sound Producing Devices	Horn or whistle recommended to signal intentions or signal position		One bell, and one whistle or horn required to signal intentions or position		
Backfire Flame Arrestor	One CG-approved device on each carburetor of all gasoline-powered engines built after April 1940, except outboard motors				
Ventilation	CG standard system required on gasoline powered vessels with enclosed engine compartments built after August 1980				
Navigation Lights	Sidelights, Stern Light and Masthead ^{6,7}				
Under Power ^{3,4}	Sidelights and Stern Light ^{6,8}				
Under Sail	Same as "Under Sail"				
Rowing	All-round light, 2nm (at night) or black anchoring ball (during the day) when outside a designated anchorage				
At Anchor	1nm Sidelights, 2nm all others				
Visibility Range	5" x 8" Oil Discharge placard and 4" x 9" Waste Discharge placard		Vessels over 40' with a galley must have a Waste Management Plan		
Pollution Regulations	"Honor system" (no plaques required)		Type II or III MSD only		
Marine Sanitation Devices	Vessels with installed toilet facilities must have an operable, CG-certified Type I, II or III Marine Sanitation Device (MSD). Subject to local laws!				
Navigation Rules	Familiarity with the Inland Navigation Rules required		The Inland Navigation Rules ("Rules of the Road") must be kept on board		

1. Pfd's must be CG approved, wearable by the intended user and readily accessible.
2. Fire extinguishers required on boats with enclosed engine compartments (not outboards), enclosed living spaces or permanent fuel tanks.
3. Sailboats operating under engine power are considered power driven and must follow the "Under Power" rules. During the day, motorsailing vessels are required to fly a motoring cone.
4. Power-driven vessels under 23' and under 7 knots can substitute a white lantern or torch in place of the required lights.
5. Non-pyrotechnic substitutes: 1 orange distress flag (day-use) and 1 electric SOS signal light (night-use).
6. All boats under 65' can substitute a single bi-color light for sidelights.
7. Boats under power under 40' can substitute a single all-round light for separate stern and masthead lights.
8. Boats under sail under 40' can substitute a tri-color light for separate sidelights and stern light.

Additions to these requirements are prescribed by some individual state laws. Check your state's Boating Safety Handbook for a complete list.



Safety On Board

EXHAUST & CARBON MONOXIDE

Carbon monoxide (CO) in exhaust can be hazardous, especially from gasoline engines, gasoline generators, grills, stoves, space heaters and on a much smaller degree diesel engines.

CO is a natural by-product of the gasoline engine using an artificial spark. Diesels on the other hand detonate fuel using pressure and temperature. Looking at the two engines another way, gasoline engines use much more oxygen up in the combustion process which contributes to a much higher CO build-up. Although diesels do produce a small amount of CO the combustion process operates with much greater amounts of oxygen which the end result is a much lower CO level.

In conclusion, even though your yacht may use diesel propulsion ensure that you read the information and follow all the recommendations regarding CO as if it were gasoline powered.

Familiarize your crew, passengers and yourself with the sources, symptoms and possible effects of carbon monoxide poisoning. Remember that gasoline boats in the same general vicinity especially using generators overnight can cause your vessel to accumulate dangerous CO levels in the cabin and or under the hardtop operating with the above conditions and sources.

For safety sake avoid the following:

1. Do not park by other boats with their engine idling or generator cycling for an extended period of time.
2. Do not disable the carbon monoxide alarms that come with your Regal boat. Test the units in accordance with the alarm manufacturers instructions.
3. Do not operate an engine for extended periods of time while in a confined area or where exhaust outlets face a sea wall or bulkhead.
4. Do not operate the engine for an extended period of time with the canvas in the upright and installed position.
5. Have the engine exhaust system inspected when the boat is in for service.
6. Persons sleeping can easily be overcome by carbon monoxide without realizing it. Do not sleep on board while an engine or generator is running close-by.
7. Do not operate your vessel for extended periods with the bow up in slow cruise conditions especially close behind a vessel being towed or one operating at slow speeds.
8. When underway open all hatches, windshield vents, and main cabin entry door to allow proper airflow from bow to stern.

	WARNING
AVOID SERIOUS INJURY OR DEATH FROM CO POISONING! DO NOT OPERATE THE BOAT WITH PEOPLE HOLDING ON TO THE SWIM PLATFORM OR WITH PEOPLE IN THE WATER.	

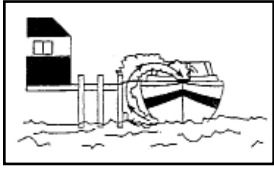

Blockage of exhaust outlets can cause carbon monoxide to accumulate in the cabin and cockpit area even when the hatches, windows, portholes and doors are open. Sea walls and other confined spaces can cause CO levels to be dangerously elevated.

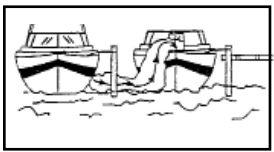

Exhaust from another vessel alongside your boat, while docked or anchored, can emit poisonous CO gas inside the cabin and cockpit areas.

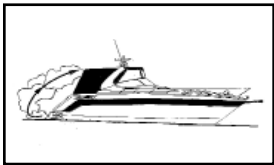

The “station wagon effect” or back drafting can cause CO gas to accumulate inside the cabin, cockpit/hardtop or bridge areas when the boat is under-way, using protective weather coverings (canvas), high bow angle, improper or heavy loading, slow speeds, or at rest. This can occur when traveling behind another boat.

How does CO affect us?

In high concentrations, CO can be fatal in minutes. However, the effects of lower concentrations over a extended period of time can be just as lethal.

Our blood uses hemoglobin to carry the oxygen we breathe to different body parts. Unfortunately, hemoglobin carries CO more readily than it does oxygen. The result is when we breathe in CO it replaces oxygen in our blood and we begin to suffocate. Also, when we are removed from the CO source it remains in our blood for hours causing long term effects. People have been known to become sick and even lose consciousness hours after exposure.

Carbon monoxide accumulation requires immediate attention! Thoroughly ventilate cabin and cockpit areas. Determine the probable source of the carbon monoxide and correct the condition immediately. Anyone with symptoms of CO poisoning should be placed in a fresh air environment and medical attention found immediately. Regal has installed CO detectors on your boat. Have these detectors professionally calibrated at regular intervals according to the equipment manufacturer’s recommendations.

A Few Notes About Diesel/CO Poisoning

The diesel engine under normal combustion produces much smaller amounts of CO. Therefore, it is far less likely to be fatal to a healthy person. Other factors including weather, temperature and engine condition can greatly affect the unsafe build-up of CO. The best approach is to respect and treat the engine, generator and other vessel components the same way you would a gasoline propulsion system giving particular attention to the sources and possible effects of CO poisoning!

Diesel exhaust in the combustion process produces various components and the captain must be aware that the build-up of these select components over a period of time can cause CO or seasickness like symptoms.

These include carbon dioxide, carbon monoxide (CO), nitrogen dioxide, nitric oxide, sulfur dioxide and others. A healthy person breathing in sulfur dioxide over a period of time through a diesel engine or generator exhaust can develop nausea. This condition is not life threatening but the person may exhibit CO poisoning or seasickness symptoms. Just never rule out that it could be CO poisoning! Immediately find the source of the problem and move the individual to a fresh air environment!



Safety On Board

Symptoms of excessive exposure to carbon monoxide (CO) are:

- Dizziness
- Drowsiness
- Nausea
- Headache
- Ringing in the ears
- Throbbing temples
- Watering, itchy eyes
- Flushed appearance
- Inattentiveness
- Incoherence
- Fatigue or vomiting
- Convulsions

DANGER

CARBON MONOXIDE IS A TASTELESS, ODORLESS AND INVISIBLE GAS THAT CAN CAUSE DISCOMFORT, SEVERE ILLNESS, AND EVEN DEATH. EXERCISE CAUTION WHILE OPERATING GENERATOR OR ENGINES IN CONFINED SPACES OR AT DOCKSIDE. DO NOT ALLOW HULL EXHAUST OUTLETS TO BECOME BLOCKED OR EXHAUST FUMES CAN BECOME TRAPPED IN AND AROUND THE CONFINES OF YOUR BOAT. DURING IDLE AND SLOW CRUISE CONDITIONS, BILGE BLOWERS SHOULD BE USED.

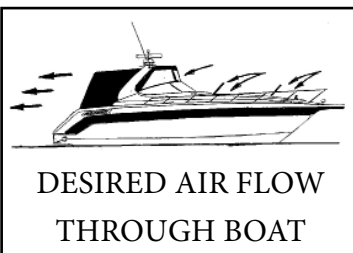

To help prevent carbon monoxide accumulation, ventilate your cabin and cockpit while underway. Open a forward hatch, porthole or window to allow air to travel through the boat's interior and cockpit. See the illustration for desired airflow.

WARNING

INSPECT THE EXHAUST SYSTEM. IMMEDIATELY REPAIR OR REPLACE LEAKING, CRACKED AND CORRODED, OR MISSING EXHAUST COMPONENTS.

- Before each trip inspect engine and generator.
- Make sure all exhaust hose clamps are in place and secure.
- Look for exhaust leaking from the exhaust system components, indicated by rust and or black streaking, water leaks, or corroded or cracked fittings.
- Inspect all rubber exhaust hoses for burned or cracked areas. All rubber hoses should feel soft and be free of kinks.
- Visually verify that water exits at the engine exhaust outlet.
- Keep an ear tuned for any change in exhaust sound that could indicate an exhaust component malfunction.

DO NOT OPERATE THE VESSEL IF ANY OF THE ABOVE CONDITIONS EXIST. CONTACT A MARINE PROFESSIONAL!

NOTICE

CARBON MONOXIDE PRECAUTIONARY LABELS ARE LOCATED AT THE HELM, TRANSOM, AND CABIN. ENSURE THAT ALL ABOARD READ AND UNDERSTAND THE SIGNS AND EFFECTS OF CARBON MONOXIDE (CO).



CARBON MONOXIDE DETECTORS

At Least Annually

Your Regal yacht features designated sleeping accommodations along with galley sink and head compartments.

With diesel propulsion and diesel generation a CO detector is not required but “common sense” tells us we need to have them installed on board. They are standard equipment on your Regal diesel yacht. Mooring by boats running gasoline generators along with vessels using gas cooking/grilling/heating devices could lead to dangerous levels of carbon monoxide on your boat.

Always be aware of other vessels mooring close to you especially if you are staying on board overnight. Read the owner’s manual and vendor information regarding the CO detectors installed on your vessel.

Follow the periodical service recommendations per the vendor regarding recalibration of the carbon monoxide detector. Never attempt to repair a CO detector yourself. Get to know the signs of carbon monoxide poisoning.

To be performed by a marine professional:

- Replace exhaust hoses or mufflers if any evidence of cracking, charring or deterioration is found.
- Replace the engine water pump impeller along with the plate and housing if necessary. This will help prevent cooling system and exhaust system overheating.
- Inspect each of the metallic exhaust components for cracking, rusting, leaking or looseness. Pay detailed attention to the exhaust manifold, cylinder head, water injection elbows.

Remember that carbon monoxide (CO) is known as the silent killer.



Safety On Board

BOATING & ALCOHOL

WARNING

FEDERAL LAWS PROHIBIT OPERATING A VESSEL UNDER THE INFLUENCE OF ALCOHOL OR DRUGS. THESE LAWS ARE VIGOROUSLY ENFORCED BY ALL ENFORCEMENT AGENCIES.



Operating a vessel while intoxicated became a specific federal offense effective in 1988. The ruling set federal standards for determining when an individual is intoxicated. If the blood alcohol content

(BAC) is .10% (.08 in some states) or higher for operators of recreational vessels being used only for pleasure are subject to a civil penalty up to \$1,000 or criminal penalty up to \$5,000, one year imprisonment or both. In some states the fines and imprisonment may increase significantly.

The effects of alcohol and drugs account for the highest single cause of marine accidents and deaths. Most deaths in boating accidents occur when someone falls into the water. Balance is one of the first things you lose when drinking alcohol or under the influence of drugs. The problem arises out of not knowing your balance is restricted.

Overall vision is reduced by alcohol especially at night, along with double or blurred vision. Peripheral vision is lessened which restricts seeing vessels or objects on the side. Also, color awareness decreases especially with red and green which happen to be the colors of boat navigation lights, buoys, and channel markers.

Alcohol will greatly increase your heat loss so it increases the effects of hypothermia. Finally, your ability to make correct judgements in emergency situations is greatly reduced. Alcohol takes away the brains ability to process information quickly and delays a persons reaction time. Don't drink and drive!!!!!!!!!!!!!!!!!!!!!!!!!!!!!!!!!!!!

ALCOHOL MYTHS AND FACTS

Myth: Beer is less intoxicating than other alcoholic beverages.

Fact: One 12 oz. can of beer has about the same amount of alcohol as a 5oz. glass of wine or a shot of liquor.

Myth: Black coffee, fresh air, and a shower will sober the effects of alcohol.

Fact: After consuming alcohol time is the only thing that will sober you up. Our bodies average burning 1 oz. of alcohol every hour. If a person is drunk, it will take a person seven or more hours to sober up.

Myth: Telling if a person is too drunk to operate a vessel is easy.

Fact: Many experienced drinkers have learned to compensate for the visual effects of alcohol and can disguise their drunk condition.

Myth: You can judge if you are fit to operate a boat.

Fact: Judgement is one of the first elements you lose when drinking.



BOATING ACCIDENTS

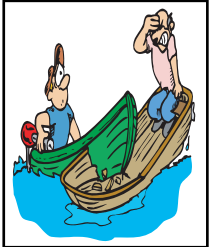

The following is a list of common causes of boating accidents. Be aware of them and take the necessary steps to ensure that yourself and crew are educated and prepared to act in an emergency.

1. Mixing boating and alcohol. Remember, the skipper is responsible for his crew, passengers and vessel.
2. Trying to reach the bow by the deck walk-around at unsafe speeds. Use the center walk-through.
3. Someone sitting on the bow, deck, or swim platform while underway.
4. Choosing a boating outing day with inclement weather, especially in high winds and thunderstorms in the forecast or staying out when bad weather is approaching.
5. Disembarking without checking all the fluids or systems, and especially fuel system components.
6. Not monitoring the boating traffic or possible obstructions around you.
7. Emergency communications equipment, signaling devices, and navigation lights not working.
8. Improper boat handling especially high speed turns in rough water. Using trim improperly.
9. Being too far from shore with inadequate fuel supply or navigational aids.
10. Passengers, especially children that are not wearing the proper life saving devices.
11. Skipper or passengers not seated in the boat.

REPORTING BOATING ACCIDENTS

According to the Federal Boat Safety Act of 1971 involving collision, accident or other casualty, the operator must make a formal report within 48 hours to the nearest state boating authority when the incident involves:

1. Death
2. Injury requiring treatment other than first aid
3. The disappearance of someone from a boat under death or injury circumstances.

A formal report must be made within 10 days for accidents involving more than \$2000 damage or complete loss of vessel.

For information regarding accident reporting call the Boating Safety Hotline at 800-368-5647.

If there is no state provision for reporting boating accidents a report must be made to the Coast Guard officer in charge, Marine Inspection Unit nearest to the accident site or USCG station.

RENDERING ASSISTANCE

The operator of a vessel is obligated by law to provide assistance that can be provided safely to any individuals in a dangerous situation on the waterway. The operator is subject to fine and or imprisonment for failure to do so.

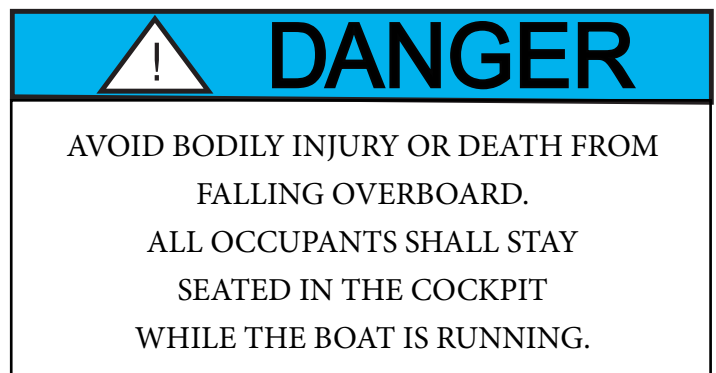



LAW ENFORCEMENT

A vessel when hailed by a Coast Guard vessel is required to heave to or maneuver as directed so as to permit a boarding team to come aboard.

Other federal, state, and local maritime law enforcement officials may also board and examine your vessel, whether it is numbered, unnumbered, or documented. U.S. Coast Guard law enforcement personnel work with and may also be found aboard other agencies' enforcement vessels.

The U.S. Coast Guard may impose a civil penalty for failure to:

- Comply with equipment requirements.
- Report a boating accident
- Comply with other federal regulations.
- Comply with Navigation Rules.

NEGLIGENT OPERATION

Federal law prohibits the negligent or grossly negligent operation of a vessel and/or interference with the safe operation of a vessel so as to endanger lives and/or property. The U.S. Coast Guard may impose a civil penalty for negligent operation. Grossly negligent operation is a criminal offense and an operator may be fined up to \$5,000.00, imprisoned for one year or both.

Some actions that may constitute negligent or grossly negligent operation are:

- Operating a boat in a designated swimming area.
- Excessive speed in the vicinity of other boats or in regulated waters.
- Hazardous water skiing or other water sport practices.
- Bow riding, or riding on seatback, gunwale or transom.
- Operating a boat while under the influence of alcohol or drugs.



WATER SPORTS

Besides learning the safety precautions for safe boating, as well as understanding and knowing required rules and regulations, you are obligated to be particularly careful around other water sportsman, such as scuba divers, water skiers, wake boarders, and fisherman.

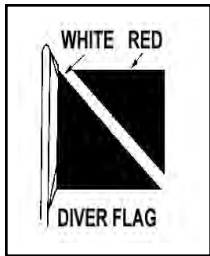

Whenever you see a “Diver Down” flag, maintain a distance of at least 100 feet on inland waters. In bays and open waters stay 300 feet away. The flag indicates a diver in the water. If a diver is operating from your boat, be certain to use this flag and post a lookout on board to observe the

diver’s air bubbles.

SWIM PLATFORM

On integrated or extended swim platforms you should make periodic inspections of the swim ladder and hardware that supports the platform to ensure that all connections and fittings are tight and in good condition. Use heed when operating the boat in reverse to insure that water does not accumulate excessively on the platform or transom, especially in rough seas or strong currents. Do not exceed the platform recommended maximum capacity label!



Typical label shown. Read and understand the following warning label regarding “teak surfing.”

WARNING

AVOID SERIOUS INJURY OR DEATH!

DO NOT OPERATE THE BOAT
WITH PEOPLE IN THE WATER
ON TOP OR HOLDING ON TO
THE SWIM PLATFORM STRUCTURE.

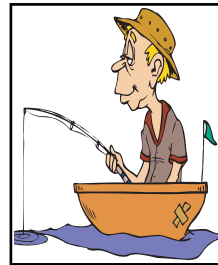

Most boaters fish from time to time. With the propulsion systems of today it is possible to fish in out-of-the-way places. When cruising, stay clear of fisherman. They may have lines or nets out which might be cut or get caught in your propeller if you come too close. Slow down when

approaching fishing boats. Do not return to cruising speed until the boats have been passed. If a fishing boat should be anchored, a large wake could flip or swamp the boat, upset fishing gear, pull the anchor loose from the bottom or worse yet cause someone to fall overboard. When fishing from your boat, never anchor in a shipping channel or tie up to any navigational aid. These must be kept clear of at all times.

Be sure to carry a local chart of the area to back up your plotter and be on the lookout for shallow water and hidden obstructions. Many times local conditions change and there is a time lag on the plotter chip until the next revision.

Pick up a tidal chart if appropriate so you do not end up grounded.



Safety On Board

WEATHER/WATER CONDITIONS

Before a boating outing check the weather conditions. As we all know the weather can change rapidly in many parts of the country. It does so sometimes without being predicted. NOAA weather radio reports are continuously available on designated frequencies installed on VHF radios and various handhelds. Also, many local radio stations carry weather reports along with on-line information.

CLOUD FORMATIONS

Clouds indicate the type of current weather and upcoming changes in the weather. Knowing the type of cloud formation can assist you in understanding current weather. Flat clouds (stratus) normally indicate stable air. Cumulus clouds indicate unstable air. Many times a “cottonball” or cumulus cloud builds vertical height in the afternoon and the result is a thunderstorm with increased winds and waves; sometimes these storms are quite violent. Also, water spouts with high vortex winds can develop over water. You can find additional weather information (meteorology) at your local library or on the internet.

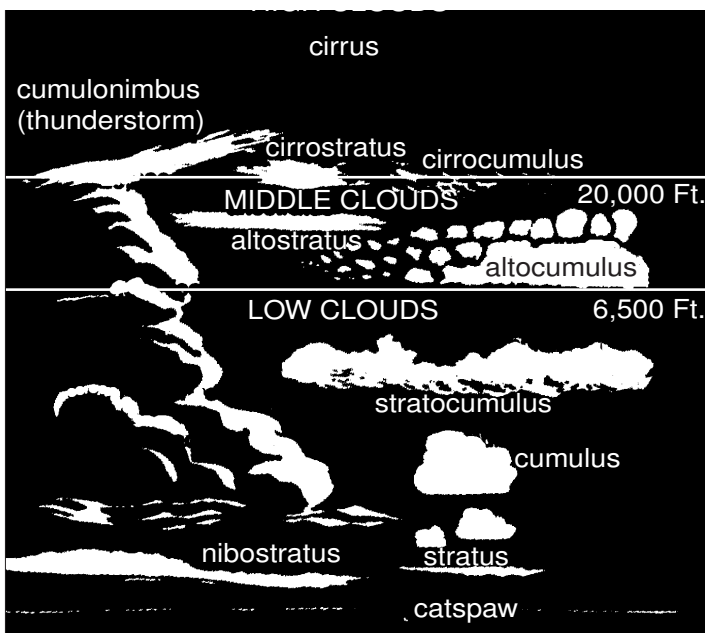

WAVES & FOG



As the wind blows across water waves are created. The stronger the wind and increased distance across the water enlarges the wave action.

Other factors that can cause problem situations for vessels are fog, currents, and tidal changes.

Fog can develop inland on clear, calm mornings. Coastal areas see large “blankets” of fog roll in and stay for extended time periods sometimes causing hazardous navigation conditions. If you are caught in the fog, do not panic. Think of the best plan of action and proceed carefully. If you are limited in navigation equipment at the first sign of fog proceed to the nearest shoreline and wait until the fog lifts.

Boats equipped with navigation equipment, local waterway experience and charts should proceed to a safe harbor. Use extreme caution, signal as needed, and reduce to a speed where you can stop within half of your forward vision range.

If foul weather catches you at sea do the following:

1. Slow down. Proceed with caution and put on your life vests.
2. Try to reach the nearest safe shoreline.
3. Navigate your vessel slowly into the waves at a 45 degree angle.
4. Passengers should sit low in the center of the vessel.
5. Monitor your bilge pump. Make sure sump stays free of water.
6. Secure loose gear. Make ready emergency equipment.
7. If the engine stops, throw the anchor over the bow. If needed use a sea anchor. Never anchor off the stern.



Rules Of The Road

NAVIGATION RULES DEFINED



The Navigation Rules set forth actions to be followed by boats to avoid collision. They are referred to as the “Rules of the Road”. There are two main parts referred to as the inland and

international rules. The inland rules apply to vessels operating inside the boundaries of the United States. The international rules (referred to as 72 COLREGS) apply to vessels operating on the high seas and all connected waters outside the established demarcation boundaries. Most navigational charts show the demarcation lines by red dotted lines and are published in the navigation rules. Remember to consult state and local agencies since areas such as “no wake zones,” swimming beaches, “diver down flag” and inland landlocked lakes fall under their jurisdiction. This section is only an introduction to the “rules of the road”. We strongly recommend additional training before getting behind the “wheel” of your boat.

NOS nautical charts may be purchased directly by mail from the NOS Distribution Branch or through an authorized agent. There are more than 1,700 nautical chart agents that sell NOS charts. Use the address and contact numbers below to obtain a list of agents near you or to request a free catalog.

FAA, National Aeronautical Charting Office
Distribution Division, AJW-3550
10201 Good Luck Road
Glendale, MD 20769-9700
Tel (301)436-8301 or (800) 638-8972
Fax (301)436-6829
E-mail: 9-AMC-chartsales@faa.gov
Website: www.naco.faa.gov/ecom

NAVIGATION RULES

RIGHT OF WAY

1. Cross waves at right angles.
2. When caught in heavy water or squalls, head either directly into the waves or at a slight angle. Reduce speed, but maintain enough power to maneuver your boat safely.
3. Keep your speed under control. Respect the rights of other boaters engaged in all water sports. Give them plenty of operating room.
4. Whenever meeting a boat head on, keep to the right where possible.

 **WARNING**

TO AVOID INJURY AND DEATH
FOLLOW THE NAVIGATION “RULES OF THE
ROAD” TO PREVENT COLLISIONS.



5. When two boats cross, the boat to the right (starboard) has the right of way.
6. When overtaking or passing, the boat being passed has the right of way.

In general, boats with less maneuverability have right-of-way over more agile craft. The skipper must keep his craft clear of the following vessels:

- A vessel not under command or aground; due to their circumstances, these vessels have no maneuverability.
- A vessel restricted in its maneuverability; these vessels usually are performing work which limits their maneuverability. Examples are boats surveying, dredging, laying pipe or cable, or servicing navigational markers.
- A vessel engaged in fishing; these include boats fishing with lines, trawls or nets, but not trolling lines.
- Sailboats; they have the right-of-way over powerboats. However, if a sailboat is using a prop to move forward, it is considered a powerboat even if the sails are up.
- Remember the unwritten “rule of tonnage”. Basically a smaller tonnage vessel should take every effort to avoid close quarters with a larger tonnage vessel. One way to accomplish this is to have a designated human lookout to “eyeball” the horizon for any developing collision course.
- Use defensive driving skills on the waterway just as you do on the roadway. The other vessel may not know the “rules of the road”. Be alert and ready to take immediate action.
- If a collision course is unavoidable neither boat has the right of way. Both boats must react to avoid an accident according to the rules of the road.

LOOKOUTS

International and Inland navigation rules spellout the specifics of establishing a lookout. A lookout is legally defined by the court system as a person who has specifically charged duties on board such as observing sounds, echoes, lights and any inhibitors to navigation with complete thoroughness as permitted by the circumstances.

The term “specifically charged” means that the lookout has no other duties at that time that could prevent him from keeping a proper watch.

Of course the skipper must delagate the lookout duties to a seasoned crew member who can react to events quickly and communicate effectively with the captain with little notice.

As captain of your yacht you are responsible for the vessel and the crew. Choose an experienced individual as lookout and review the navigation rules with this person so he can make the right call quickly as situations develop.

WHISTLE SIGNALS

- ONE LONG BLAST:** Warning signal
(Coming out of slip)
- ONE SHORT BLAST:** Pass on my port side
- TWO SHORT BLASTS:** Pass on my starboard side
- THREE SHORT BLASTS:** Engine(s) in reverse
- FOUR OR MORE BLASTS:** Danger signal

BRIDGE SIGNALS

		DAY (Flag)	NIGHT (Lights)
SOUND	VISUAL		
VESSEL: Open	VESSEL: Open	↑	↑
BRIDGE: OK	BRIDGE: OK	↓	↓
No	No	Same	Same
VESSEL: Replies:			
RADIO: VHF CH. 13			



NAVIGATION RULES

The Navigation Rules set forth 3 types of crossing situations- crossing, meeting, and overtaking. In each case, both boats are governed by special procedures.

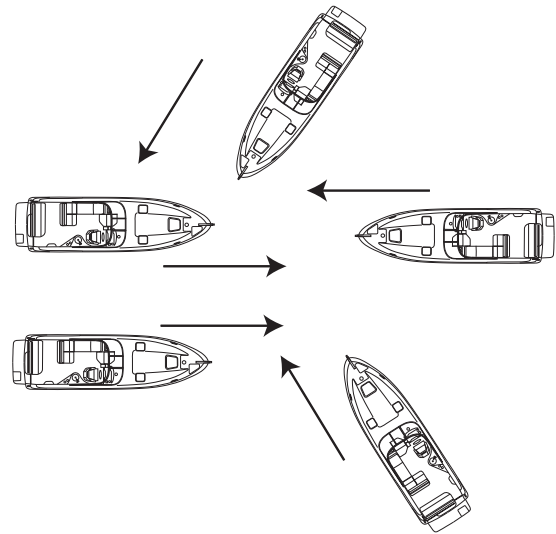

In a head-on meeting, both vessels must sound a single blast to give way toward starboard and pass to port.

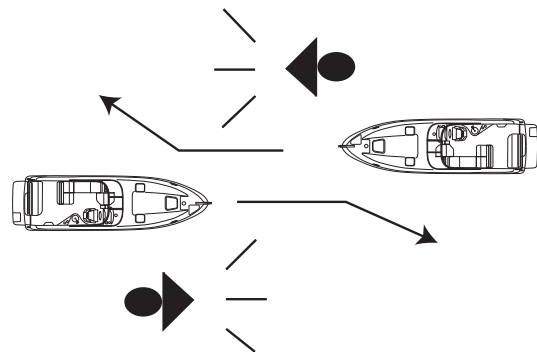

These rules appear when there is a risk of collision. In a crossing situation be aware of the other craft's position. For safety, there should be a noticeable change in the angle, bow or stern; a gradual change in position indicates possible danger.

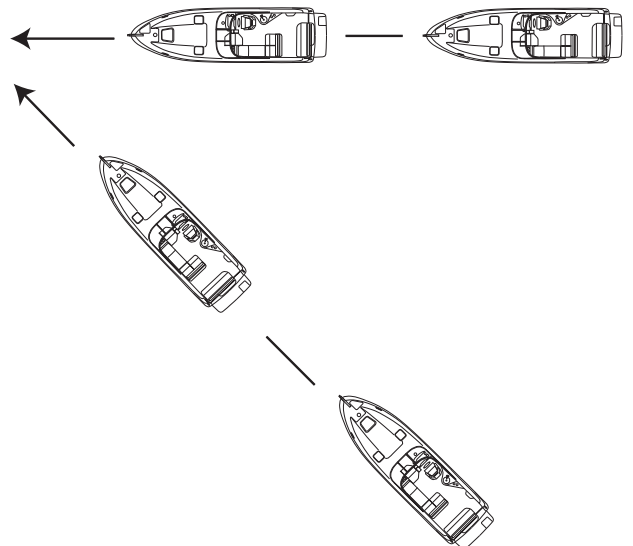



NAVIGATION RULES

An overtaking boat is burdened, and is not the privileged craft, even though it approaches the danger zone of the overtaken boat.

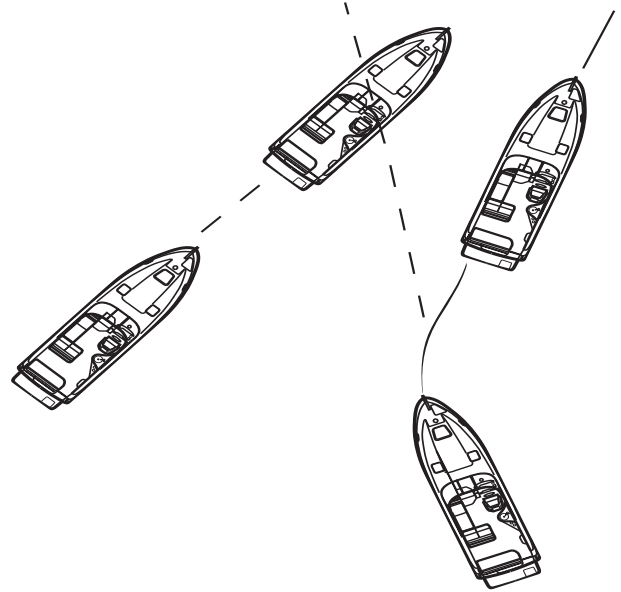

The overtaking boat first signals with a single blast if that boat desires to pass on the starboard side of the boat ahead, or a double blast if passing to port. The overtaken craft responds with the same signal if safe, or with the danger signal (5 short blasts or more) if unsafe. The boat overtaking must not pass unless the appropriate signals are sounded.

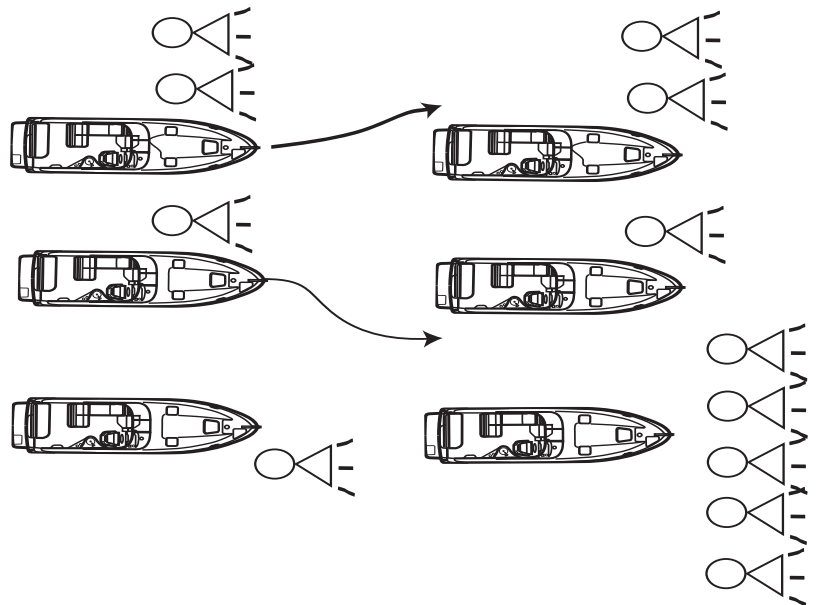



Rules Of The Road

NAVIGATION AIDS

Navigation aids are placed along coasts and navigable waters as a guide for mariners in determining their position in reference to land and hidden danger. Each aid provides specific information. They form a continuous system of charted markers for monitoring on the plotter or providing accurate piloting on paper as a backup.

Your on board plotter provides up to date navigation aids. Besides coastal maps a complete domestic interior waterway grid is featured on the plotter.

If desired, there are hand-held GPS devices that are available as back-up devices. In addition, nautical charts are provided by the National Ocean Service (NOS) and are distributed nationwide through marinas and outlet stores. These charts show the geography of the coast, water depth, landmarks, navigation aids (buoys and markers), marine hazards, and port facilities. Use only up-to-date charts for navigation. We recommend when purchasing a chart to look for the weather resistant ones. Buoys provide a roadmap to keep the skipper on course and to avoid hazards. Buoys are identified by light, shape, color and in severe weather conditions by sound.

Buoys or beacons called lateral markers indicate the port and starboard sides of the waterway to be followed. U. S markers follow the buoyage system known as Red Right Returning. When returning from sea or traveling upstream, the green markers are to port (on your left) and the red markers are to the starboard side (on your right). When traveling downstream or out to sea the marker color would be reversed.

Before operating your vessel, learn to identify the various navigational aids such as lateral aids, mid-channel markers, information and regulatory markers.

NOTICE

SKIPPERS MUST NOT RELY ON BUOYS ALONE TO MARK THEIR POSITION. SEVERE WEATHER CONDITIONS AND WAVE ACTION CAN ALTER A BUOYS POSITION. NEVER TIE UP TO A BUOY. IT IS ILLEGAL AND DANGEROUS.



LATERAL AIDS

Port Side
Odd Numbers

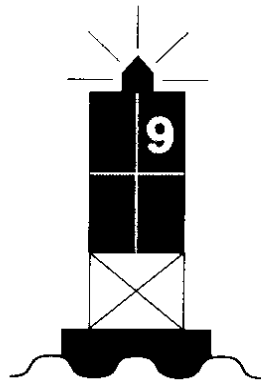

Lighted Buoy
(Green Light Only)

Chart Symbol



G "9"
Fl G 4 sec

Starboard Side
Even Numbers

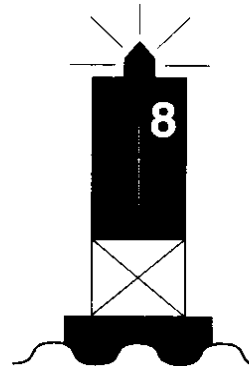

Lighted Buoy
(Red Light Only)

Chart Symbol



R "8"
Fl R 4 sec

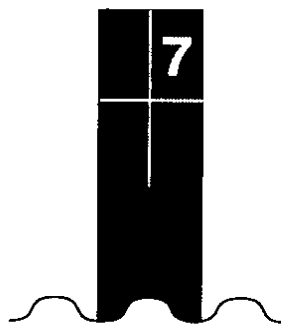

Can Buoy
(Unlighted)

Chart Symbol



C "7"

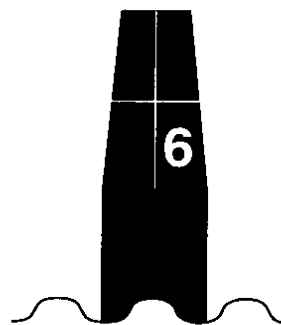

Nun Buoy
(Unlighted)

Chart Symbol



N "6"



Daymark

Chart Symbol



G "1"

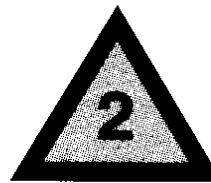

Daymark

Chart Symbol



R "2"



Rules Of The Road

MID-CHANNEL MARKERS

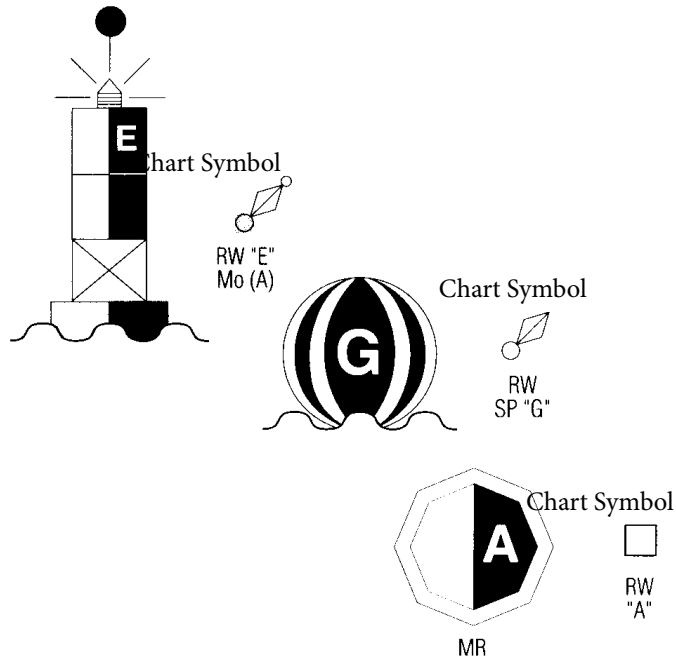

REGULATORY MARKERS

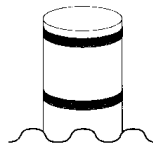

Diamond Shape Warns Of Danger



Diamond Shape With Cross-Boats Keep Out



Circle Marks Area Controlled As Indicated



For showing information such as locations, distances and directions



NIGHT RUNNING

Boats operating between sunset and sunrise (hours vary by state), or in conditions of reduced visibility, must use navigation lights. Night time operation, especially during bad weather and fog, can be dangerous. All Rules of the Road apply at night, but it is best to slow down and stay clear of all boats regardless of who has the right-of-way. To see more easily at night, avoid bright lights when possible. Also, it is helpful to have a passenger (appoint as lookout) keep watch for other boats, water hazards and navigational aids.

To determine the size, speed and direction of other vessels at night, you should use the running lights. A green light indicates starboard side, and a red light indicates port side. Generally, if you see a green light, you have the right-of-way. If you see a red light, give way to the other vessel.

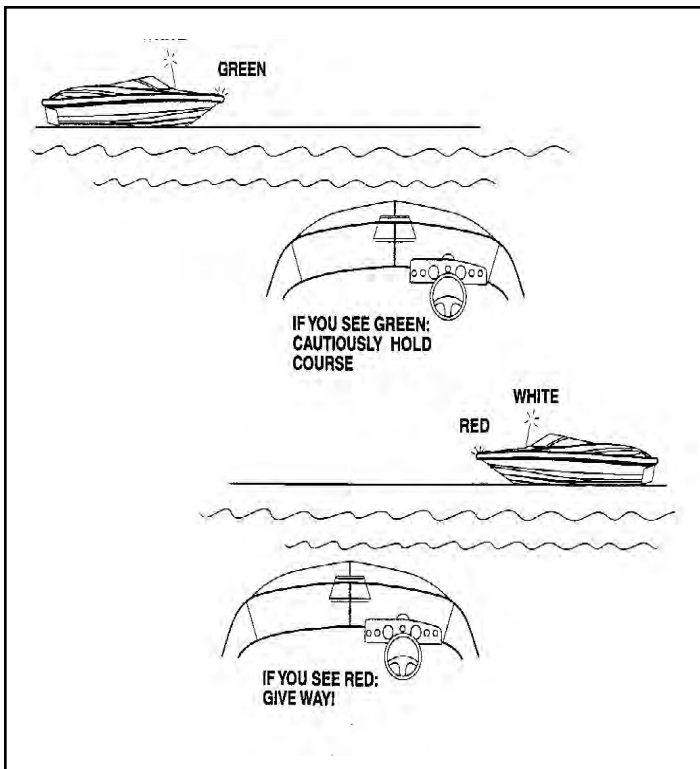

BRIDGE CLEARANCE



Be aware that your vessel requires a specified bridge clearance

height. This height is a measured estimate from the waterline to the top of the highest equipment height. The estimated height can change because of variances in the loaded condition of the vessel and equipment variances. Consult the bridge clearance specifications located in Chapter 12 (Technical Information section).

Some bridges are tendered. Know and use the proper bridge signals when approaching these bridges (see bridge signals in this chapter). You can also monitor and communicate on channel 13 of a VHF radio for bridge information in most domestic locals. Other bridges are marked with a clearance measurement and you are on your own. It is recommended that you have a look out posted for additional visual assistance when entering a bridge zone.

After determining your vessel will clear the bridge proceed with caution at a safe idle speed. Keep your eye on vessel traffic at all times in order to react quickly. Keep both hands on the helm since you may need to change course because of current and wind conditions. Resume a safe speed once clear of the bridge structure.

BRIDGE LIGHTING

Bridge lighting is maintained by the Department of Homeland Security. On the following pages are 2 typical examples of night-time bridge lighting. As the skipper approaches bascule and fixed bridges light position (arc of visibility) and color will indicate the safe channel through the bridge. Notice green denotes the “safe” entry location on single-span bridges and green or white on multiple-span bridges designates the main channel. In addition, green denotes the “up” position for single and double lift bridges.



Rules Of The Road

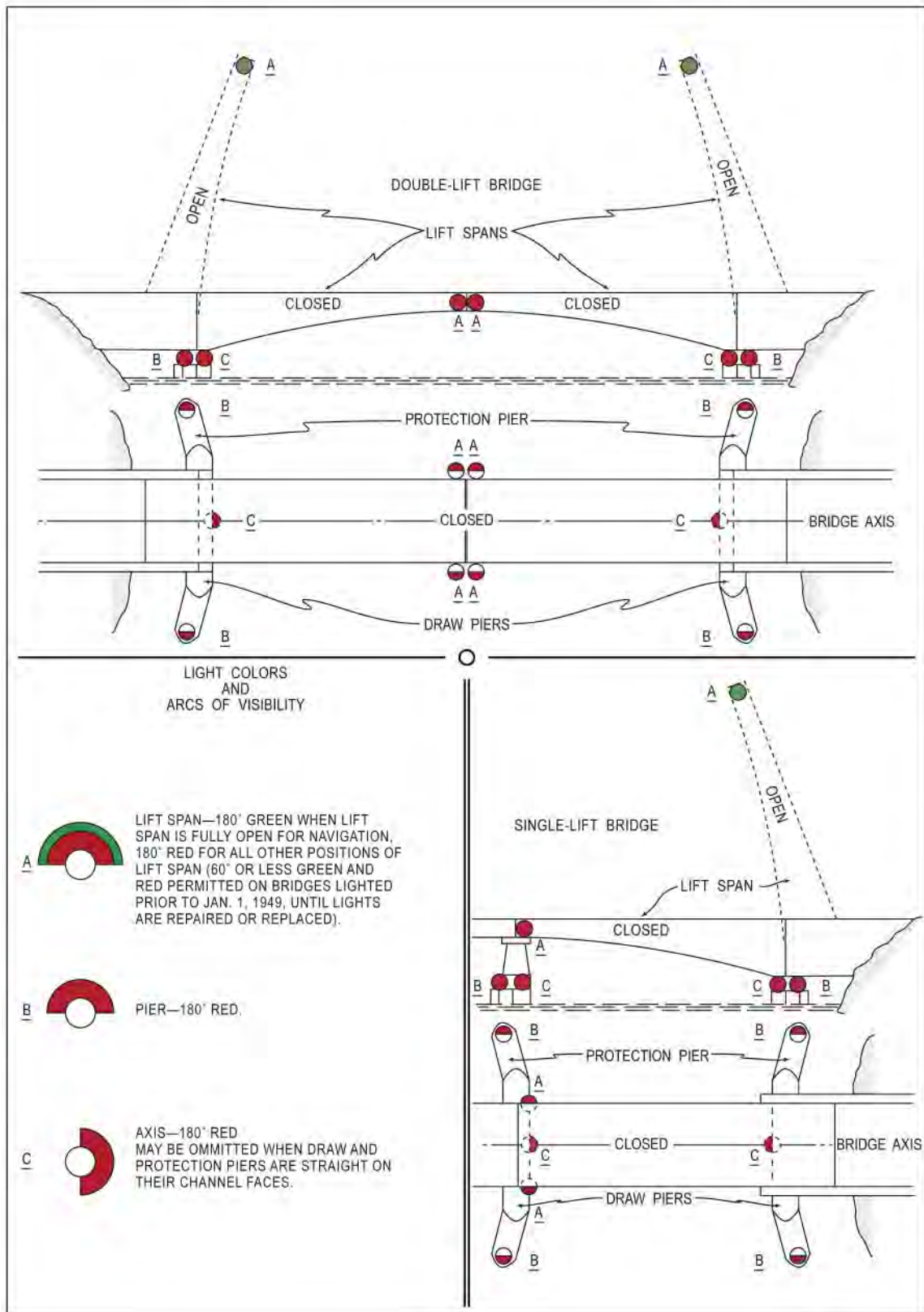

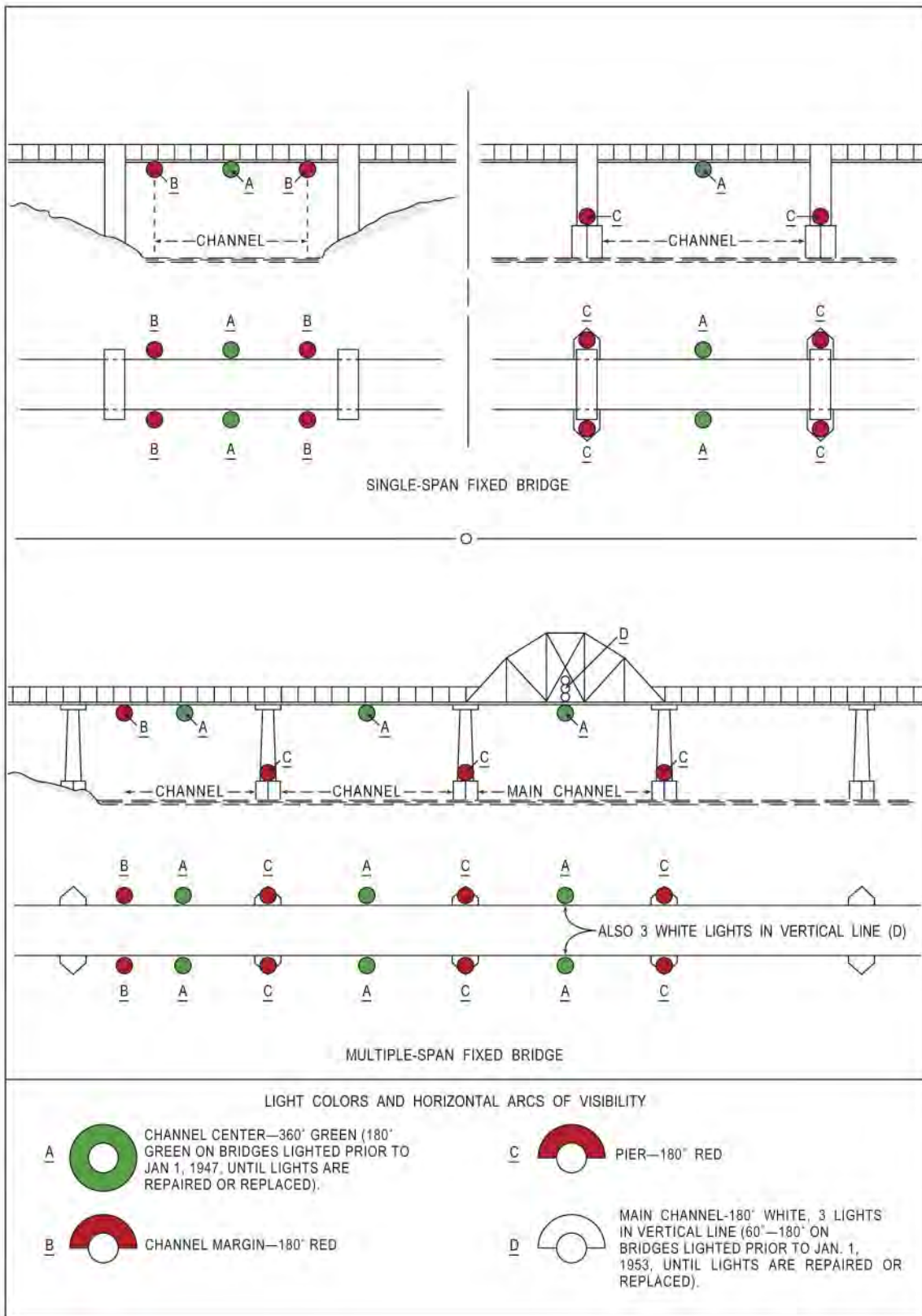



Systems



OVERVIEW

In this chapter the Regal yacht on board systems are introduced. Information includes several main systems including fuel, electrical, air conditioning (AC), windlass, water, waste, electronics, entertainment and trim tabs. This is the “meat and potato” section for main systems operation.

A system description, location of components, operational information along with common problems and solutions are covered with each of the system components.

Be sure to read and follow any danger, warning, or caution labels in reference to the yacht's systems or individual equipment components.

Your Regal yacht may not contain all of the equipment or systems shown. Regal has the right to modify, update or delete equipment and/or systems at anytime.

Refer to the vendor documentation located in the owner's information packet for more detailed information of individual yacht system components.



FUEL SYSTEM INTRODUCTION

In this section, the basic diesel fuel system components are introduced. The fuel system includes the fuel tank, fuel supply and return lines, fill and vent fittings along with fuel filters and the ventilation system.

Diesel fuel today is processed in a different manner than it was a few years ago. As a result it has become more unstable and the product shelf life has been shortened. A summary of so called diesel fuel “algae” along with its causes and effects will be outlined in this chapter.

As part of the Volvo product features the engines, EVC system and the transmissions are all protected by a fault handling system should a malfunction develop. A portion of this fault system is used to monitor the diesel fuel system.

Select codes warn the captain with a “buzzer” sound while others will display on the helm tachometer, display, or alarm panel. The “pop-up” will alternate between the cause of the fault and a task to perform to aid in eliminating the situation.

It is important to read and understand your Volvo propulsion owner’s manual in order to react to a fault code should a malfunction display on the instrumentation or an alarm sound.



WARNING

PREVENT INJURY, DEATH,
OR PROPERTY DAMAGE!
READ AND UNDERSTAND
THE PROPULSION OWNER’S MANUAL
BEFORE ATTEMPTING
TO OPERATE THE VESSEL.



DIESEL FUEL BASICS

Diesel fuel properties have changed in recent years due to the way the product is processed today at the refineries. A couple of decades ago diesel fuel, gasoline, home heating oil among other distillation products were processed by heating the crude oil. At different boiling temperatures, various parts of the crude oil were evaporated then condensed sending the final products to storage tanks for distribution. The distillation process generally produced stable diesel fuel with a storage life of several months. Around 50% of the oil left over from the distillation process was designated as heavy fuel oil being used for ship's, power plants, and industrial products such as nylon, plastics, and asphalt.

Refining crude oil today has changed dramatically due to increased demand for the product. A process called "chemical cracking" has allowed the refiner to extract more of the lighter distillates from the crude oil leaving about 16% of the residual as heavy fuel oils. Lowering the diesel fuel sulphur levels due to environmental concerns has led to further fuel instability. Due to these newer methods of refining diesel fuel is far less stable than the older distillation process.

There are different theorems on defining fuel system "algae" and how it develops in the vessel's fuel tank. Algae is slang for the fungus that grows in fuel tanks.

One school of thought isolates two of the key fuel components. Asphaltites and paraffins in this premise begin to oxidize and re-polymerize forming clusters resulting in fuel tank "algae". As these clusters "grow" in size they cling themselves to tank walls and baffles.

Others state that "algae" is formed when water condenses in the boat's fuel tank. Water can enter the vessel's fuel tank through the fuel pumping process at the fuel dock since their tank may already be contaminated with algae-micro organisms. Once inside the tank these algae-microscopic organisms from the plant kingdom are able to combine with water and diesel to form tank sludge.

Keeping tanks free from water, dirt and micro organisms is almost impossible, but luckily you can eliminate them before they reach the engine and fuel injectors through the use of primary and secondary fuel filters. Algae ends up in the fuel system once the boat is running which breaks up the tank "algae" and/or sludge into mini clusters.

When this condition is present in the marine diesel fuel system the fuel does not combust rapidly as it should resulting in a loss of engine efficiency.

Basically, with either school of thought this "algae" or fuel tank sludge is the result of aging diesel fuel. It can occur in as little as 60-90 days depending on the condition of the tanks and environment where the diesel fuel is stored.

Using diesel fuel in this condition may cause the following:

- Fuel tank sludge-remove manually or by chemicals
- Dirty engine oil
- Shortened engine component life
- Smoke emitting from the engine exhaust system
- Carbon deposits in the engine
- Incomplete combustion
- Loss of power and performance
- Clogged primary and secondary fuel filters
- Malfunctioning fuel injectors



SOLUTIONS FOR RECOVERING DIESEL FUEL QUALITY

As a Regal yacht owner you have a huge investment in your diesel propulsion system. Being the engines are a key component in the system, keeping the fuel system clean is a high priority.

Following are some solutions to help clean up a diesel fuel “algae” problem:

Periodically use a biocide to control microbial activity which can lead to more rapid formation or clustering of solids such as wax and asphalt. Remember that biocides do not prevent microbes from forming but aid in breaking up the clusters. If the vessel is to be stored for over 2 months pour biocide in the semi empty vessel fuel tank. Fill the fuel tank with fresh diesel fuel to prevent condensation build up. Run the boat for a short run to better mix the biocide inside the fuel tank and fuel system before storing the vessel.

1. Always make sure the fuel tank fill cap is securely tightened to prevent any water infusion.
2. Always buy diesel fuel from a marina or fuel dock that moves a large amount of fuel through the pumps. Ask how often the fuel dock pump filters are changed and if their diesel fuel is blended with a biocide. Always carry a couple of extra primary and secondary diesel fuel filters. Use exact replacements in order to match micron filtering capacity.
3. Figure on changing both primary and secondary fuel system filters more often due to today’s diesel fuel shorter storage life.
4. Make sure to drain the 10 micron Racor water separator fuel filter and the engine secondary fuel filter before each outing. Look for sludge/water. Dispose of contaminated diesel fuel properly in approved containers. Do not drain diesel fuel in the bilge.
5. Never let diesel fuel remain in the boat’s fuel tank for more than six months. The cetane value will drop which is its ability to ignite easily. Good grades of diesel support a cetane rating around 50. When the cetane level drops the engine is more difficult to start. The combustion process moves from a controlled burn to an explosion. Pump out the old diesel and replace with a fresh supply.

Old diesel fuel creates more stress on engine parts and produces more noise than normal resulting in the trademark diesel clatter.

Pour a cetane booster and conditioner in the fuel tank with the new batch of diesel fuel.

Note: In severe cases of “algae” the fuel tank may need to be pumped out. To remove the ability to generate new algae, the tank should be pressure washed which removes small deposits of “algae” from the baffle system and hard to reach areas. Add a biocide (not a conditioner) and then top off the tank.

Remember: LESS AIR MEANS LESS WATER AND LESS GROWTH!



TYPICAL VENTILATION SYSTEM

Diesel engines require a continuous supply of fresh air in order to generate peak horsepower and rpm. Because diesel fuel is far less likely to explode it does not require a blower system like gasoline powered vessels to evacuate dangerous fumes.

To deliver fresh air for the diesel engines a dual set of permanently mounted vents are integrated into the boat's deck on both port and starboard sides.

When the engines are started fresh air is drawn through the vent system. As the demand for air increases in relationship to the engine revolutions per minute (rpm's) the engine induction system supplies the required additional air supply by inhaling more air through the vents. Check the vents periodically for any obstructions or foreign objects such as nests or spider webs.

NOTE: If the propulsion system is running at a lower than normal cruising rpm or seems to lack power or the vessel is slow to plane check the fresh air supply to the engines including the engine air filters and ventilation system.

Note: Never make changes to a natural or powered ventilation system or obstruct intakes.

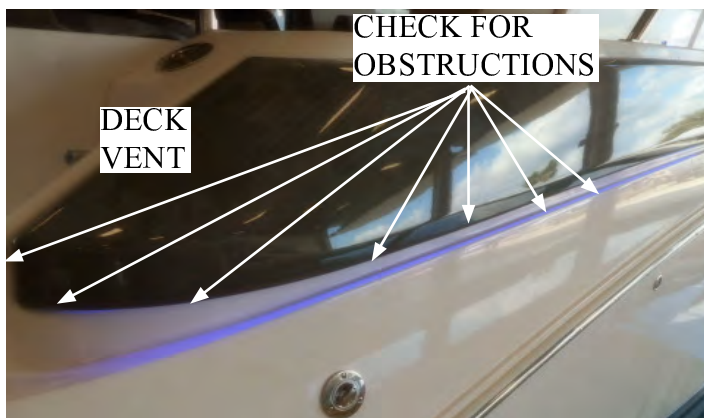



TYPICAL DIESEL FUEL SYSTEM

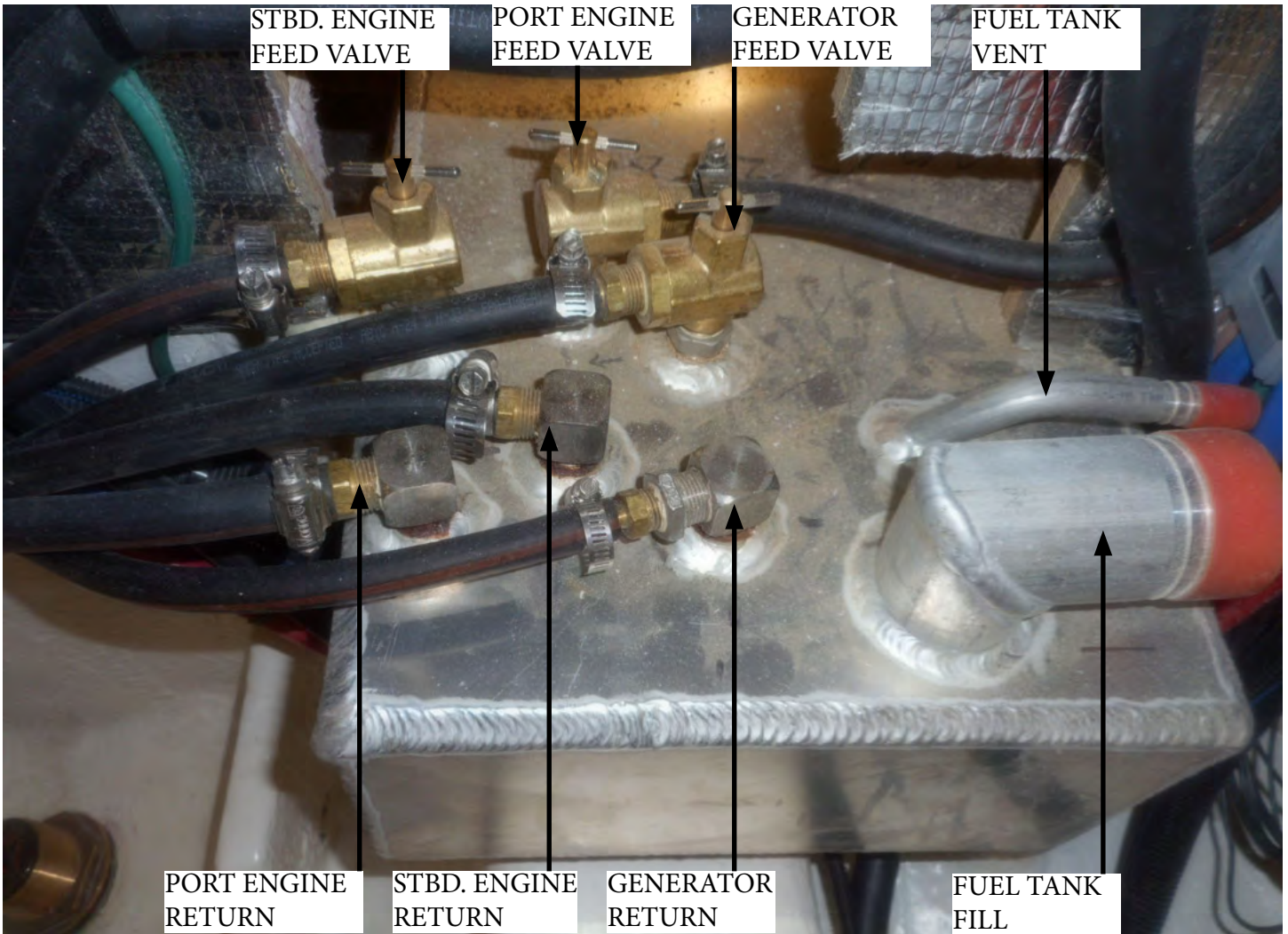

FUEL TANKS

The fuel tank is located under the aft stateroom floor. The fuel tank features shut-off valves for both engines and generator lines. Note that the feed lines feature shut-off valves. The fuel tank connections are located at the starboard engine fire wall bulkhead for friendly inspection and service. Besides the feed side of the diesel fuel system is a set of return valves and hoses. Left over fuel returns to the fuel tank for future use. Check entire fuel system for tightness and leaks at least twice yearly.

Knowing the basic fuel flow pattern may be helpful as a troubleshooting tool. In the event of a fuel leak the valves can be turned to the “off” position. Read and understand the fuel system warning below!

WARNING

PREVENT INJURY, DEATH, AND/ OR
PROPERTY DAMAGE!
INSPECT THE FUEL SYSTEM
AT LEAST TWICE ANNUALLY FOR LEAKS,
LOOSE CLAMPS, & FASTENERS.



TYPICAL FUEL SENDER

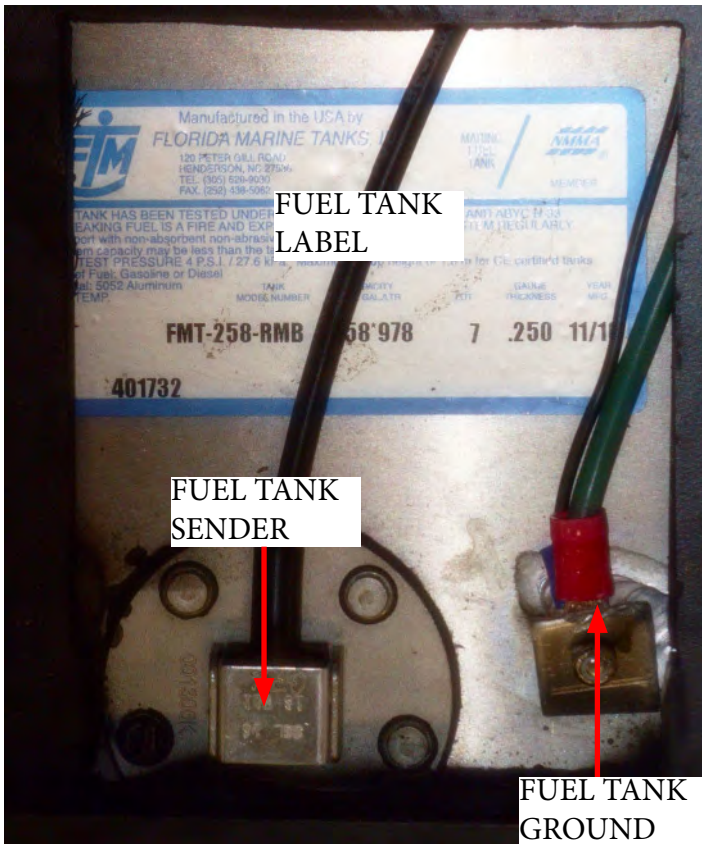

Placed at the top of the fuel tank is an electronic fuel sender. This device reads the amount of fuel remaining in the fuel tank and sends a signal to various displays including the fuel system display on the Garmin chart plotter(s)..

Always use the one-third rule with diesel fuel. One-third for outbound cruising, one-third for inbound cruising, and the remaining one-third fuel supply for reserve.

Note the green ground terminal and the fuel tank label. Check the ground terminal at least twice yearly for tightness since a loose connection could result in erratic or no fuel reading.

TYPICAL FUEL TANK FILL/VENT

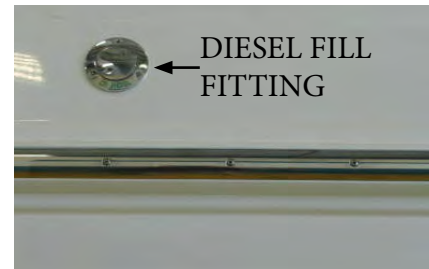

Fuel tank fill fittings are normally located on the deck. They are marked diesel. Never pump gasoline in a fuel tank designated for diesel fuel. After

fueling close the fitting tightly. Failure to secure the fuel fitting tightly may allow water to enter the fuel tank and eventually the engine fuel system. Periodically lubricate the fuel fitting O-ring by coating with clean diesel fuel. This will help keep the O-ring pliable and retain its sealing properties.

The fuel vent serves as a pressure relief for the diesel tank and is a safety overflow device. The vent is found below the fuel fill fitting at the starboard hull side. It has a screen inside which needs to be periodically cleaned. Insects can cause the vent to clog resulting in increased pressure in the fuel system especially noticeable when filling the fuel tank. In extreme clogging cases the fuel will emerge from the fill because the vent is not able to relieve the air in the fuel tank that is being replaced with diesel fuel.



TYPICAL DIESEL FUEL SYSTEM FILTERS

Regal yachts feature a primary and secondary fuel filter system to provide maximum engine protection. Both engines offer an in-line 10 micron Racor water separator filter which is the first line of defense. In addition, Volvo provides a secondary filter mounted on the engine for enhanced protection from water, dirt and “algae” micro organisms/clusters.

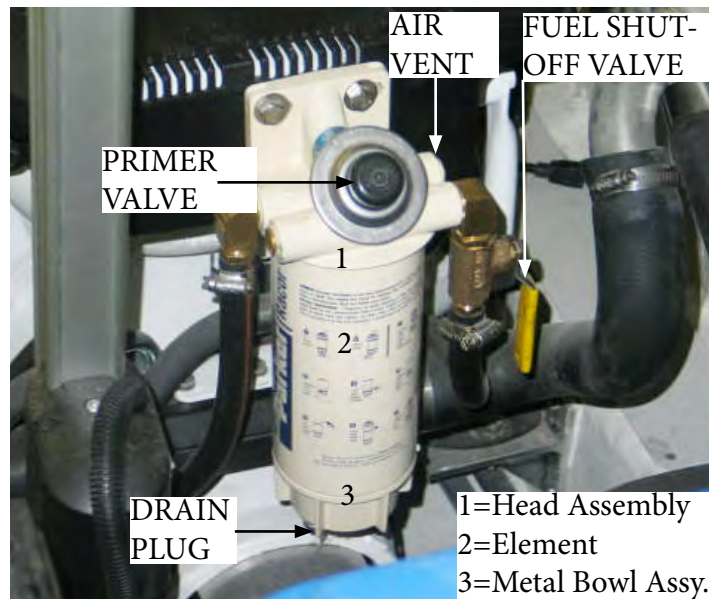

RACOR WATER SEPARATOR DIESEL FILTER

Examine the diesel fuel in the drain container. Water is heavier than diesel fuel and will be noticed as a different color on the bottom. If water is present tilt the pan and any water will move on the bottom. In extremely humid conditions, the fuel system may require daily checks and draining of water.

ALWAYS CARRY EXTRA FUEL FILTERS AS EVEN ONE TANK OF CONTAMINATED FUEL CAN PLUG A FUEL FILTER. USE EXACT REPLACEMENTS ONLY.

To Prime Racor Water Separator Filter

1. Loosen the air vent plug on the top right side of the fuel filter.
2. Operate the primer valve until diesel fuel emerges from the air vent plug free of air. In some cases, multiple pumping is required depending on the amount of air in the fuel system. Also, it is a good idea to prime the engine secondary filter as air could be trapped in the lines.
3. Close the air vent plug and tighten securely.
4. Start the engine and check for leaks. If the engine is difficult to start or is rough running check to see that all connections are tight and there are no kinked fuel lines.

To Drain Racor Water Separator Filter

The Racor diesel fuel filter should be drained frequently and checked for water and other contaminants as needed:

1. Place filter fuel valve in the “off” position which is perpendicular (90) degrees to the fuel lines. Failure to turn valve off may allow a continuous flow of fuel due to siphoning.
2. Place a suitable container below the filter bowl assembly to catch the contaminants.
3. Remove drain plug at the bottom of the filter bowl assembly. Drain the contaminants. Replace the drain plug.
4. Replace the drain plug. See section on “priming.



To Replace Racor Water Separator Filter Element

1. Place a suitable container under the bowl to collect the contaminated material.
2. Turn off the fuel valve.
3. Spin the element and bowl off in a counterclockwise direction using the correct filter removal tool. You can purchase these at retail auto or marine outlets.
4. Remove the bowl from the element.
5. Clean the bowl O-ring gland and bowl sealing surface of dirt, debris or "algae".
6. Lubricate a new O-ring and the element seal with fresh diesel fuel.
7. Place the new element seal into the element top with the bevel side up and the new O-ring into the bowl gland.
8. Firmly hand tighten the bowl onto the element. Now attach both onto the head by hand. **DO NOT USE TOOLS TO TIGHTEN!**
9. Prime the fuel system. Refer to the previous information.
10. Start the engine and check for leaks.

Notes-Element Replacement

Contamination level varies in fuels. As the fuel system slowly plugs the element fuel flow to the engine becomes increasingly restricted.

Replace the element every 500 hours, annually, or at the first sign of power loss or hard starting which ever comes first.

Secondary Engine Mounted Diesel Fuel Filter

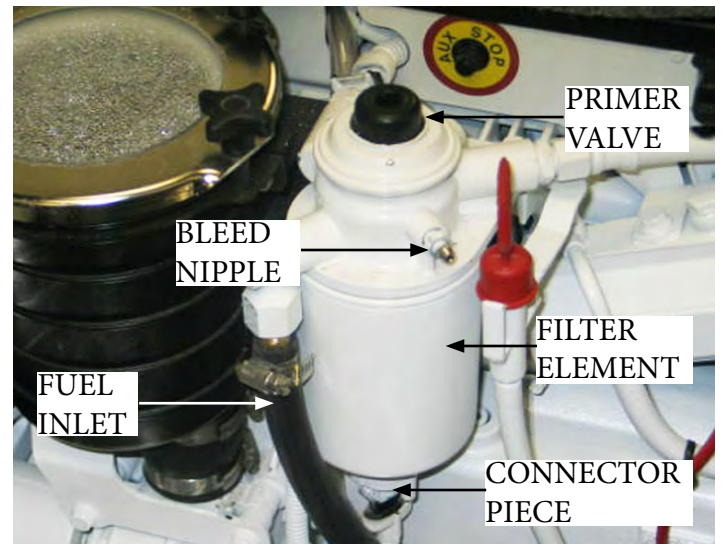

To Drain, Prime Or Replace Secondary Fuel Filter Element

Refer to the Volvo Penta IPS operator manual for specific information. Read and understand the procedures before attempting to service the secondary engine mounted fuel filter. Follow all safety requirements and environmental regulations when servicing the fuel system.



POSSIBLE FUEL PROBLEMS/SOLUTIONS



1. Engines are hard to start or rough running- This problem can be caused by air in the fuel system or a restriction in the fuel supply which causes a lean condition.

Check all fuel system lines, clamps, fittings and filters for tightness. Prime and bleed the fuel filters if necessary.

2. Fuel filter elements contain “algae” or exhibit a brown or black color and/or show water in the fuel system.

Check fuel tank for “algae” clusters. Fuel tank may require pumping out and a cleaning with a pressure washer or a biocide being added to “kill” existing organisms which may be caused by water in the fuel system and fuel tank. Replace all filter elements and top the tank with fresh diesel fuel. Prime and bleed the system. Run the engines and check for fuel leaks and restrictions along with the possibility of further contamination moving within the fuel system lines and/or components. It may be necessary to replace diesel fuel system filter elements several times to rid the system of contaminants.

3. The fuel tank reads low and the engines are running rough. The pick-up tubes in the diesel fuel tank have sucked up air instead of fuel. The air has meandered through the fuel lines, filters and is effecting the engine performance. Top off the fuel tank as soon as possible. Also, the fuel system must be bled and primed.

Another possible result of running with a near empty fuel tank is the same pick-up tubes sucking water into the fuel system. Remember water is heavier than diesel fuel and will hug the tank bottom or baffle areas. Take a sampling of diesel fuel to identify water in the fuel system.

4. Recommissioning after 6 months of winter storage with a full diesel fuel tank the engines are hard to start and exhibit a diesel clatter noise.

The diesel fuel in the tank may have deteriorated due to its age. The cetane value may have decreased causing more of an explosion inside the cylinder verses a controlled burn. To start with add a cetane booster and conditioner. If this fails take a sampling of diesel system fuel at the filters.

The diesel fuel in the tank may have deteriorated due to its age. The cetane value might of decreased causing more of an explosion inside the cylinder verses a controlled burn. To start with add a cetane booster and conditioner. If this fails take a sampling of diesel system fuel at the filters to determine contamination levels.

As a last resort pump out the fuel tank and replace with fresh, clean diesel fuel.



ELECTRICAL INTRODUCTION

In this section, basic DC (direct current) and AC (alternating current) electrical systems are introduced. Each electrical component is reviewed along with its location and function within the Regal yacht electrical system.

For more complicated issues outside the scope of this manual contact your closet Regal yacht dealer. They have undergone extensive training on the Regal yacht systems. Be sure to read and follow any danger, warning, or caution labels in reference to the yacht's electrical system or individual equipment components.



WARNING

PREVENT SEVERE INJURY OR DEATH!
DISCONNECT
ALL ELECTRICAL POWER SOURCES
BEFORE ATTEMPTING
TO REPAIR OR REPLACE
ANY ELECTRICAL COMPONENT.



DIRECT CURRENT (12 VOLTS)

Your Regal yacht uses 12 volt DC electricity otherwise known as direct current. It is called DC because it flows only one way in a circuit. Specifically to name a few, helm gauges, batteries, battery cables, engine electrical components, engine wiring harnesses, dash switches, selected lighting, shower sump, bilge pumps, and vacuum toilets are all components using a 12 volt DC system.

In the DC system used in the United States the red wire is designated as the “hot” or conductor wire and the black wire is referred to as the ground wire. At times other current carrying wires are color coded such as blue to identify their use as a low voltage conductor. This is especially helpful in troubleshooting and adding additional equipment. Be sure to review the wiring schematics in the drawing section of the technical chapter.

Direct current is stored in the ship’s batteries and produced through the engine alternators while the engines are running or by the battery charger at dockside. The alternators charge the batteries by sending current through the main distribution panel relays, battery switches and harnesses to the appropriate battery. Normal DC voltage is between 12 and 15 volts. Lower or higher readings could indicate a charging malfunction or a weak battery.

The Volvo diesel engine alternators used on your yacht are internally self “excited” and produce DC current at idle.

Current specifications for alternator output is 115 amps. The IPS steering system needs additional operating current and this is one reason the alternator output is higher than conventional units.

The port cranking battery controls the windlass, port engine and generator.

The starboard cranking battery controls the starboard engine, forward bilge pump and high water alarm.

The house battery controls a variety of onboard equipment functions..

BATTERY (12 VOLTS) DESCRIPTION

On board direct current is stored in the ship’s “wet cell” batteries. There are 2 engine starting batteries (one for each engine) and a deep cycle “house” battery.

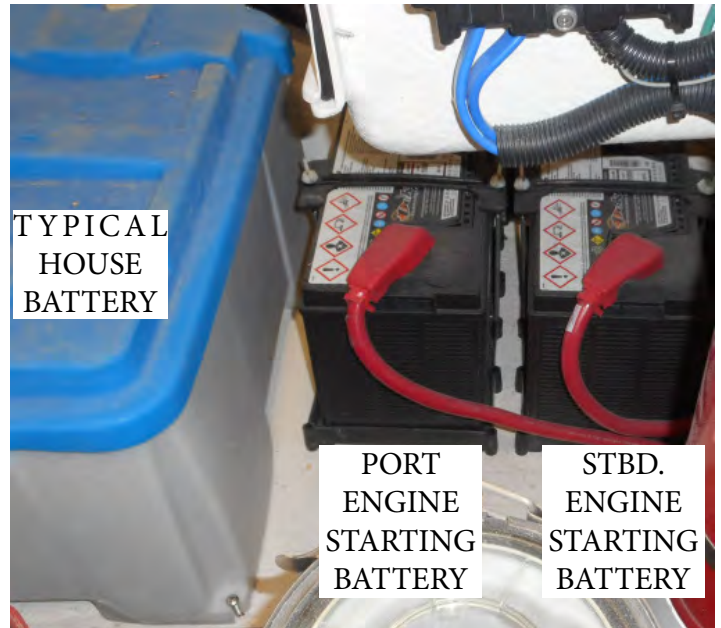

BATTERY SPECIFICATIONS			
Battery Type	Group	CCA @32 Degrees F.	Reserve Capacity
Engine Cranking	31A	1260	195 min.
House	8D	1700	430 min.



BATTERY TERMINOLOGY

Group- Batteries are divided into groups which identify the height, length, and width of the battery. This is useful information should a replacement battery become necessary.

Cold Cranking Amps (CCA)- This rating measures the cranking power a full charged marine battery has available to start at 32 degrees F. Basically, the higher the rating the greater starting power of the battery.

Reserve Capacity (RC)- As usage on the boat increases so does the need for more reserve capacity. The reserve capacity represents the length of time in minutes a new fully charged battery can maintain the yacht's electrical needs without the engine running or in the event the alternator fails.

POSSIBLE PROBLEMS/SOLUTIONS



1. Weak battery- This battery problem can be caused by low electrolyte cell levels. Warm, engine compartment temperatures will deteriorate a battery's life quicker by evaporating the water from the

electrolyte, thus corroding and weakening the positive grids inside the battery.

With the house battery low electrolyte levels can be monitored by periodic inspection and filling as needed with distilled water. Boaters in higher climate areas with longer stretches of hot weather will need to check their batteries more often.

The "maintenance free" engine cranking batteries require no water. They do feature a different chemistry that does consume less water. Inside the cells as gases are released condensation is formed which aids in maintaining the cell electrolyte level. These batteries incorporate a deeper layer of electrolyte over the plates, but eventually it can run dry. On the 31 series engine cranking batteries keep all terminals clean, connections tight and your electrical system in top shape to extend the battery life.

2. Dead Battery- Either the battery will not accept a charge, hold a charge or the charging system is not supplying a charging current through the battery charging system and/or engine alternators.

The battery charger output can be checked by monitoring the lights on the charger front face.

To begin with check the battery post connections for tightness and corrosion.

With the engines running the displayed voltage of the port or starboard engine battery and house battery should be between 12.5 up to 14.6 volts. If less than 12 volts check for voltage across the battery terminals.

If less than 12 volts on the house battery use a hydrometer to locate faulty cells.

On maintenance free batteries they can be removed from the vessel if necessary and trickle charged. If readings after charging are still low replace the battery.



REMOTE BATTERY SWITCH PANEL



PORT REMOTE BATTERY SWITCH

HOUSE REMOTE BATTERY SWITCH

STBD. REMOTE BATTERY SWITCH

As part of the battery management system 3 remote battery switches are located in the engine room.

A remote battery switch is wired between each engine and the “on-off” battery switches located under the starboard cockpit cushion. Their purpose is to break up the long battery cable runs and they offer a shorter run from each battery to the starter motor. In addition, the remote battery switch from the bilge (sump) provides an avenue to shut down the battery system during engine or sump routine maintenance functions.

If the remote battery system fails the skipper can turn on the remote battery switch manually through the manual override switch located on each remote battery switch which will generate power for engine starting.

Each remote battery switch provides a continuous rating of 300 amps DC and a cranking rating of 1250 amps DC. Remote battery switches are “in line” between each battery and the engine.



REMOTE BATTERY SWITCH OPERATION

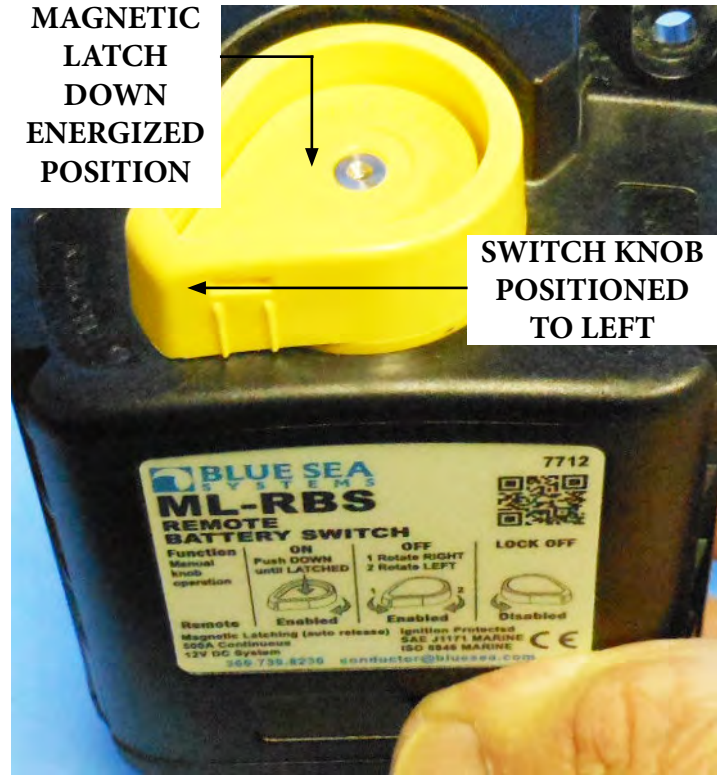
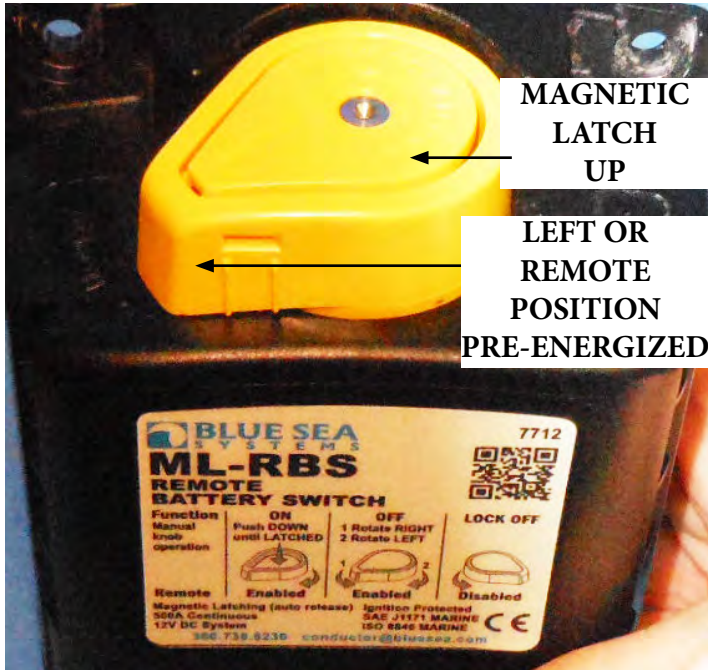

1. **Normal operation** of the remote battery switch is completely to the left in the auto or “remote” position. Notice latch position is up (manually disengaged). To energize one of the engine cranking circuits or the house circuit first flip on the battery switches at the battery activation panel located under the cockpit starboard seat. This will permit power to flow from the dash engine starting panel to the engine cranking circuits. Next, by passing the key fab over the dash engine panel the appropriate engine starting circuit is engaged.

Note that Normal engine starting will cause the magnetic latch to be pulled down in the energized position.

2. If the remote battery system fails for some reason the skipper can override the remote battery switch manually through the magnetic latch which is located on top of the switch. Just turn the switch to the left and push the magnetic latch down until it engages.

3. In the event of servicing the engines or house battery components simply turn the remote battery switch to the right (Lock or Off Position). Pass a tie wrap through hole to secure the remote battery switch knob until servicing is complete.



REMOTE BATTERY SWITCH OPERATION

Under normal conditions with the vessel charging system working properly each remote battery switch should show a lighted LED on the faceplate. When the remote battery switch is in the “OFF” position the LED is not lighted. The manual override switch should be located in the AUTO position. Read and understand the notice below.

NOTICE

IF THE REMOTE BATTERY SWITCH IS TURNED TO THE LOCK OR “OFF” POSITION THE ENGINE WILL NOT CRANK. TURN THE REMOTE BATTERY SWITCH TO THE REMOTE OR “ON” POSITION FOR ENGINE CRANKING POWER. NEVER TURN A REMOTE BATTERY SWITCH TO THE LOCK OFF POSITION WHEN A ENGINE IS RUNNING.



Note that when the battery switches are activated they will generate a light which alerts the skipper. Red for port cranking battery, blue for house battery, and green for starboard cranking battery.

When leaving the vessel it is recommended that the battery switches at the activation panel be turned off. Remember even with all switches off at the battery activation panel, certain safety functions such as bilge pump circuits still operate. See the following page for further information.,



With all 3 **battery activation panel switches** in the “off” position the following common breaker circuits are considered “on” and should show a lighted icon **next to the engine room battery management panel breaker name**. These are the common breakers that will be “on” when you normally leave the vessel for extended periods of time.

ALL 3 BATTERY SWITCHES “OFF”

1. Battery charger
2. Fwd. bilge pump
3. Aft bilge pump
4. High water alarm
5. Stereo memory
6. Shower pump

Other possible battery switch positions are:

“HOUSE” BATTERY SWITCH ONLY “ON”

1. All breakers “on” except for windlass and accessory

“PORT” BATTERY SWITCH ONLY

“ON”

1. Common breakers plus accessory and windlass

“STARBOARD” BATTERY SWITCH ONLY “ON”

1. Common breakers and cable reels. No additional breakers “on”.



POSSIBLE PROBLEMS/SOLUTIONS

Some of the more common problems with the remote-battery switch could be:



1. Engine will not crank over- The remote battery switch is in the “off” position. Reposition the remote battery selector switch to the “on” position.

2. Remote battery switch in “on” position but engine will not crank over. Make sure the universal battery switch on the battery management panel is “on” to provide power to the helm. Check the appropriate battery connections for corrosion and tightness. Check battery with volt meter as described earlier and a hydrometer if needed. If battery is determined to be weak press the battery parallel switch to crank the engine over or start the generator which will initiate charging of the weak battery.

TYPICAL RELAY FUNCTION

The previous management system drawing shows a relay (located inside battery management panel) wired between each remote battery switch and the appropriate battery switch under the cockpit starboard cushion. The purpose of the relay is to provide a complete circuit for the remote battery switch. When one of the battery switches is activated the remote battery switch circuit is closed allowing the appropriate engine to be started at the helm. The relay closes when the ON-OFF universal battery switch is energized in the cockpit..

In theory, the relay switches reside “on” the ground circuit of the electric battery switch not the “hot” side.

POSSIBLE PROBLEMS/SOLUTIONS



1. The engine does not crank over. Relay is defective causing an open ground circuit- Open the battery management panel and by-pass the relay by pulling the wire off the 87A relay terminal and touch it to the 87 terminal. Have someone crank the engine at this point (Stand clear of any moving engine parts). If the engine cranks contact your closest Regal yacht dealer for replacement parts.

2. The engine does not crank over. Check relay for corrosion or loose connection.



TYPICAL BREAKER

As part of the battery circuit protection from the battery to the battery management system panel a 150 amp breaker is installed within 40” of the battery. These breakers are located in the bilge.

If the breaker would draw excessive amperage it is possible it could “blow”. At this point it would need to be reset.

Always determine the reason why the breaker blew before resetting the breaker.

To reset the breaker move the lever from the “off” position to the “on” position as indicated by the red arrow above.

Before resetting the breaker, it is important to determine the reason why the breaker blew. To reset the breaker, move the lever from the “off” position to the “on” position as indicated by the red arrow above.





TYPICAL BATTERY CHARGER



The yacht battery charger features 50 amp output and universal voltage for 3 battery circuits. This means that the battery charger will operate from 95 volts through 277 volts either at 50 or 60 Hz. This is helpful on docks that carry lower voltage. The new electronic battery chargers are “smart”. They will charge the batteries in 3 stages; bulk, absorption, and float formats. The charger is

designated to get the maximum life out of your batteries, using micro computer controlled charging.

It is recommended to keep the battery charger “on” at all times when AC power is available for maximum battery life. We recommend checking the battery water level weekly.

The charger is factory set to charge flooded lead acid batteries which are the most common type available. The charger can be reprogrammed to take gel cell or AGM batteries.

In the event the boat is switched over to different battery designs, it is important that all batteries are changed over to the same type.

Remember, changing to a different battery type requires re-programming the charger. Do not mix different designed batteries because they need different charging rates and voltages.

During bulk charge the battery charger brings up the battery charge state quickly, as the battery nears fully charged, it switches over to absorption charge. Absorption charges at a lower rate than bulk, until the battery is just a few % away from full charge.

The battery charger display includes functional LED information for charge current, charge voltage, charge phase (bulk, absorption, float), battery content measurement and/or battery condition measurement as a % of Ah capacity.

It is recommended that an ABYC certified electrical technician perform any repairs or service. Do not attempt to open the battery charger casing.

Refer to the vendor information for more detailed instructions.



WARNING

PREVENT INJURY, DEATH, OR
PROPERTY DAMAGE FROM HIGH VOLTAGE!
DISCONNECT THE AC POWER SUPPLY
BEFORE ATTEMPTING TO BEGIN ANY
BATTERY CHARGER SERVICE WORK.



VSR (VOLTAGE SENSITIVE RELAY)



Located on the battery management panel are 2 VSR's (voltage sensitive relays). The purpose of the VSR is to protect the engine batteries from being discharged. Also, when the engine batteries are fully charged it sends current to charge the house battery.

When the cranking battery(ies) rise above 13.7 volts DC the VSR switches to charge (cranking and house) both batteries in parallel simultaneously. When the battery voltage drops to 12.8 volts DC the VSR disengages.

This VSR capability is referred to as "dual sense". This permits the VSR to sense the voltage of both batteries that it is connected between. If one of the batteries is receiving a charge the VSR will close by paralleling both battery banks to charge the house battery along with the 2 engine cranking batteries.

Notice the illustration shows a LED light which indicates when lite that the VSR is closed and is sending a charging current to a battery(ies).

If the VCR senses the engine batteries are being discharged at a fast rate it will open and will not allow those batteries to be overly discharged to the point that the engines will not crank over.

An example of the above situation would be if the vessel was stationary at sea for an extended period with various electronic and entertainment equipment energized along with the engines and generator off the batteries would normally discharge.

POSSIBLE PROBLEMS/SOLUTIONS (VSR)

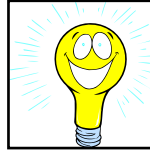

1. Red LED light not visible at VSR- One cause could be the remote battery switch is not energized.

2. Red LED light stays on after the engine is turned off- This is a normal condition. The residual battery voltage because of battery charging has not yet dropped below 12.8 volts for the VSR to cut out.



TYPICAL CHARGING SYSTEM- SUMMARY NOTES

Following is a summary regarding the yacht charging system or specific charging system components.

1. With the battery charger unplugged from shore power the battery charger is not generating any DC power. However, the battery charger is connected to the batteries through the battery switches and charger breakers which are located on the battery management panel. The charger breakers would stop any short in the wires that run directly to the battery charger. Remember that the charger is connected to the battery side of the switch and is continuously “hot”.

2. There is a breaker protecting the battery charger circuit. A primary cause of the breaker to “trip” would be if the positive and negative battery cables were crossed. The above situation could easily happen if someone was trying to jump start a battery with “jumper cables.” To a lesser degree should a wire delivering current from the battery charger chafe a fuse may “blow” and the battery charger would cease its charging operation. See your Regal dealer for ordering extra fuses for your charger.

2. If one of the cranking batteries is weak or “dead” first start the generator up and let it run awhile as it will send an initial charge to the weak battery. Then engage the battery parallel switch to start the engine.

3. Always turn the battery activation battery switches to the “off” position when leaving the vessel for extended periods. Select breakers that control specific safety functions of the boat will operate as normal.

4. The Bosch relay located inside the battery management panel is connected to the remote battery switch. It closes when the battery activation switch is energized. Remember the appropriate engine will not crank over with a battery activation switch in the “off” position.

5. An internal battery charger fuse protects the entire circuitry from reverse connections. For example, if someone was attempting to “jump” start an engine and had the polarity reversed on the jumper cables this action may cause the internal fuse to “blow” thus making the charger inoperative.

Bottom line- always remove a battery if using a trickle charger. It is not recommended to jump start using booster cables.



TYPICAL E-KEY FOB PANEL



Your vessel uses the Volvo E-key system. It features a dual E-key panel with ignition and start-stop switches along with a sensor to unlock the system when a key fob is swiped at the panel.

When the ignition lock is activated a red light flashes under the symbol. To **deactivate** the ignition lock swipe or hold the key fob in front of the (o) symbol in the lower center of the E-key panel. A sound will be emitted as the system becomes unlocked and the red light goes out. Once the ignition lock is deactivated pressing the ignition button will show a green light indicating that engine is ready to be started.

Note that the vessel includes 2 key fobs. Additional key fobs up to 4 can be added. Refer to the Volvo operator's manual.

 **WARNING**

AVOID POSSIBLE BODILY INJURY OR DEATH!
REMOVE KEY FOBs FROM THE IGNITION
PANEL VICINITY WHEN THE ENGINES
ARE NOT RUNNING.

E-KEY PANEL/ STARTING ENGINES

There must be an active station to start the twin diesel Volvo engines. Once the E-key panel is unlocked (deactivated), and the ignition is switched on the station becomes active. At this point the engines are ready to be started.

To start the engines, press the START/STOP button which will cause the starter circuit to start the engine. Once the engine starts press the remaining START/STOP button to start the other engine.

Note that if the starter motor engages for a full 30 seconds and the engine does not start it will disengage itself at that point to protect the starter motor from overheating. Leave the starter motor cool for 5 minutes before attempting to restart that particular engine.

Note to make sure the remote control is in the neutral position before starting the above starting process.



FLY BRIDGE START PANEL

See the fly bridge chapter regarding using the E-key system and starting the engines from the upper station.



BATTERY PARALLEL SWITCH



The battery parallel switch is connected through the engine ignition switches to each of the engine cranking batteries. If one of the engine cranking batteries is weak this system will use the good battery from the one engine to provide cranking power for the weak battery of the other engine.

It is always recommended to let the weak battery recharge awhile before using the battery parallel switch. This can be done by using dockside power or by running the generator. This process will supply some initial charging energy to the weak battery. It is even more important to follow the above procedure if the battery is “dead.”

The battery parallel switch is located next to the Volvo key fob panel at the main helm and at the bridge on Fly models. To activate the battery parallel switch first start the engine with the charged battery. Let the engine run for a few minutes. Now depress the battery parallel button while simultaneously cranking over the weaker battery's engine. After the engine starts release the button mechanism.

BATTERY MANAGEMENT SYSTEM

OVERVIEW

The battery management system is an important ingredient of the yacht's 12 volt direct current (DC) system. The battery management panel consists of 2 VSR's and 2 banks of DC breakers plus the wiring itself.

Refer to the battery management information chart in this section and the technical chapter for a breaker amperage listing. Be aware that in some cases the breaker protects a component; in other cases it may control a sub-panel or parts of a sub-panel.

The port VSR is connected to both the port cranking battery and the house battery. The starboard VSR is connected to the starboard cranking battery and the house battery.



TYPICAL BATTERY MANAGEMENT SYSTEM





TYPICAL BATTERY MANAGEMENT SYSTEM PANEL-COMPONENT BREAKER DESCRIPTION

PORT PANEL LEG

CABIN MAIN- protects the cabin main DC panel which controls direct current switch functions throughout the vessel.

ELECTRONICS- protects all electronic dash equipment components along with the stereo components. In addition, this breaker controls all breakers from the electronics switch through breaker panel located at the starboard helm seat locker.

DASH MAIN- protects dash operation switch functions, and engine hatch panel. Volvo engine functions are not controlled by the dash main breaker.

AMPLIFIER- protects the stereo system amplifiers that boost output and drive the stereo system speakers.

AFT BILGE PUMP- protects the aft bilge pump located in the engine room.

HIGH WATER ALARM- protects the bilge high water alarm. This audible alarm sounds at the dash should bilge water reaches a predetermined level. Normally this would indicate large volumes of water are entering the bilge since normal amounts would be drawn overboard via the bilge pump system.

HOSE/CABLE REEL- Protects the shore cord hose reel /washdown system.

HATCH LIFT- protects the aft engine hatch circuitry.

ACC (ACCESSORY)- protects any add-on equipment components. If adding components ensure that the amperage does not exceed the safe limits of the breaker.

STARBOARD PANEL LEG

WINDLASS- protects the deck mounted anchor windlass circuitry.

CHARGER- Each breaker protects one of 3 battery charger outputs.

FWD. BILGE PUMP- protects the forward most bilge pump.

SHOWER PUMP- protects the aft/forward shower sump pump circuitry.

STEREO MEMORY- protects the stereo system memory circuit and the stereo unit itself.

OIL CHANGER- protects the engine and generator oil changer pump circuitry located in the bilge.

POWER PLATFORM- protects the optional swim platform dingy launch system circuitry.



NOTICE

AS A SAFETY FEATURE
THE FORWARD AND AFT BILGE PUMP
CIRCUITS ALONG WITH THE HIGH WATER
ALARM ARE CONTINUOUSLY “ON” EVEN
WITH THE BATTERY SWITCHES IN THE OFF
POSITION.



WARNING

PREVENT POSSIBLE FIRE/EQUIPMENT
DAMAGE!
NEVER TURN THE BATTERY SWITCHES TO
THE “OFF” POSITION WHILE THE ENGINES
ARE RUNNING.

Note: As stated above the 115 amp diesel engine alternators or electronics may be damaged from the current spike created by turning off a universal battery switch with the engine running.



POSSIBLE PROBLEMS/SOLUTIONS



1. It is possible that one of the battery management system breakers may trip from long-term arcing and heat. The breaker may need to be reset- This might happen occasionally with one of the battery charger breakers. To trip and reset

this style of breaker do the following:

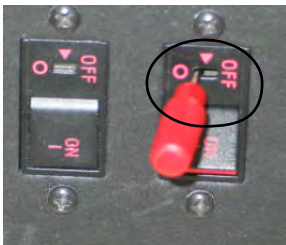

A. Take a small slotted screwdriver from your on-board tool kit and insert it in the breaker slot until it trips. You will hear a snapping type noise. See the illustration.

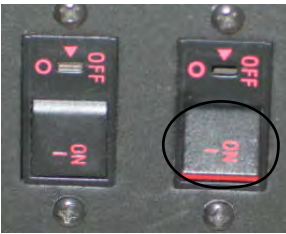

B. Notice that the breaker has pushed outward from its original flush position indicating the breaker has been tripped. See the illustration.

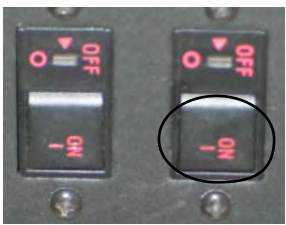

C. To reset the breaker use your finger to press the breaker down until it locks in the “on” position. You may hear a slight noise. This is normal. The icon light should be lighted after this procedure.

See the illustration.

2. Breaker will not reset- Replace the breaker. Contact the nearest Regal yacht dealer for replacement parts.

3. Breaker continues to “trip”. Check the affected equipment to determine if it is responsible for the excessive draw to trip the breaker. If the equipment is determined to be within specifications check for a “short” in the wiring circuit. Also, the breaker may be faulty. Contact the nearest Regal yacht dealer.

Note: It is possible under certain circumstances that a breaker may preform a “soft” trip on a circuit. The breaker may not appear to be in the tripped position but at this point current to dedicated components is interrupted.

It is recommended to turn any equipment on the circuit to the “off” position until the breaker is reactivated. In this situation insert the screwdriver blade into the breaker slot until it fully trips the breaker. Then reset the breaker by pushing the breaker down until it clicks into place. At this point energize the circuit by activating components or equipment.



BATTERY MANAGEMENT PANEL WIRING SPECIFICATIONS							
COMPONENTS	BKR. SIZE	% VOLTAGE-DROP	W I R E GAUGE	W I R E COLOR	WIRE RUN LENGTH	POWER SOURCE	24 HOURS MONITORING OR SWITCHED
VSR RELAY PORT						PORT ENGINE BATTERY	24 HOURS
VSR RELAY STBD.						STBD. ENGINE BATTERY	24 HOURS
BREAKERS							
DASH MAIN	80	3	2	RED	50	HOUSE BATTERY BANK	SWITCHED
CABIN MAIN	80	3	2	RED	50	HOUSE BATTERY BANK	SWITCHED
WINDLASS	150	10	2	RED	85	PORT ENGINE BATTERY	SWITCHED
ELECTRONICS	90	3	2	RED	50	HOUSE BATTERY BANK	SWITCHED
POWER PLATFORM	60	10	6	RED	30	HOUSE BATTERY BANK	SWITCHED
HATCH LIFT	20	10	4	ORANGE/BLK.	50	HOUSE BATTERY BANK	SWITCHED
CHARGER	80	10	4	RED	40	CHARGER/PORT BATTERY	24 HOURS
CHARGER	80	10	4	RED	40	CHARGER/HOUSE BATTERY	24 HOURS
CHARGER	80	10	4	RED	40	CHARGER/STBD. BATTERY	24 HOURS
HOSE/CABLE REEL	20	10	10	RED	50	HOUSE BATTERY BANK	SWITCHED
OIL CHANGER	20	10	10	RED/VIOLET	60	HOUSE BATTERY BANK	SWITCHED
ACCESSORY	20	10	10	ORANGE/BLK	50	HOUSE BATTERY BANK	SWITCHED
AFT BILGE PUMP	10	10	14	BROWN/WHITE	40	STBD. ENGINE BATTERY	24 HOURS
MID BILGE PUMP	10	10	14	BROWN/BLUE	40	PORT ENGINE BATTERY	24 HOURS
FWD. BILGE PUMP	10	10	14	BROWN/RED	40	STBD. ENGINE BATTERY	24 HOURS
HIGH WATER ALARM	5	10	16	GREEN	20	PORT ENGINE BATTERY	24 HOURS
STEREO MEMORY	10	10	16	YELLOW/BLK.	50	HOUSE BATTERY BANK	24 HOURS
SHOWER PUMP	5	10	16	BROWN/BLACK	20	HOUSE BATTERY BANK	24 HOURS



TYPICAL MAIN DC PANEL METER/SWITCH FUNCTIONS

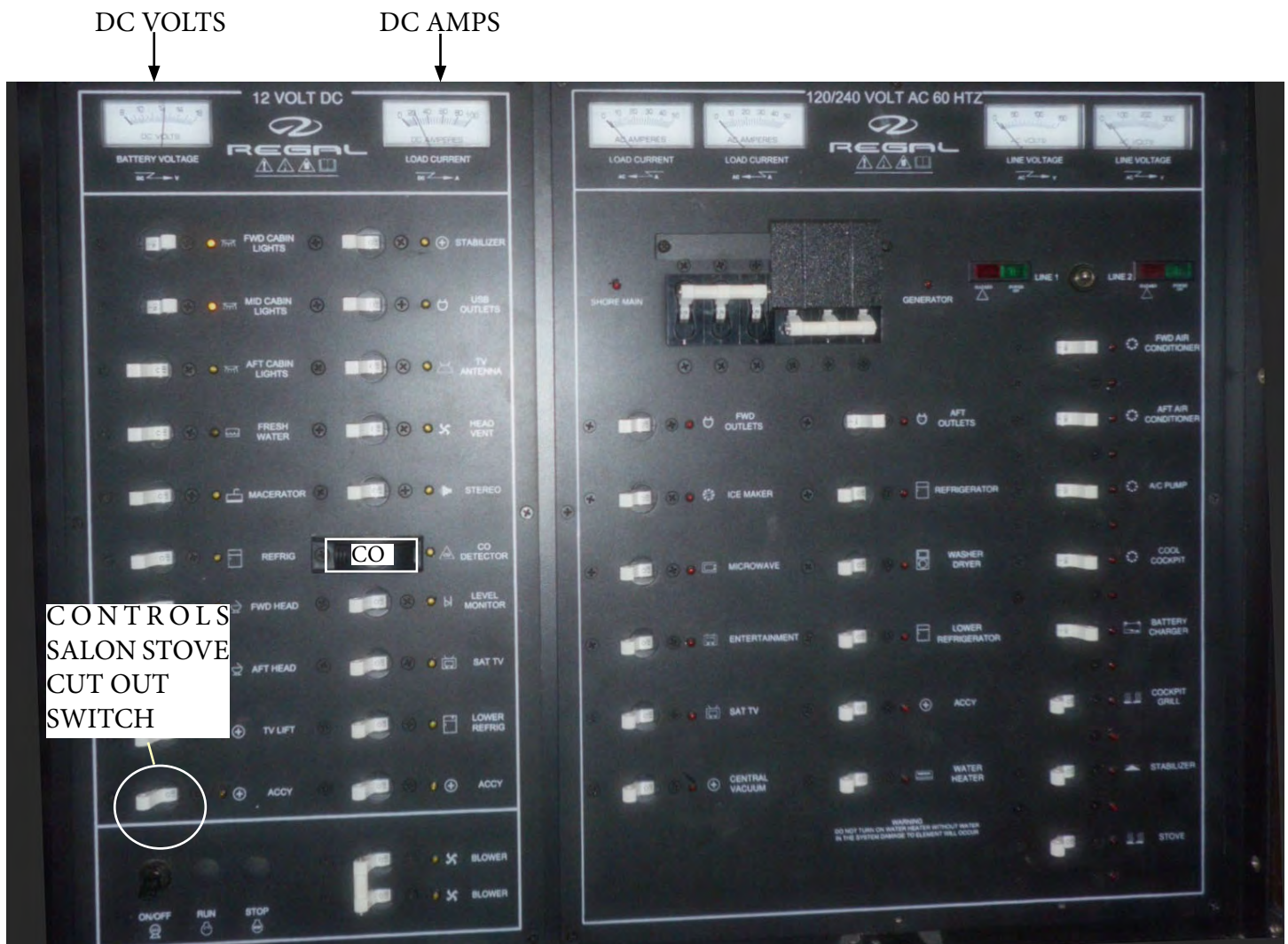

The main DC control panel is located near the salon stairway behind a set of cabinet doors. The port panel protects direct current circuits. The starboard panel protects AC circuits. This panel is protected by the cabin main breaker at the battery management center. The panel features an analog 12 volt DC volt meter and amp meter to monitor electrical flow and current. These 2 instruments can be valuable aids in basic electrical troubleshooting.

A 3 amp in-line fuse located on the rear side of the panel protects the blue soft indicator icon for each breaker.

Notice the CO and macerator covered breakers. These switches require a 2 step operation to actuate the component. The cover must be lifted before the switch can be activated. For more information read the sections on carbon monoxide and pumping waste overboard. Macerator (overboard discharge) usage requires the same 2 step process.



TYPICAL 12 VOLT MAIN DC PANEL METER/BREAKER SWITCH FUNCTIONS

PORT LEG

FWD. CABIN LTS- protects the overhead and reading lights.

MID CABIN LTS- protects the main cabin overhead and counter top lights.

AFT LTS- protects overhead and reading lights.

FRESH WATER- protects fresh water system pump.

MACERATOR- protects the overboard discharge pump which when allowed pumps waste overboard. To activate first pull the cover up and then turn on the breaker.

REFRIGERATOR- protects the refrigerator if installed below the cockpit grille aft of the sliding doors or may control the bridge refrigerator drawer unit.

FWD. HEAD- protects the forward head electrical circuit.

AFT HEAD- protects the aft head electrical circuit.

TV/LIFT- protects the refreshment center integrated television.

ACC- Controls the salon stove cut-out switch. **Note that the accessory switch must be in the “on” position for the salon stove to operate along with the stove top being removed from the stove and positioned in the track behind the helm seat. See the stove section for further information.**

STARBOARD LEG

STABILIZER- protects the optional seakeeper.

USB OUTLETS- protects the phone charging outlets.

TV ANTENNA- protects the antenna mounted on the hardtop.

HEAD VENT- protects the head vent motors.

STEREO- protects the stereo circuitry.

CO DETECTOR- protects separately the 3 CO detectors located in the forward, salon and aft staterooms. To access these breakers first pull the cover up from right to left. At this point the breaker can be turned off. For protection purposes these breakers shall be left in the “on” position.

LEVEL MONITOR- protects the fresh water and waste tank monitor located near the salon main AC panel.

SAT. TV- protects the satellite television circuit.

LOWER REFRIG- protects the lower cabin (salon) refrigerator.

ACC- protects the accessory breakers. Check the sizes of the breakers when adding additional components.



TYPICAL 12 VOLT HELM BREAKER SUB-PANEL



The helm breaker sub-panel protects various components located in the vicinity of the helm area. The sub-panel is controlled in part by the dash main breaker and the electronics breaker both located on the battery management center panel.

The sub panel is located in a locker located at the starboard helm area. In addition, various electronic controllers are found here.

The skipper should learn the location of all DC breakers on the vessel and the equipment they protect. For example, a breaker may trip on the sub-panel but may not trip the breaker on the battery management panel. Knowing his breaker location will aid the skipper in troubleshooting problems faster.

Remember, always find why a breaker “blows” before resetting it. Refer to the technical drawing section for additional information.

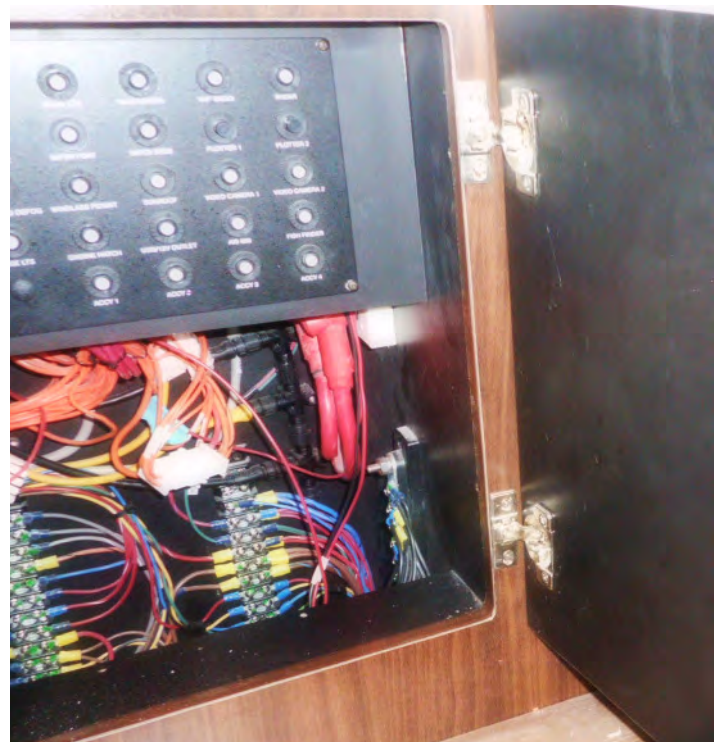

HELM SUB PANEL LOCKER



TYPICAL 12 VOLT HELM SUB PANEL BREAKER DESCRIPTION

HORN- protects the air horn located on the hardtop.	HELM SEAT F/A- protects the helm seat's forward and aft movement circuitry.
SPOT LT- protects the deck mounted search light.	HELM SEAT U/D- protects the helm seat's up and down circuitry.
TRIM TABS- protects the transom mounted electric-hydraulic trim tab circuit.	BATTERY PARALLEL- protects the battery parallel circuitry.
NAV LTS- protects the port and starboard deck navigation for night cruising.	WINDSHIELD DEFOG- protects the defogger motor circuitry.
PANEL LTS- protects the helm (dash) back-lit icons.	WINDLASS PERMIT- protects the windlass permit circuitry.
ELEC/NMEA- protects NMEA (NATIONAL MARINE ELECTRONIC ASSOCIATION) backbone and equipment..	SUNROOF- protects the motor that regulates the sun-roof circuitry.
VHF RADIO- protects the marine radio circuitry.	VIDEO CAMERA 1- currently not used.
RADAR- protects the closed array radar system.	VIDEO CAMERA 2- currently not used.
BLOWER 1- currently not used.	DECK LTS.- protects the deck light circuit.
BLOWER 2- currently not used.	UNDERWATER LTS.- protects the transom mounted lights (under platform) circuit.
BILGE FWD- protects the forward bilge pump.	HARD TOP LTS- protects the coupe hard top light circuitry.
BILGE AFT- protects the aft bilge pump.	BILGE LTS- Protects the bilge light circuitry.
WIPER PORT- protects port windshield wiper circuit.	ENGINE HATCH- Protects the engine lift actuator circuitry.
WIPER STBD- protects the starboard windshield wiper circuit.	USB/12 VOLT OUTLET- protects the 12 volt dash accessory outlet.
PLOTTER 1- protects the GPS/Plotter starboard dash mounted circuitry.	AIS 600- Currently not used
PLOTTER 2- protects the GPS/Plotter port dash mounted circuitry.	FISH FINDER- protects helm mounted Garmin finder.

*Note that the fly uses a separate bridge panel for plotters.



TYPICAL 12 VOLT HELM BREAKER SUB PANEL DESCRIPTION (CONTINUED)

GAS VAPOR DET- currently not used.

STEREO.- protects the Fusion stereo system.

ACCY 1,2,3, 4- protect the aftermarket accessory breakers.



TYPICAL 12 VOLT COCKPIT SWITCH PANEL



HATCH-

The hatch switch operates the forward opening engine compartment. With the forward opening feature you can use the swim platform to enter and exit the sump.

BILGE LTS-

This switch controls the underwater transom located LED style lights.

BILGE LTS-

This switch controls the lights in the engine compartment which is a true benefit while performing sump maintenance.

HTOP LTS-

This switch controls the lights in the cockpit hardtop area.

DECK LTS-

This switch controls the various lights illuminating the deck including the LED circuit.



TYPICAL 12 VOLT DIMMER SWITCH PANEL



The dimmer switch panel controls the salon dimming switches on the 3 gang panel at the port side of the steps at the atrium (steps to lower level). There is no normal maintenance to this panel. It is located just below the 3 gang dimmer light switches at the stairway.

The unit is LED compatible with a memory for last dimmer setting.

Also, the unit provide at the switch panel an illuminated exit with adjustable time delay.

To use the dimmer switches depress the desired switch for on and off. The lights will appear at their brightest mode. If you want to dim a particular switch circuit simply depress the lower portion of the switch and hold the switch in that position. The lights will dim until you release the switch.

To use the adjustable time delay exit feature;

1 minute delay- Hold the switch in up position (bright) for 2 seconds, lights will flash. Release switch after first flash and the lights will remain on for 1 minute.

2-5 minute delay- Hold the switch in up position (bright) for 1-4 seconds after the first flash. Release the switch after 2 to 5 flashes. The lights will remain on for 1 minute for each flash up to a maximum of 5 minutes.



TYPICAL DC (12 VOLT) WIRING COLOR CODE & SIZES		
BLACK	16,14,12,10,8,6,4,2,2/0,40	GROUNDS
BLACK/WHITE	16	HALON INDICATOR
BLACK/YELLOW	10,16	GRD. DIESEL TRANSFER PUMP, MERC DIESEL STOP CIRCUIT
BLACK/WHITE	10	HALON MAIN GRD. FEED
BROWN/BLACK	10	MACERATOR, SUN ROOF
BROWN	10	SUN ROOF
BROWN	14	AFT BILGE PUMP-MANUAL
BROWN/WHITE	14	AFT BILGE PUMP-AUTO
BROWN/RED	14	FWD. BILGE PUMP-AUTO
BROWN/BLUE	14	FWD. BILGE PUMP-MANUAL
BROWN/PINK	16	CO DETECTOR
BROWN/BLACK	16	SHOWER SUMP PUMP
YELLOW	12,10	BLOWER
YELLOW/WHITE	16	HEAD VENT FAN MOTOR
YELLOW/BLACK	16	STEREO MEMORY
YELLOW/RED	14	ENGINE START CIRCUIT

Note: The list above applies to a number of vessels. Vessel components/wiring may vary depending on the model.



TYPICAL DC (12 VOLT) WIRING COLOR CODE & SIZES		
ORANGE	10,12	VACUUM TOILET, REFRIGERATOR, HATCH RAM
ORANGE	16	WIPER RUN
ORANGE/WHITE	16	WIPER PARK
ORANGE/BLACK	10,12,16	HORN, HATCH RAM
BLUE	14	INTERIOR LIGHTS, SWITCHED CIRCUIT
BLUE/RED	14	INTERIOR LIGHTS, CONSTANT HOT CIRCUIT
BLUE/BLACK	16	COCKPIT SOFT LIGHTS
BLUE/GREEN	16	INTERIOR SOFT LIGHTS
BLUE	10	CABIN LIGHT MAIN CIRCUIT FEED
GRAY	14	NAVIGATION LIGHTS, RUN- NING, BOW, TRANSOM LIGHTS
GRAY/BLACK	14	NAVIGATION LIGHTS, AFT AN- CHOR, MASTHEAD
GRAY/WHITE	14	NAVIGATION LIGHTS, MAST- HEAD, FWD. RUNNING LIGHTS
RED	16	POSITIVE FEED- ELECTRON- ICS, GAS VAPOR DETECTOR, BREAKER TO DASH SWITCH FEEDS

Note: The list above applies to a number of vessels. Vessel components/wiring may vary depending on the model.



TYPICAL DC (12 VOLT) WIRING COLOR CODE & SIZES		
RED/WHITE	16	WINDLASS CONTROL-DOWN
RED/BLACK	16	WINDLASS CONTROL-UP
RED/WHITE	14	BATTERY PARALLEL-LOAD
RED	14	POSITIVE FEED-ELECTRONICS
RED	12	POSITIVE FEED-ELECTRONICS
RED	10	POSITIVE FEED-AUTO PILOT
RED/VIOLET	10	FUEL TANK TRANSFER PUMP AMPLIFIER POWER
RED	8	POSITIVE FEED- MAIN ALTERNATOR CHARGE
RED	6	POSITIVE FEED- MAIN ALTERNATOR CHARGE
RED	4	POSITIVE FEED-MAIN
RED	2	POSITIVE FEED- MAIN STARTER, BATTERY, GENERATOR
RED	2/0	POSITIVE FEED- MAIN, STARTER, BATTERY
PURPLE	16	STBD. IGNITION
PURPLE/WHITE	16	PORT IGNITION
PINK	16	STBD. FUEL TANK SENDER
PINK/BLACK	16	PORT FUEL TANK SENDER
TAN/BLUE	16	ENGINE ALARM CIRCUIT
GREEN	16	TANK LEVEL MONITOR, SPOT- LIGHT
GREEN	10	SPOTLIGHT
GREEN	8	BONDING

Note: The list above applies to a number of vessels. Vessel components/wiring may vary depending on the model.



TYPICAL (AC) ALTERNATING CURRENT-INFORMATION

OVERVIEW

Alternating current sometimes called AC current is brought on board through the use of a dockside shore-power) cord/reel system or produced on board through the generator. Just as a residential home uses 120/240 volts to run various household appliances and equipment the same holds true on your yacht.

With AC current electrons “cycle” in one direction a short distance and reverse themselves traveling in the opposite direction. This is how AC became known as alternating current. The rate that the current reverses itself is referred to as frequency. In the United States the alternating current frequency is 60 cycles per second. Overseas a 50 cycle frequency per second is standard. Component specifications must match the country’s frequency.

BASIC ELECTRICAL TERMS

Voltage is a measurement of the electrical potential that an electrical power source contains for doing some type of work for us. Think of it as electrical pressure. An example might be your yacht’s battery.

Amperage is a particular amount of electricity flowing through some part of a circuit. Think of it as the rate of electrical flow through your yacht’s wiring.

Resistance is measured in ohms and inhibits the electrical flow through a circuit. An example would possibly be an incandescent light bulb. The resistance in the light bulb element allows it to glow and brighten the cabin along with giving off heat.

It is important that you understand and respect the alternating current system used on board. Be sure to read and follow any danger, warning, or caution labels in reference to the yacht’s electrical system or individual equipment components. Most of all, use common sense!

INTRODUCTION- DOCKSIDE CORD USAGE

The dockside cord is the basic component used to deliver up to 50 amps of electricity from the marina dock power box to the yacht itself through the cord reel system.

Before plugging in the dockside power cord check to see that all yacht AC breakers are off. This includes the incoming as well as both the main and equipment breakers at the AC ship’s control panel. See the AC panel illustration later in this chapter.

When connecting the shore power cord be sure to twist the cord into the marina inlet plug. This motion will lock the plug in the socket.

There may be several types of inlet plugs located at the marina dock power center. Be advised that the 30 amp plug is much smaller looking and the 50 amp cord will not physically fit it.

Also, marina dock power centers normally have breakers that must be activated after installing the dockside cord. Make sure the dockside cord has enough slack to weather changing tides if applicable and at the same time does not come in contact with the water. Check with the marina dockmaster for more information on their shore power operation and requirements.

Before attempting to disconnect the shore power cord turn off all equipment and main AC breakers on the ship’s control panel to prevent any component damage. When disconnecting the shore power cord first turn the breaker to the “off” position at the marina dock power center. Then remove the dockside cord from the marina outlet.



DANGER

PREVENT BODILY INJURY, DEATH OR FIRE!
NEVER USE EXTENSION CORDS
OR IMPROVISED CORDS
IN SHORE POWER/MARINA INLETS.
USE ONLY APPROVED MARINE
SHORE POWER CORDS
MATCHING THE ORIGINAL
WIRE GAUGE AND AMPERAGE.



WARNING

PREVENT SEVERE INJURY OR DEATH!
ALTERNATING CURRENT (AC) CAN KILL YOU!
DISCONNECT
ALL ELECTRICAL POWER SOURCES
BEFORE ATTEMPTING
TO REPAIR OR REPLACE
ANY ELECTRICAL COMPONENTS.

Typical domestic dockside cords (sometimes called the shore power cords) usually contains four wires:

White-neutral ungrounded conductor

Green-grounding conductor

Red-ungrounded conductor containing 120 volts

Black-ungrounded conductor containing 120 volts

CABLE REEL USAGE



Your yacht features a DC powered cord reel system for reeling in the dockside cord. The dockside cord is rated at 50 amps and is attached to a reel which releases the needed cord length when pulled out. The power cord is accessible from just above the aft platform. The reel is located in the aft bilge. The power cord retrieval is accomplished by activating a switch which powers the 12 volt DC motor.

The yacht end of the cord is directly wired into the cord reel. Therefore, there is nothing to be plugged into the yacht.

The marina end must be plugged into the marina dock power center using the same procedure as the standard dockside cord.

The illustration on the next page shows a typical transom layout with the cord reel system. Notice the cord reel switch for cord retrieval.

To operate the switch, press **RELEASE** on switch to unlock reel before pulling cord.

Next, press **RETRACT** on switch to retrieve cord on to reel.

Once the cord is inside the inlet be sure to close the cover to reduce the effects of any water intrusion.



TYPICAL TRANSOM VIEW- CORD REEL SYSTEM



POSSIBLE PROBLEMS/SOLUTIONS

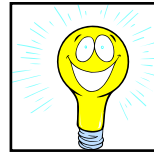

1. After the dockside cord is hooked up to the marina dock power center and the AC ship's panel main breaker for shore-power 1 or 2 is activated no voltage is shown on the main panel AC volt meter.

Check the breaker on the marina dock power center to ensure it is activated.

Check the ELCI 3 pole single throw breaker/voltage sensing device. The "power" icon should show green. If a leakage fault exists a "red" icon will light indicating the breaker is "tripped". Use the test button to reset the breaker.

2. The marina dock power center lacks a 50 amp plug.

Call the dockmaster or marina personnel. An adapter cord may be available. NEVER IMPROVISE ANY TYPE OF CORD OR POWER INLET CHANGES! Also, an adapter cord may be purchased that delivers twin 30 amp service and adapts to the 50 amp yacht dockside cord. Adapters can be found at retail boating outlets.

3. The cord reel switch fails to retrieve the dockside cord.

Check the cord reel breaker located on the battery management panel.



ELCI SYSTEM

TYPICAL ELCI SYSTEM OVERVIEW

Normally shore power travels from the marina dock-side plug through the cord reel to a main ELCI breaker with leakage fault technology. Power continues to the ship's main AC control panel culminating at the shore power main and auxiliary equipment breakers.

The ELCI single pole breaker is set up to trip should an overload or fault occur between the breaker itself and the main AC control panel. If the 50 amp ELCI breaker trips find the cause of the problem before resetting the breaker.

The ELCI stands for "Equipment Leakage Circuit Interrupter". There are two potential failures in a boat's electrical system that can put people on or around a vessel at risk of lethal electrical shock. In a properly functioning marine electrical system, the same amount of AC current flows in the hot and neutral wires.

However, should electricity "leak" from this intended path in these two wires to ground, this condition is referred to as a "ground fault". An example of this is an insulation failure in the wiring of an appliance.

Furthermore, a ground fault can occur when the grounding path is broken through a loose connection or broken wire. As an example a shore power ground wire may fail due to fatigue caused by constant motion and stress. Faulty grounds can go undetected; a simple continuity test may not reveal problems.

When these 2 conditions occur at the same time, it may produce tragic results. The combination of a "ground fault" and a faulty ground could result in the metal parts of the vessel and underwater gear to become energized. If this condition exists, besides being a hazard to personnel on board there is increased danger to swimmers near the boat. The result could be shocking people on board and swimmers could receive a paralyzing dose of electricity and drown due to loss of muscle control.

An ELCI provides protection for the entire boat and features a trip threshold which provides ground fault protection for the entire shore power system beyond the ELCI.

The ELCI protection on individual shore power lines combined with GFCI'S will reduce the risk to those on the boat, dock, and in the water surrounding the vessel.

Notice that one ELCI breaker is marked shore power 1 and the other ELCI breaker shore power 2.

Another feature of the ELCI is a "leakage fault" detector located on the side of the ELCI breaker itself. The leakage fault feature detects a change in the neutral wire current. Should the current change more than 30 milliamperes or about 1/3 of an amp the unit senses the difference and will "trip" the breaker causing the leakage fault LED to illuminate red. This clearly indicates that the trip occurred as a result of leakage. Before resetting the ELCI breaker determine the cause of the leakage fault.

A proper operating alternating current system will display a green illuminated LED at the "power" marked area of the ELCI.

Periodically test the ELCI by depressing the "test" button. The breaker should "trip" indicating the system is functioning properly. Simply reset the breaker. The leakage hazard helps prevent serious equipment damage and possible fire.

After the neutral and the 2-120 volt conductors exit the ELCI they run directly to the ship's main AC control panel.

The ELCI can at times undergo a process called "nuisance tripping" which can cause a "tripped" breaker. This can be caused by overloads in the electrical draw or sometimes caused from unbalanced loads. One way to minimize the situation should it occur is to monitor closer the energized devices on the vessel which will assist in keeping the total amperage used to a minimum and the loads between panel legs more balanced.

Note: It is always a good practice to keep the AC panel legs as balanced and always turn off breakers not in use. Your vessel is not like a home with unlimited energy re-

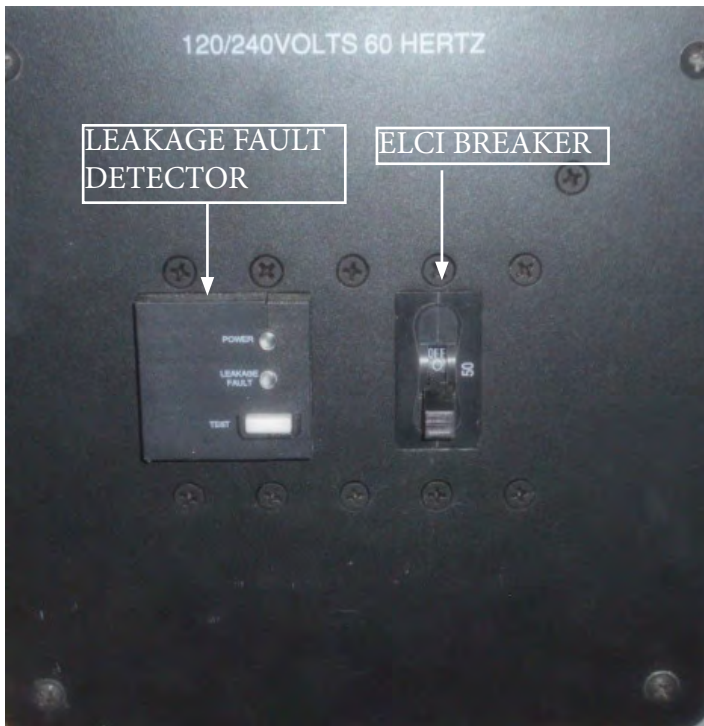

ELCI LEAKAGE FAULT DETECTOR LED INFORMATION

As a central segment of the ELCI system there are two LED lights with a “test” button located at the shore power inlet. With the breaker in the ‘on’ position and the shore power cord hooked up these LED lights may show variations in color to provide system conditions. They are:

1. Green LED On- Red LED Off
Line voltage is present, the breaker is closed, and the device is protecting the circuits against over current and leakage current.
2. Green LED Off, Red LED On
The device has detected leakage current and has opened the circuit breaker.
3. Green LED flashing, Red LED Off
The circuit breaker has opened due to overcurrent or has been manually turned to the “off” position.
4. Green LED Off, Red LED Off
Line voltage is not present. Check cord connections and marina breaker for “on” position.
5. Green LED flashing, Red LED Off, Amber LED On
Indicates hot and neutral are reversed and the circuit breaker is open.

Note: Check circuit at least monthly by pushing in the white switch marked TEST. When depressed, the breaker should return to the reset position indicating the ELCI circuit is operating properly.

For further information on the ELCI PC-S refer to the Carling web-site. Both shore power 1 and 2 use the same testing procedure.



TYPICAL GALVANIC ISOLATOR

As part of the AC boat circuitry the green ground wire takes a different path. It exits the yacht shore power inlet or cord reel and travels to a galvanic isolator. See the illustration.

A 60 amp (60 hertz) galvanic isolator for domestic use is connected in series with the AC grounding “green” wire. Overseas yachts use a 30 amp (50 hertz) galvanic isolator.



The purpose of the galvanic isolator is to isolate the yacht’s grounding system from the shorepower ground. The

galvanic isolator allows AC voltage to travel back to the green ground wire at the marina power center in the event a short exists on the boat. Also, the isolator blocks any DC current from traveling on the green ground wire. This eliminates the possibility of galvanic interaction from other boats in the vicinity.

The green ground or “bonding wire” runs from the yacht’s shore power inlet or optional cord reel to the galvanic isolator. From the output of the galvanic isolator it runs to the AC ground buss located behind the AC main control panel in the salon.

Since the galvanic isolator is not polarized either terminal can be used for the inlet or output side for the green grounding wire. See the illustration.

There is a fan located inside the isolator. If you ever hear the fan running the isolator has failed. Disconnect the shore power from the boat and check the system. Call your closest Regal yacht dealer for more information.

Do not to store objects inside the locker that might inhibit air flow to the galvanic isolator fan.

Normally the galvanic isolator is found in the lower aft stateroom locker on the bulkhead (wall) near the forward most bed.



TYPICAL AC ELCI CIRCUITRY FLOW CHART

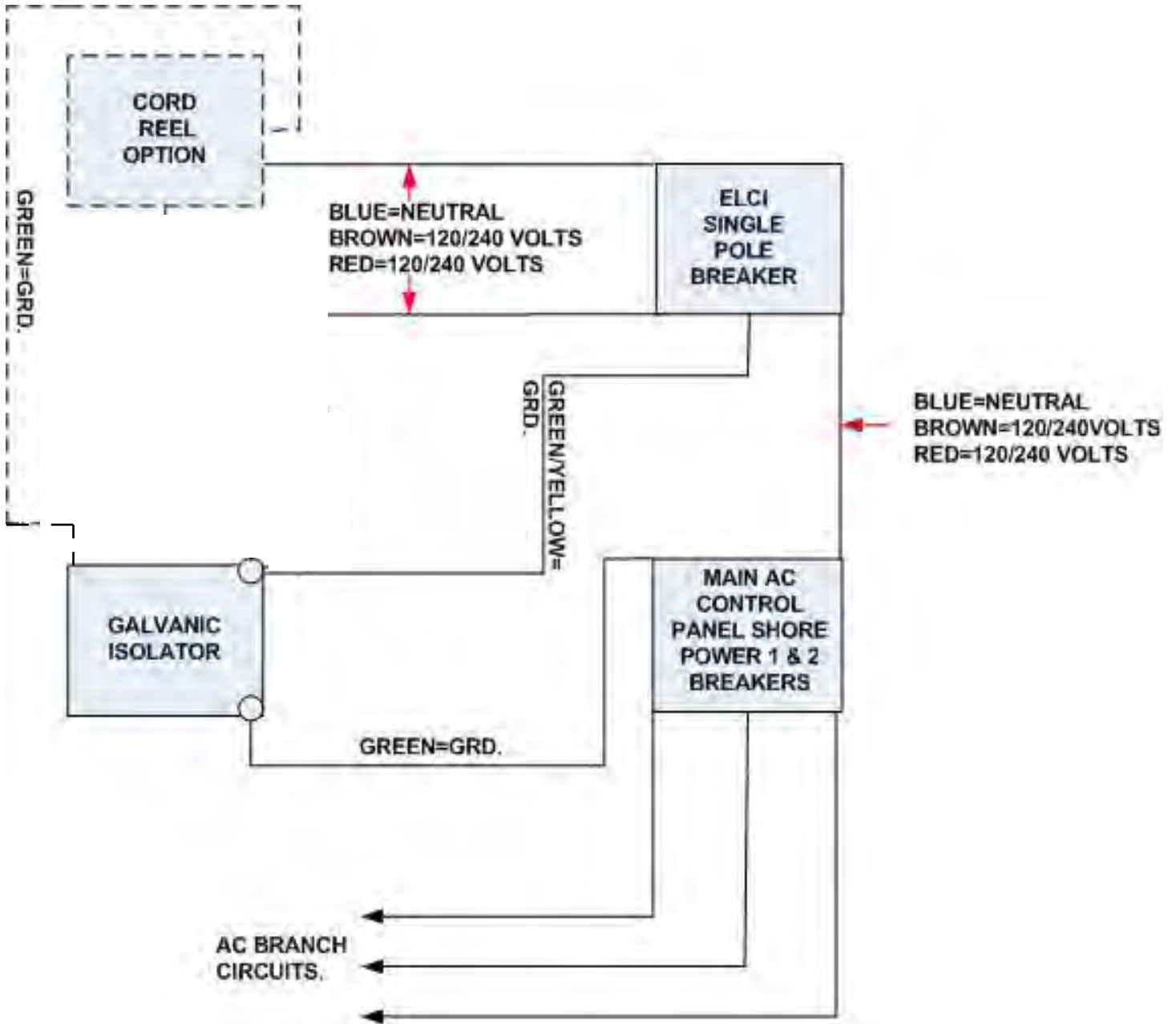



TYPICAL MAIN AC PANEL



TYPICAL MAIN AC PANEL METER/SWITCH FUNCTIONS

The typical main AC 120/240 volt control panel is located at the starboard salon in an area called the atrium. Open the cabinet doors to gain access to the panel. The main call outs on the panel will be addressed. This panel serves as the primary distribution for the incoming shore power from the marina power center or from the ship's generator when at cruise. The ship's main DC panel is located along side of the AC panel. Information on the DC panel is found earlier in this chapter.

SHOREPOWER PANEL DISTRIBUTION

As noted earlier the shore power cord delivers AC electricity through the yacht's cord reel system ending up at the ELCI system. Upon ELCI breaker activation, current travels to the main AC 120/240 volt ship's panel. AC electricity is now ready to be distributed to the various equipment components.



TYPICAL AC MAIN YACHT CONTROL PANEL

REVERSE POLARITY INDICATOR

Before activating the 50 amp main breaker visually check for a green light at the reverse polarity indicator. The green light indicates there is no reverse polarity. If the red light appears on the reverse polarity indicator a hot wire and ground are probably reversed somewhere in the circuit from the dock to the main panel. The ELCI breaker will “trip” if a reversed polarity situation develops. Also, it is possible that the main 50 amp shore power inlet breaker will “trip”.

In all cases do not activate the main 50 amp breaker. Take immediate corrective action to find the cause of the reverse polarity situation. At this point, disconnect the shorepower cord from the marina power center and call for professional assistance.

50 AMP MAIN BREAKER

As previously stated the AC panel mounted single throw, triple pole main breaker controls power to the 120 and 240 volt sections of the panel and eventually delivers electricity through a system of sub breakers to the entire yacht. Before you energize the breaker it is always a good idea to check all the legs on both the 120 volt and 240 volt side for breakers that are in the “on” position. Turn any breakers found “on” to the “off” position. This prevents any excessive equipment motor draws and may eliminate any system arcing.

With the reverse polarity indicator showing the green icon, activate the main breaker by pushing the single throw arm up. AC electricity now is distributed to both the 120 and 240 volt legs of the panel. Turn on sub breakers as needed always being conscious of the load current meters..

50 AMP AC GENERATOR BREAKER

When the yacht is under generator power at sea AC electricity is distributed through the main generator breaker located on the AC main ship’s panel beside the main breaker. See the previous illustration and the generator section for further information.

Before activating the generator AC breaker it is recommended to make sure all the equipment breakers are “off.” Slide the bar to the left so the generator breaker arm will clear when activated. Push the single throw arm up to energize generator AC current to the sub panel breakers. Switch on the sub panel breakers as needed.

LINE VOLTAGE/CURRENT METERS

After the shore power 50 amp main breaker or generator breaker is activated line voltage up to 240 volts will display on the 240 volt (right side) of the main panel. As sub panel 240 volt equipment breakers are activated the load current meter (extreme right side of 240 volt panel) will show an amperage draw. Normally the amperage will ascend as more equipment breakers are activated and will descend as equipment breakers are deactivated. After the main panel breaker or generator breaker has been activated no voltage will appear on the 120 line voltage meter at the extreme left side of the main control panel with the 120 shore power switch in the “off or center” position. This is normal. See the illustration. The 120 volt shore power switch is located between the line voltage and load current meters. See the illustration.

As stated above with the shore power switch in the “center” position it is off. When the shore power switch is moved to Line 1 the line voltage meter will display up to 120 volts available at leg A. As equipment breakers are activated the load current (amperage) meter will ascend and descend as equipment breakers are deactivated.

When the shore power switch is moved to Line 2 the line voltage meter will display up to 120 volts available at leg B. As equipment breakers are activated the load current (amperage) meter will ascend and descend as equipment breakers are deactivated.

When the shore power switch is in the center position 240 volts will show in the right line voltage panel.

It may be necessary to leave the battery charger on during extended periods. Since the cabin refrigerator is dual voltage (12 and 120) make sure the DC refrigerator breaker is activated and the AC refrigerator breaker is deactivated upon leaving the vessel.



120 VOLT MAIN PANEL BREAKER DESCRIPTION (TYPICAL)

Leg A

Fwd. Outlets- This 15 amp breaker controls the 120 volt GFCI and outlets downstream.

Ice Maker- This 10 amp breaker controls the cockpit ice-maker if installed.

Microwave- This 15 amp breaker controls the galley microwave.

Entertainment- This 10 amp breaker controls the salon (main stateroom) entertainment center.

SAT TV- This 10 amp breaker controls the satellite television circuit.

Central Vacuum- This 15 amp breaker protects the vacuum system installed near the main cabin entry stairway below the AC-DC locker.

Leg B

Aft Outlets- This 15 amp breaker controls the 120 volt GFCI and outlets downstream.

Refrigerator- This 15 amp breaker controls the upper salon refrigerator. This unit is dual voltage which means it can run on 120 volts AC or 12 volts DC electricity. See the note on the previous page regarding leaving the yacht with the refrigerator in the operational mode.

Washer/Dryer- This breaker is not used.

Lower Refrigerator- This 15 amp breaker controls the lower cabin refrigerator if installed in the refreshment center.

Acc- This 10 amp breaker provides for additional aftermarket components.

Water Heater- This 15 amp breaker controls the water heater located in the engine room (bilge). Never turn on this breaker without water in the system as the water heater element will be damaged and replacement will be needed.

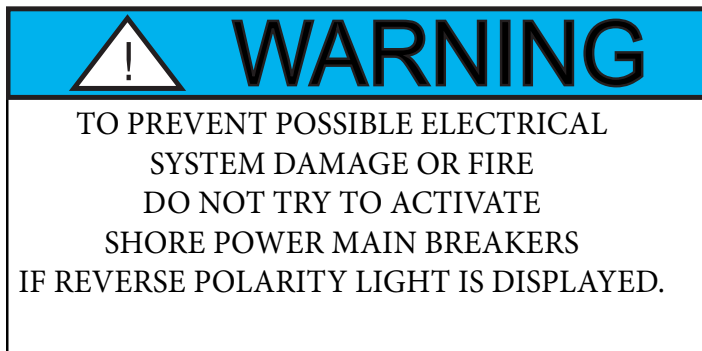



240 VOLT MAIN PANEL BREAKER DESCRIPTION (TYPICAL)

Leg C- 240 Volt Leg

Fwd. Air Cond- This 30 amp breaker controls the forward air conditioning unit.

Aft Air Cond- This 30 amp breaker controls the air conditioning unit.

A/C Pump- This 20 amp breaker controls the air conditioning pump located in the engine room (bilge). This pump supplies water to the forward air conditioning unit and the aft air conditioning unit along with the "cool cockpit" unit if installed.

Cool Cockpit- This 40 amp breaker controls the air conditioning unit.

Battery Charger- This 20 amp breaker controls the battery charger located in the engine room (bilge). It is recommended that when leaving the yacht for extended periods this breaker be left energized in order to keep the ship's batteries in a charged condition.

Cockpit Grill- This 30 amp breaker controls the cockpit grilling device.

STABILIZER- This 30 amp breaker controls the gyro driven Seakeeper stabilizer.

Stove- This 20 amp breaker controls the galley stove.

Note: Some of the listed equipment may be optional.

TYPICAL AC WIRE USAGE	
GAUGE	FUNCTION
6/4 Romex Boat Cable	Generator Output
6/4 Romex Boat Cable	50 Amp Service
10/3 Romex Boat Cable	30 Amp Service
10/3 Romex Boat Cable	A/C Main Power Supply
10/3 Romex Boat Cable	Stove Power Supply
14/3 Romex Boat Cable	A/C Pump, Power Pump Relay
14/3 Romex Boat Cable	Receptacles, Microwave, Water Heater, Refrigerator, Ice maker, Central Vacuum System



GFCI Outlet

Sometimes current in a circuit escapes its normal route and finds a “ground fault”. If that vehicle ends up to be your body and the current passes through your heart the results could be deadly.

A ground fault interrupter or GFCI senses the difference between the hot and neutral wire current before a fatal dose can be conducted and in a fraction of a second cuts the current.

Your yacht uses 120 volt receptacles. By using a GFCI as the first receptacle in the circuit all the receptacles down stream on the same circuit are protected by the initial GFCI. This is accomplished by attaching the hot wire to the line terminal of the GFCI receptacle and the outgoing hot wire to the load terminal. The neutral wires also use line and load terminals on the opposite side of the GFCI receptacle.

You can identify the GFCI primary receptacle by the test and reset breaker in the center of the device. Check the GFCI protection monthly. If a problem develops with the GFCI circuitry call a marine electrician to access the situation.

The GFCI outlets are especially useful when electrical equipment is employed such as a drill or in the bathroom with the use of personal devices such as curlers and hair dryers. Never use any electrical devices when puddling water is present to prevent a possible shock hazard.

GFCI'S (GROUND FAULT CIRCUIT INTERRUPTER

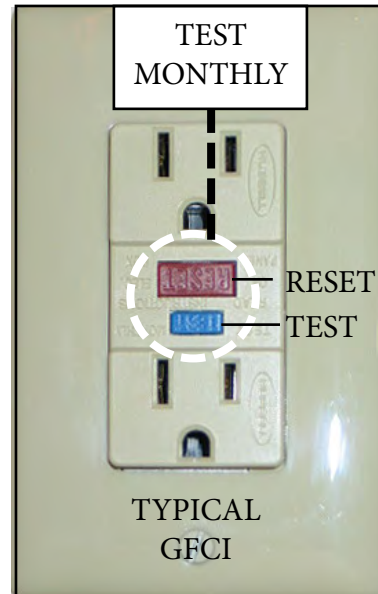

The GFCI is programmed to protect a person from line to ground shock hazards which could occur from various electrical devices operating off of the device or receptacles down stream. It does not prevent line to ground electric shock, but does cut down the exposure time to a fraction of a second before the device trips. It does not protect people against

line to line or line to neutral faults. Also, it does not protect against short circuits or overloads; this is the circuit breakers job.

All GFCI's should be tested monthly to make sure they and the receptacles they protect “down stream” are protecting against ground-faults.



Testing GFCI'S

To test a GFCI on your yacht find a 120 volt night light or small lamp to plug into the GFCI outlet. Try it in another circuit first to make sure it lights.

After the lamp is plugged into the GFCI outlet the lamp should light. Now press the “test” button at the GFCI receptacle center. The GFCI’s “reset” button should pop out and the lamp should go out. This means the GFCI itself is functioning properly. Press the “reset” button to restore power to the outlet. Test each GFCI circuit monthly.

You can use the lamp to check receptacles down stream from the GFCI. All receptacles should light the lamp and should go out when the “test” button is pressed.



Also, GFCI down stream receptacles can be tested with a plug-in type GFCI tester. This tester contains a GFCI test button which accomplishes the same thing as the GFCI receptacle built-in test button. This tester can be purchased at electrical supply houses or marine retailers.

Ignition Protected Devices

Many electrical devices in everyday use tend to “arc” or spark when being used. These include motors, fans, switches, relays, etc.

Boats in general use many of these same devices but they are protected from any sparking that may cause the device to ignite with any vapors that are typically found in the engine room and/or fuel tank compartments.

Obviously, gasoline powered vessels contain a much higher risk of explosion over diesel powered vessels but diesel under the right circumstances can ignite and burn. Still when replacing any electrical device especially in the bilge or engine room make sure it is ignition protected. This means it has been tested and normally the device is stamped with a marking making it safe to use. Most automotive type devices are not ignition protected especially engine starters and alternators.

POSSIBLE PROBLEMS/SOLUTIONS (GFCI'S)

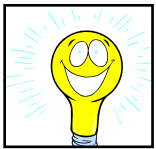

1. If the “reset” button does not pop out, the GFCI is probably defective and should be replaced.
2. If the “reset” button pops out one time but tends to stick the next the GFCI should be replaced.

3. The GFCI “reset” button pops out when something is turned on. This may indicate an internal wiring problem with the GFCI or there may be a ground-fault down stream.

4. The GFCI “reset” button is in the pressed position and nothing works. Check the appropriate breaker at the main ship’s AC control panel to make sure it has not “tripped” or as been deactivated.



TYPICAL AC GENERATOR (GEN-SET)

OVERVIEW

The 11 Kw diesel generator (gen-set) is used to provide on board alternating current (AC) when the vessel is unplugged from the dockside cord. Generator frequency known as hertz is domestically set at 60 while overseas countries normally require a setting of 50. As the generator reaches full rated no load output (amps) at 60 hertz it should display 120 volts. At 50 hertz it should display 230 volts.

The generator is located in the engine room. Some basic system components are identified below.



The generator features a sound enclosure which reduces noise and enables quick access for most inspections, troubleshooting and routine maintenance.

Note that above generator shown with sound enclosure removed.

Refer to the generator owner's manual for additional information.

Typical Generator Fuel System

The generator is supplied by the same fuel tank as the engines. The generator fuel and return valve are normally marked for identification purposes (See the earlier fuel tank photo in the fuel section). The feed valve features off and on positions. "Off" position is 90 degrees perpendicular to the valve. "On" position is in line with the valve. The return generator valve is located on the forward top of the port fuel tank. Familiarize yourself with the location of all equipment and valves.

Note: Normally the generator feed and return use a 3/8 inch barb located on the fuel tank.

The fuel system features an in-line remote fuel filter located close to the generator (see photo on next page). It's job is to keep fine particles and water out of the generator fuel injection system. Refer to the vendor information for periodic maintenance schedules. Clean fuel is the life line of diesel engine performance.

Note that there is also an integrated fuel filter that can be accessed by removing the sound enclosure.



TYPICAL GENERATOR INTEGRATED FUEL FILTER



Draining Collection Bowl

Since water is heavier than fuel it will settle in the collection bowl at the bottom of the element. The vendor recommends inspecting/draining the collection bowl daily. To check/drain the element loosen the drain plug on the bottom of the collection bowl. Use an environmentally safe container to catch any contaminated fuel. Dispose of according to local, or state regulations. Close the drain snugly when finished to prevent any fuel leakage.

Note: Water in diesel fuel will gather at the bottom of a container since it is heavier than diesel fuel and will appear as a different color and consistency.

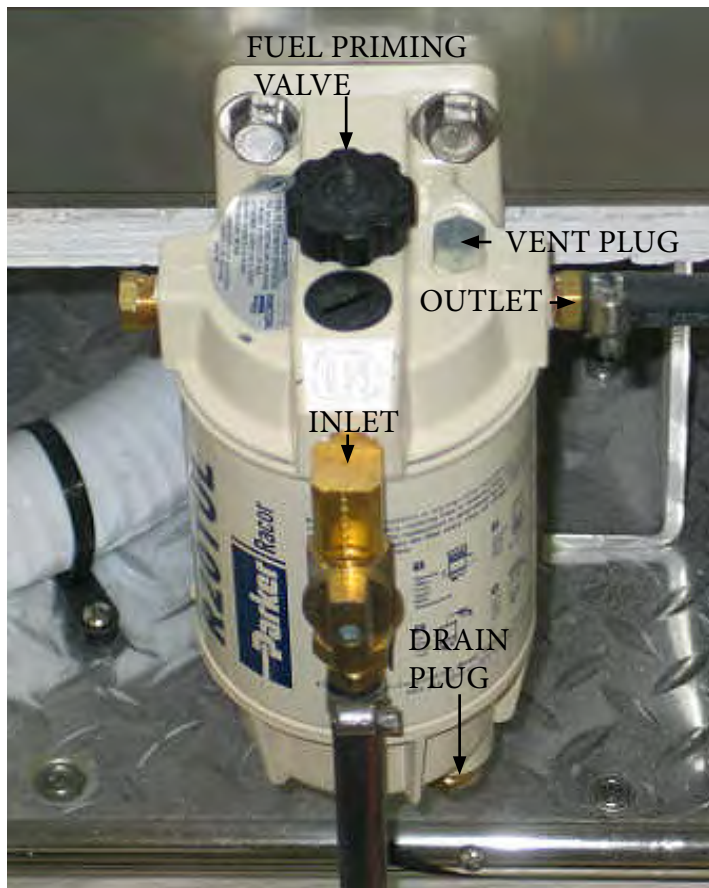

TYPICAL GENERATOR EXTERIOR FUEL FILTER

Changing Element

The element due to contaminated fuel needs to be changed periodically. Be sure to close the generator fuel tank valve located in the engine room berth before changing the element

Signs of necessary element replacement may be power loss, hard starting or large levels of contaminants/water in the element collection bowl when drained.

To replace the element first remove the old one by turning it in a counterclockwise direction by hand. Be sure to have a pan in place to catch any dripping fuel. Coat the new element and O ring with fresh diesel fuel and then thread the element clockwise by hand until snug. Do not use any tools.

Loosen the vent plug. Turn the primer valve counterclockwise until fully open. Turn on the generator fuel tank valve located under the master state room berth. Hand operate the primer valve up and down until the element is full as seen by fuel purging at the drain plug. Bleed the system as needed. Close the vent plug snugly. Close the primer valve by turning the valve clockwise until tight.

Start the engine and check for fuel or air leaks.

Bleeding System

Periodically air may need to be bled from the generator fuel system. Basically as stated above loosen vent plug and the hand operated fuel primer valve. Pump the primer until a solid stream of fuel comes out of the plug verses some fuel and some air bubbles. Tighten all components until snug.



Typical Electrical System

The generator starting system uses the port cranking battery. The generator is normally started at the 12 volt ship's control panel located in the atrium but it can also be started using the remote instrument panel located at the generator itself as needed. The latter is especially useful while maintenance is being conducted.

Note that the preheat process is automatically controlled when activating the start switch either at the main atrium panel or the integrated remote panel at the gen-set. Refer to the generator manual for further information.

The breaker at the generator performs a dual function. First it protects the unit from excessive draw. Also, it guards the output wiring from the generator to the main ship's AC panel. In addition, this breaker can be turned off while the generator is being serviced.

NOTICE

TO PREVENT POSSIBLE GENERATOR
DAMAGE ALL SHORE POWER
BREAKERS AND AC SWITCHES
NEED TO BE DEACTIVATED BEFORE
STARTING OR STOPPING GENERATOR.

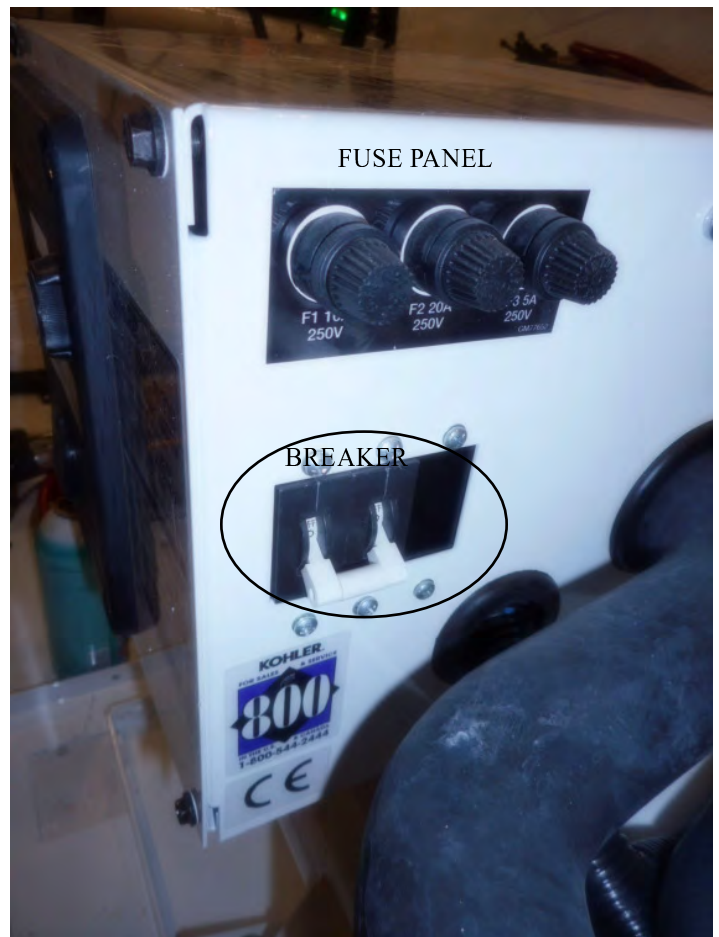

TYPICAL GEN-SET ELECTRICAL PANEL



TYPICAL GEN-SET MAIN PANEL

At the main AC-DC panel located at the atrium is found the main generator start panel. There is an 3 position switch which designates the following:

Up position-Momentary Start

Mid position-Off

Down position-Momentary Stop

Since diesel generators do not require a breaker note that the blower breaker located to the right of the switch is inactive and does not carry any load since there is no blower installed for the generator. Leave this breaker switch in the off position.

TYPICAL GEN-SET REMOTE PANEL

As part of the generator electrical system fuses protect the gen-set circuitry wiring. These fuses are located at the remote panel. See the illustration on the previous page.

On select models a breaker protects excessive current draw or electrical overload anywhere in the generator engine wiring. Should this breaker trip the generator will shut down.

Reset the breaker only after the cause of the problem has been determined. An AC breaker will automatically disconnect any generator AC power from reaching the main ship's control panel in case of an electrical overload. It can be manually shut off when performing generator maintenance to ensure no AC power is coming out of the generator.



TYPICAL GEN-SET REMOTE ELECTRICAL PANEL



GENERATOR SOLENOID VALVE

A scoop on the hull bottom assists in delivering the required amount of sea water to the generator. The sump mounted solenoid valve electrically opens when the generator is running allowing water flow to the generator. When the generator is shut down the solenoid valve closes which keeps water from reaching the generator.





Typical Exhaust System

The diesel generator exhaust system features a dual tier operation. As the water and exhaust exit the generator they travel to the muffler. The muffler discharges the heavier water out the muffler bottom and through the hull. The exhaust itself is exited out the muffler top and through the hull. The benefits of the system are two-fold. First, the actual decibel or sound level is decreased. In addition, the lower resonating sound is more pleasing to the ear. For colder climates, note that a drain plug is installed in the muffler.

TYPICAL GENERATOR MUFFLER

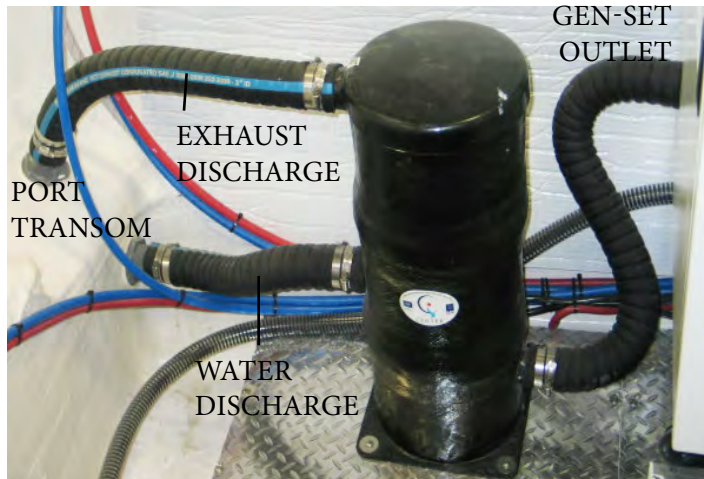

Before departure always check the hose connections for signs of water and air leaks. Tighten hose clamps as needed.

Before Starting Generator

The following items should be checked each time before starting the generator. This covers the basic system components.

- Turn generator seacock off. Check strainer for debris. Turn generator seacock ON before starting generator.
- Ensure that all main panel and equipment breakers are off.
- Inspect the generator for fuel, oil, exhaust or water leaks.
- Check generator engine oil level. Top off with correct viscosity as required.
- Check coolant for proper level at recovery tank. Add as needed.
- Check the main fuel tank to ensure there is adequate diesel for both the generator and the engines. Apply the one-third rule.
- Check for loose wires at the alternator.
- Check the port side cranking battery (weekly).
- Check drive belts for wear and proper tension (weekly).
- if available, record the hour meter reading to meet maintenance scheduling.



Starting Generator



The following generator starting information is specified for use at the ship's main control panel located in the atrium.. Note that the generator can be started or stopped by using the remote switches located at the generator in the engine room. It also assumes that the checklist on the last page has been completed and all system components are in operating condition. For further information, contact your closest Regal yacht dealer or refer to the generator operation manual.

1. Position the generator seacock to the "open" position.
2. Check the ship's main control panel to ensure shore main and all equipment breakers are deactivated.
3. At the ship's main control panel find the generator on/off switch. Activate the "on" switch and hold until the generator starts.
4. Once the generator starts, release the switch.
6. Let the generator run without a load for several minutes.
6. At the ship's main control panel slide the transfer bar completely to the left. This will permit the 60 amp AC generator breaker to be activated. To activate the breaker flip it up. At this point AC voltage should display on the AC line voltage meter.
7. Activate the desired AC equipment breakers.

Stopping Generator

To stop the generator follow these steps at the ship's main control panel.

1. Turn to the "off" position all AC equipment breakers.
2. Turn to the "off" position the 60 amp AC generator breaker. At this point, no AC line voltage will be displayed at the AC volt meter. Let the generator run for 3-5 minutes without a load to cool down.
3. Stop the generator by pressing down the "stop" switch at the main panel . Hold it down until the generator stops running.
4. If desired plug in the appropriate dockside cord. Slide the transfer bar completely to the right. Flip up the shore main 60 amp breaker for dockside power. AC voltage should display on the AC line voltage meter.

POSSIBLE PROBLEMS/SOLUTIONS

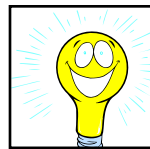

1. With generator main control panel activated there is no voltage at the AC line voltage meter. Check AC output breaker at the generator remote panel. It may of tripped due to an overload.
2. The generator quit do to overheating. Check the generator strainer for obstructions such as seaweed, plastic, or shellfish. Be sure to turn off seacock before removing the strainer basket.
3. The generator will not crank over to start. Check the port cranking battery by starting the port engine. If it starts battery is up. Then check all generator battery connections. Tighten any loose connections.



TYPICAL AIR CONDITIONING SYSTEM

Overview

The current air conditioning zone system features 3 separate marine air conditioning units. The system utilizes a single 230 volt pump which delivers cooler seawater to the evaporators/condensers (See photo at right. Warmer seawater exits the yacht through a manifold and various thru-hull fittings.

Each of the evaporator/condenser units incorporate a compressor to compact the R-22 refrigerant.

Three Elite control panels (thermostats) are centrally located to serve their respective areas.

TYPICAL A/C PUMP



The A/C pump is located in the engine room at the starboard aft bilge floor. It provides sea water to operate the A/C unit located under the forward berth, at the salon dinette, and behind the salon refrigerator.

lon dinette, and behind the salon refrigerator.

TYPICAL AIR CONDITIONING EVAPORATOR/CONDENSER UNIT

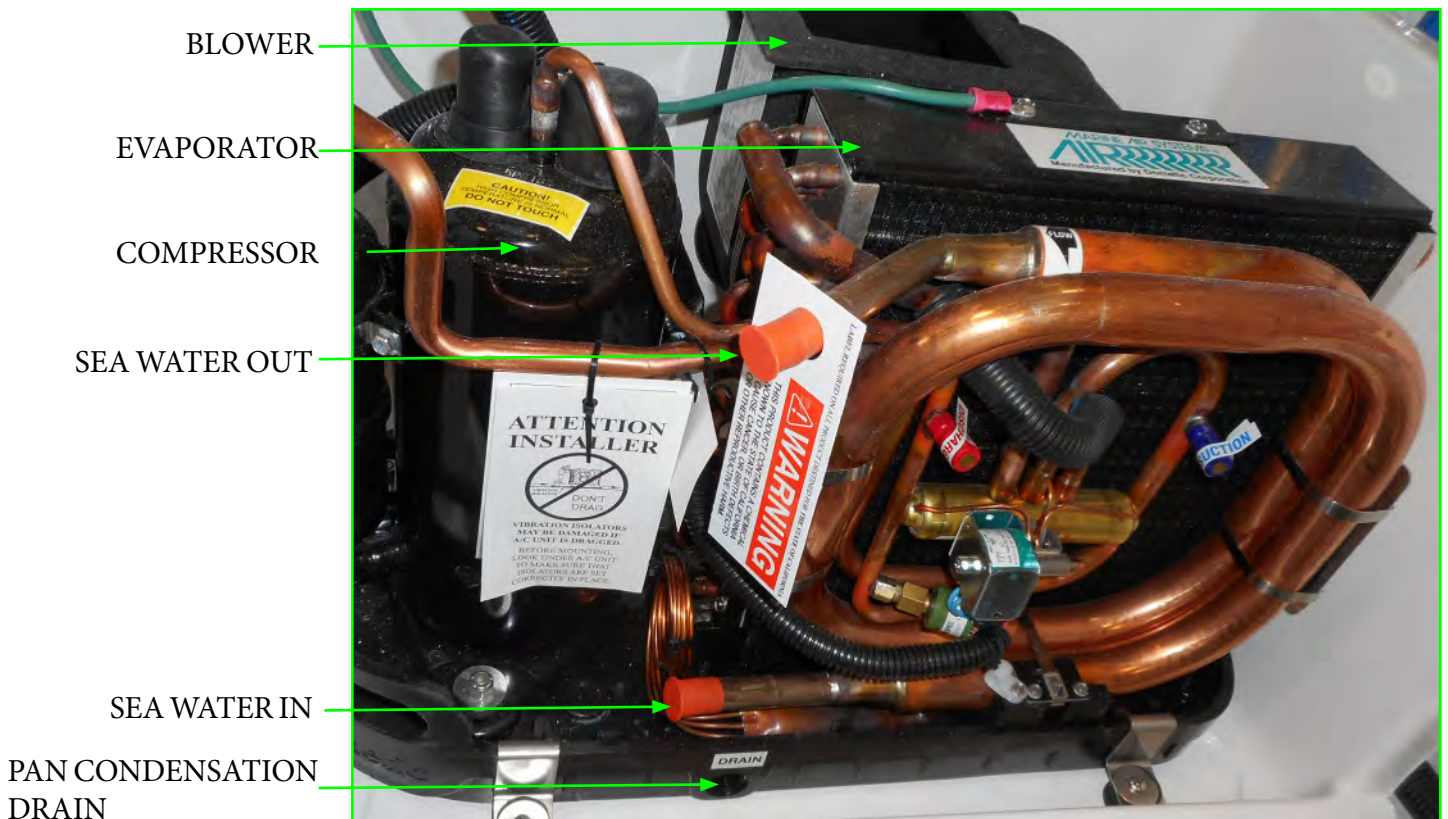



Introduction

The forward air conditioner unit serves the lower cabin. The following basic information locates each of the air conditioning units along with tips on how to access the condenser unit filters for periodic maintenance.

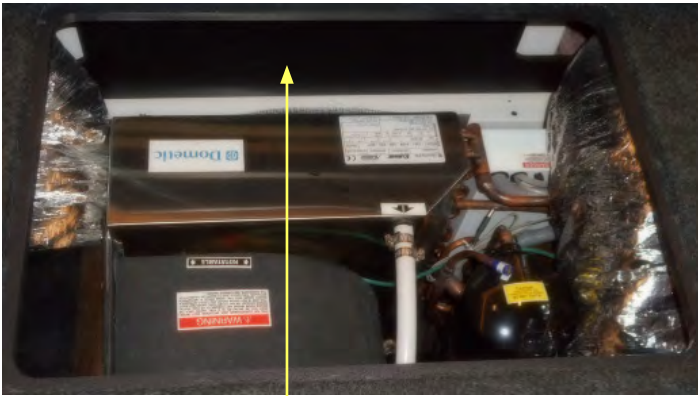

FORWARD AC UNIT FILTER

The forward air conditioning compressor and condenser units are accessed under the forward berth. Remove the bedding and the covered panel to access the unit. The filter is a gray mesh material at the aft compressor grid. Clean with soap and water. Rinse dry and reinstall filter.



Note that to the port and starboard lower sides of the berth are found air conditioner intakes for the forward air conditioner unit. These grates mix air and are part of the return air system.

Note that these intakes must not be covered by any objects since it may interfere with the ability of the AC unit to function properly.



Chapter 4

The port side air conditioning compressor and condenser units are accessed at the salon sofa area. Remove the aft and next forward cushion. You will see a wooden panel. Remove the screws on both ends of the panel to access the air conditioning compressor and condenser unit.



PORT AC UNIT

The port side air conditioning return air filter is found at the aft vertical section of the sofa. Move the sliding glass doors as needed to access the return air filter. Move the 2 locking tabs to release the air return cover. At this point you will be able to remove the gray mesh filter. Clean with soap and water. Rinse dry and reinstall filter. Cover return air grille and lock with tabs. See photo below.

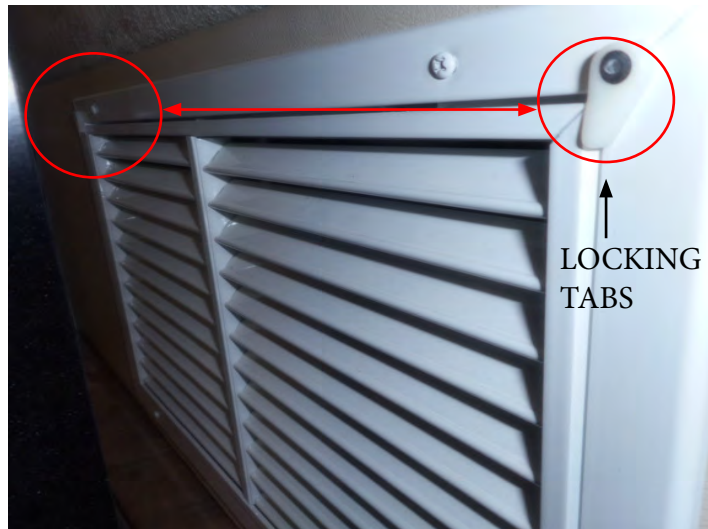

The starboard side air conditioning compressor and condenser units are accessed at the salon refrigerator. Remove the refrigerator to access the air conditioning compressor and condenser unit periodic maintenance. Ensure refrigerator breaker is deactivated before starting any maintenance procedures.



STARBOARD AC UNIT

The starboard side air conditioning return air filter is found at the aft vertical section of the sofa. Move the sliding glass doors as needed to access the return air filter. Move the 2 locking tabs to release the air return cover. At this point you will be able to remove the gray mesh filter. Clean with soap and water. Rinse dry and reinstall filter. Cover return air grille and lock with tabs. See photo below.

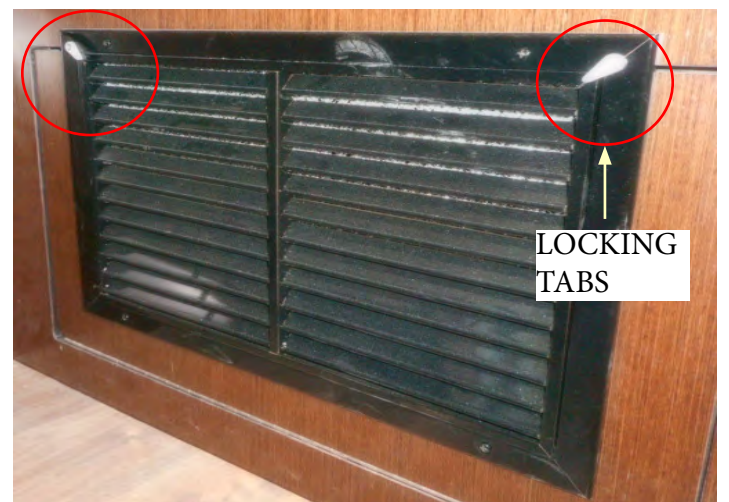



Reverse Heat

Your yacht air conditioning system features a reverse heat cycle. This can be extremely valuable to boater's in colder climates especially for early spring and late fall cruising. To accomplish reverse cycle heating, the R-22 refrigerant flows in the opposite direction through a reversing valve located on the evaporator/condenser unit. Heat is transferred from the seawater in the coil of the condenser to the R-22 refrigerant and then to the air as it is blown through the evaporator to the cabin. Obviously, the temperature of the seawater will effect the air conditioner efficiency.

The temperature variance for cooling efficiency is:

Up to 90 Degrees F. (32.2 Degrees C.)

The temperature variance for heating efficiency is:

Down to 40 Degrees F. (4.4 Degrees C.)

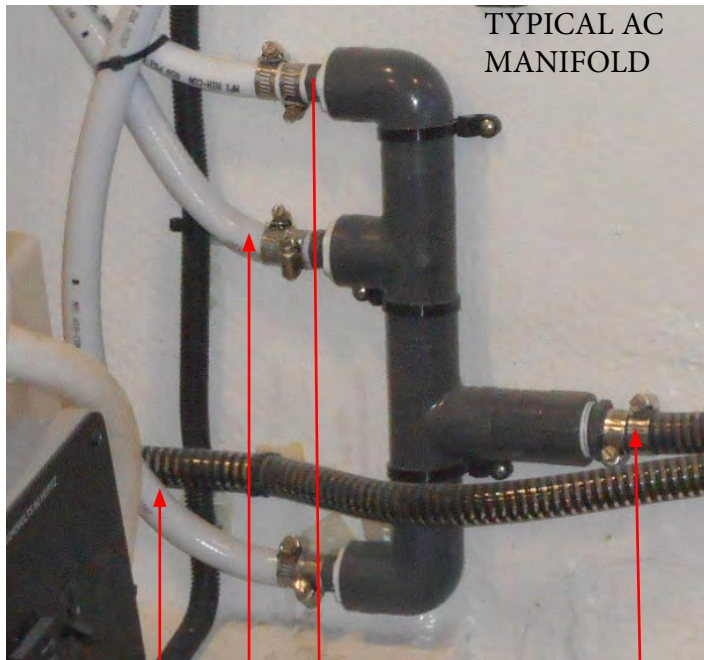

TO STBD
CABIN AC

TO PORT CABIN AC

TO FWD STATEROOM AC

FROM AC PUMP

Typical Air Conditioning System Operation

Below is a basic quick start-up checklist for the air conditioning system. For more in depth information, refer to the vendor operation manual found in the owner's documentation folder located in the port aft set of drawers in the aft master stateroom cabinet.

Operations Quick Start-Up Checklist:

1. Check the AC seawater strainer for debris.
2. Make sure the AC seawater pump seacock located in the engine room is opened completely (handle should be in-line with the hose).
3. Depending which air conditioning unit you desire to use activate that breaker on the yacht's main AC control panel.
4. Activate the air conditioner pump breaker located at the ship's main AC control panel.
5. Check the hull side for a steady stream of seawater. Seeing water here is normal when the AC pump is running. If stream is diminished or no water emits from the fitting immediately turn the AC pump off and investigate the cause of the problem.
5. Press the Elite thermostat Power button once to activate the air conditioning system. A blank screen displays when system is off and indicates present cabin temperature.
6. For cooling or heating press and release the Mode button until the desired LED is illuminated ie; automatic mode.
7. Press the Up or Down button to set the desired cabin temperature. To view the set point, momentarily press and release the Up or Down button.
8. Auto fan LED lights when Auto fan speed is selected.



TYPICAL ELITE AC CONTROL DIAGRAM

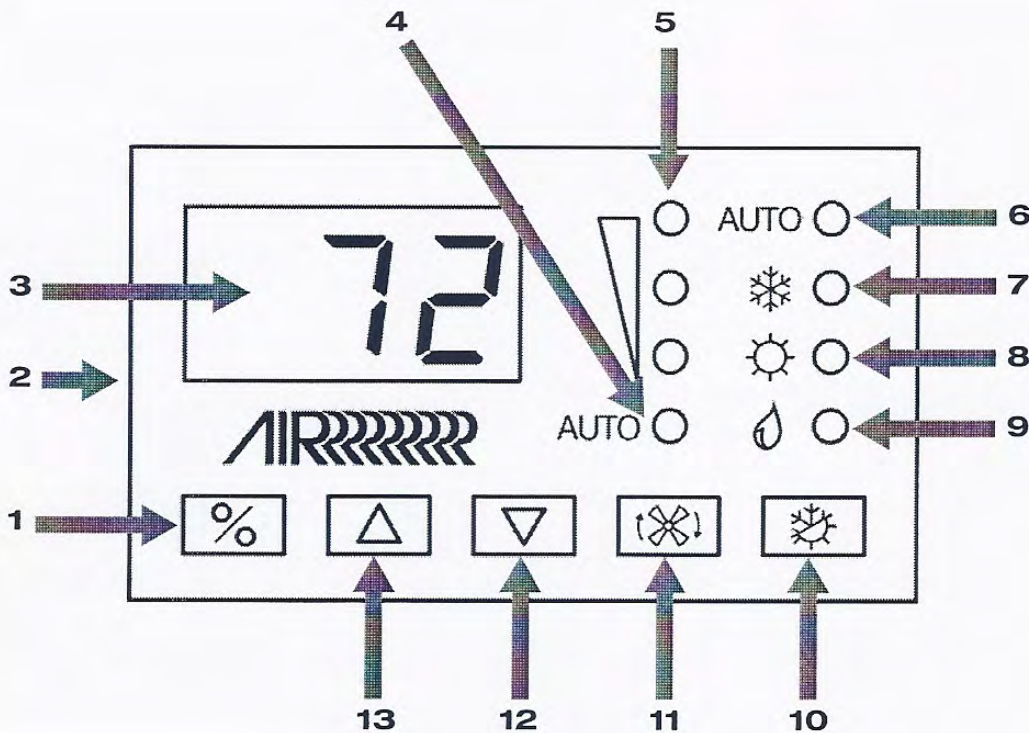

Elite Display - Diagram Legend

1	Power button	8	Heat Mode indicator
2	Temperature sensor	9	Moisture Mode indicator
3	Digital display	10	Mode button
4	Auto Fan indicator	11	Fan button
5	Manual Fan indicator (high, medium, low)	12	Down button - Lower temperature set point
6	Auto Mode indicator	13	Up button - Raise temperature set point
7	Cool Mode indicator		

Note: The Elite display continually monitors the system components. Should a problem develop it sends a diagnostic code to the control (thermostat) display. Refer to the vendor air conditioning manual (troubleshooting) to assist in identifying the problem.



TYPICAL A/C INSPECTION TIPS

Seawater Strainer

The air conditioner seawater strainer located in the engine room should be cleaned periodically of debris which can inhibit or stop the fresh seawater supply.

Always turn the seacock to the off position (90 degrees to the hose fitting) before cleaning a seawater strainer. Remove the basket by turning the plastic cap in a counterclockwise direction. Set the cap and the O ring aside. Pull the basket from the unit, rinse with water, air dry and reinstall. Sediment at the bottom can be removed by just turning the plug in a counterclockwise direction. Set the plug and O ring aside. Place a container under the strainer to catch the sediment. Coat the O rings with waterproof grease containing a silicone or teflon base. Reinstall O rings along with the plug and plastic cap. Turn on the seacock and check for leaks.

Return Air Filters

Once a month check the return air filter located on the face of each evaporator. To clean rinse with fresh water, air dry and reinstall.

	WARNING
PREVENT SEVERE INJURY OR DEATH! DISCONNECT ALL ELECTRICAL POWER SOURCES BEFORE ATTEMPTING TO OPEN, REPAIR OR REPLACE ANY AIR CONDITIONING COMPONENTS.	

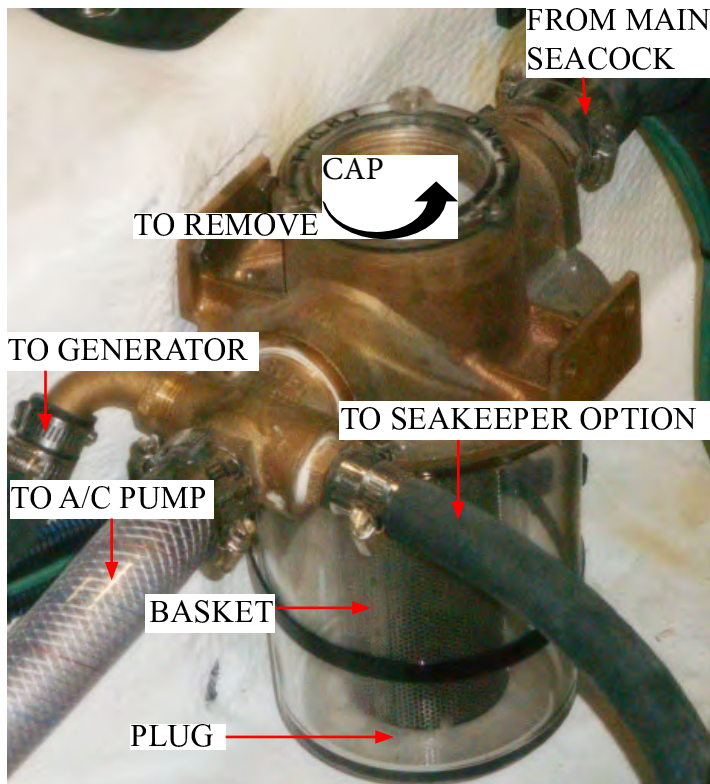

TYPICAL A/C SEAWATER STRAINER



Drain Pans

As noted on an earlier page the AC evaporator/condenser units feature a 2" deep drain pan connected by a hose that runs to a sump pump and eventually exits overboard. Periodically just like your home AC, the pan needs to be rinsed clean of debris and possible mold.

You can use a purchased product made specifically for cleaning AC units. Disconnect the outlet hose from the AC pan and install a made up hose (5/8") that will catch the used solution to fill a small container. Dispose of the container in accordance with federal, state and local regulations. Pour the solution into the pan and allow time for it to drain. Reconnect the original drain pan hose when finished.

Condenser Coil Cleaning

Periodically the condenser coils are recommended to be cleaned. This procedure should be done by a professional since an acid solution must be used and the condenser units must be accessed.

POSSIBLE PROBLEMS/SOLUTIONS (A/C)

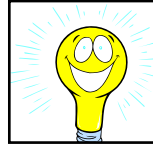

1. No or little water is noticed at the thru-hull fittings and a HPF shows on the display which means the high pressure switch is open.

The strainer or intake hose may be clogged, seacock may be closed or a hose may be collapsed or kinked. Check AC pump breaker to verify pump operation.

2. Air conditioner will not start. Ensure the proper AC breaker is actuated on the ship's main control panel.

3. No cooling or heating. Lower or raise set point on thermostat control to offset set point being satisfied. Check for obstructed seawater flow. Remove discharge side of pump hose to purge air (air-lock). Seawater temperature too high for cooling and too low for heating.

4. Fan coil is iced. Raise or lower control set point. Clean return air filter. Switch AC to heat until ice melts or as a last resort use a hair dryer to melt ice as needed.



TYPICAL FRESH WATER SYSTEM

Overview

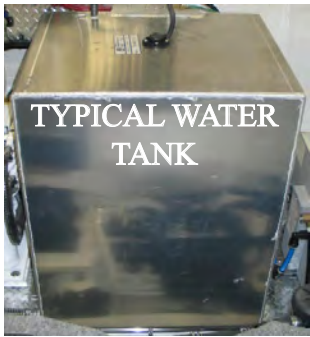

Your vessel is equipped with a fresh water supply referred to as a potable water system. It consists of fresh water tanks, dockside fill/vent fittings, monitor panel, pressure water pump with filter, distribution lines, manifolds, wash down spigots and hot water heater.



There are two options for using the ship's water supply.

At **mooring**, a hose approved for drinking water is connected to the dockside city water valve and the vessel uses marina water to supply the various faucets or

shower heads. These approved hoses feature a white color and are readily available at marina's, RV dealerships, marine speciality stores, and big box stores in 5/8" or 3/4" diameters. When connected to the dockside valve the system bypasses the ship's potable water system tanks if the main water supply manifold valve in the master head behind the teak shower panel is turned **off**. See illustration to the right.

Note that the shut-off valve is labeled starboard water tank since the water fills from the starboard to the port tank and is self-leveling during the filling process. As both tanks become full the excess water will run to the hull side vent overboard.

Remember at the end of the filling process to turn off the master shut-off valve or sourced water from the dockside valve will continue to run overboard through the hull side vent. Never leave the vessel unattended.

Check fresh water level periodically at the monitoring panel so you know the system filled status.



MASTER SHOWER TEAK LOCKER- FRESH WATER SYSTEM TANK SHUT-OFF VALVE INSIDE



TYPICAL FRESH WATER MANIFOLD WITH SUMP (BILGE) LOCATION

In addition to the starboard head fresh water manifold there is another fresh water manifold located in the sump. The photo insert shows the hot water side of the manifold depicted in the larger photo. Notice the shut off valves for the various components offering hot water capability such as the transom shower, galley, optional head shower, master head shower, and master vanity sink. These circuits are listed above from top to bottom per the illustration.

The skipper should be familiar with the fresh water manifold location and the various shut off valves in case of maintenance, plumbing emergencies or winterizing needs.





TYPICAL FRESH WATER MANIFOLD WITH SUMP (BILGE) LOCATION (CONTINUED)

As part of the fresh water manifold located in the sump the photo insert shows the cold water side of the manifold depicted in the larger photo. Notice the shut off valves for the various cold water components including the master head, galley, galley sink, icemaker and transom shower. These circuits are listed above from top to bottom per the illustration.

The skipper should be familiar with the fresh water manifold location and the various shut off valves in case of maintenance, plumbing emergencies or winterizing needs.





At Sea, using fresh water pressure pump system energize the fresh water pump breaker at the ship's main DC panel. This will permit water to flow through the tubing to the appropriate faucet or shower head.

Note: Remember that all fresh water at sea is being delivered through the on board potable water tank. Therefore, it is important to periodically check the fresh water monitor which senses the level of the water in the potable water tanks.

Opening each faucet for a few seconds will purge any air in the system especially in cases where the fresh water tank has run out of water. When water is running at a particular faucet it is not unusual to hear the water pump activate as it is trying to build up the pressure required in the system. Soon after the faucet is turned off the fresh water pump sound will end indicating the fresh water system is now up to specified system pressure.

Note: If the fresh water pressure pump continues to run long after the faucets are deactivated check for fresh water system leaks.

Note: Do not run pressure water pump with system dry as water pump component damage will occur.

Fresh Water Pressure Pump

In theory the fresh water pump system provides water pressure when dockside water is not available or used. Once energized the pump is automatic. It will shut down once system pressure has built up and will automatically start after a faucet is opened.

The fresh water pressure pump features a removable strainer basket filter which collects any debris which has entered the fresh water system. The clear strainer cover highlights any debris.

To clean the basket make sure the pressure water pump is off at the ship's DC control panel. Unscrew the clear cover to access the strainer basket. Remove the strainer basket, clean, rinse with fresh water and reinstall basket and cover. Do not overtighten or use tools. Turn on the pressure pump breaker and check for leaks.



TYPICAL FRESH WATER PUMP

Note: It is recommended that the fresh water pressure pump breaker be flipped to the "off" position when leaving your yacht to help prevent damage should a leak develop in the hot or cold water system.

WARNING

PREVENT PROPERTY DAMAGE!
DISCONNECT
THE DOCKSIDE WATER INLET HOSE
BEFORE LEAVING THE VESSEL.

NOTICE

TO PREVENT POSSIBLE WATER PUMP
IMPELLER DAMAGE DO NOT RUN
FRESH WATER PRESSURE PUMP
WITHOUT ANY WATER!



For general knowledge all red water tubing supplies the “hot” water on board your vessel. Likewise, all blue water tubing supplies the “cold” water.

Note that the system is normally winterized from the factory utilizing a product called “Freeze Ban”. It is best to completely drain the Freeze Ban before adding any water to the tank in order to minimize the taste of Freeze Ban. Freeze Ban will not harm you but it does have a peculiar taste.

The system requires little maintenance except occasional flushing of the tank, cleaning of the water filter and winterizing in cold weather climates.

For more specific information on the water system contact your closest Regal yacht dealer.

Note: To completely turn vessel water off:

1. At mooring with the standard dockside water inlet valve connected turn the marina faucet off. Disconnect the dockside water inlet hose. Reinstall the dockside water valve cap.
2. At sea deactivate the pressure water system breaker at the ship’s main DC electrical panel.

POSSIBLE PROBLEMS/SOLUTIONS- FRESH WATER SYSTEM

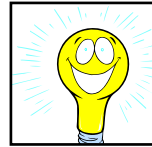

1. Fresh water pressure pump cycles on and off. Normally this type of action indicates a water leak in the system. Check all fresh water system related equipment on the deck, cabin, and engine compartment for leaks. Do not forget wash down equipment including spigots. Look for puddled or dripping water.
2. Using potable water system the water pressure is weak. Check the fresh water pressure pump filter for debris. Also, make sure the potable water tank level is sufficient at the salon monitor.
3. Water at sink or shower is hammering and has air bubbles in it. Check for air leaks in the system along with low water levels in the potable water tank.
4. Water is backing up in the shower. Find the correct shower sump pump. If it is full of water even when running there normally is a clog at the pump screen. Clean as needed.
5. There is no water at any of the fresh water related equipment such as faucets, showers and wash downs. Check to make sure the fresh water pressure pump breaker is on. Also, check the fresh water monitor for tank levels at the salon control panel.
6. The water system has a bad odor. Use the fresh water pressure pump to drain the fresh water system. Do not drink the water as it may be contaminated. Sanitize the water system as explained earlier in this chapter
7. There is no hot water. Turn the hot water heater breaker to the off position. Remove the back cover on the water heater and check the reset button. Push to reset. Also, the heating element may of malfunctioned. At this point, call a service technician.



Typical Transom Shower/Wash Down



If installed the transom shower is located at the starboard transom. It features a cold water sprayer with sufficient hose to rinse passengers entering from the water, etc.

Wash Down Faucets (Spigots, Silcocks)



If installed, washdown spigots are integrated into the on board potable fresh water system. To operate the spigot energize the pressure water breaker at the ship's 12

volt control panel. Fasten a garden hose to the spigot male fitting and one of the protective nozzles supplied to help prevent scratching the boat's surface. Open the spigot (cold water only).



WARNING

PREVENT INJURY AND PROPERTY DAMAGE
DUE TO FIRE OR ELECTRICAL SHOCK!
NEVER WASH DOWN ENGINE ROOM
ELECTRICAL COMPONENTS. WASH DOWN
HOSE IS FOR BILGE FLOOR
SURFACE USE ONLY.



WARNING

PREVENT PROPERTY DAMAGE!
DEACTIVATE THE FRESH WATER
PRESSURE PUMP BREAKER AND
DOCKSIDE WATER INLET HOSE BEFORE
LEAVING THE VESSEL.



Typical Forward Deck Wash Down



Under the forward deck locker is a wash down hose and faucet. To use make sure the fresh water breaker is energized on the ship's main DC panel, turn on the faucet, pull the hose assembly out of the storage cavity and adjust the hose nozzle to the needed spray pattern.



Typical Monitor Panel

The water system features a water/waste system monitor panel which senses the amount of water left in the potable water tank system. It is located at the ship's main AC-DC electrical control panel in the atrium.

To use the panel, press the switch in toward the freshwater tank position and hold. The amount of potable tank water will be displayed. The sender for the fresh water monitor is located on the top of the starboard fresh water tank which is located in the engine room. The key switch is used for overboard discharge. Read and understand the section on using the macerator in the waste system before attempting to operate the overboard discharge system. Laws in many locals prevent the use of overboard discharge. A person could be severely fined so know the restrictions before using the macerator pump-out.



TYPICAL WATER/WASTE MONITOR PANEL

NOTICE

DO NOT USE WASTE PUMP OUT
BEFORE KNOWING LAWS/REGULATIONS
REGARDING DUMPING WASTE

Sanitizing Water System

If the vessel has been in an extended storage condition or you suspect the water system may be contaminated, then the system should be sanitized.

You can purchase a water treatment kit with ingredients that will sanitize the system. Follow the directions with the treatment kit. If a water treatment kit is not available follow these steps to sanitize the water system.

1. Make sure the water tank is pumped until empty. Shut off the water pressure breaker at the 12 volt ship's panel.
2. You will need approximately one gallon of a reduced bleach solution per each 15 gallons of tank capacity.
3. Formulate the correct amount of reduced bleach solution by mixing 1/4 cup of unscented household chlorine bleach per gallon of water. Press the monitor panel water tank switch at the ship's control panel to determine the approximate number of gallons left in the water tank.
4. Pour the weakened bleach solution into the water tank. Again, use the formula of 1 gallon reduced bleach solution for every 15 gallons of tank capacity.
5. To further reduce the power of the bleach solution fill the remainder of the water tank with fresh, clean water.
6. At the ship's 12 volt control panel, "flip" the water pressure breaker to the "on" position. Turn on the faucets to purge any system air and to circulate the bleach solution to all areas. Now turn off the water pressure breaker.
7. Let the solution set in the system for 3-4 hours.
8. Pump the water tank until empty.
9. Fill the water tank full with fresh, clean water. Turn the faucets on a let the entire tank flush through the system..



Typical Hot Water Heater

Your yacht offers a hot water heater which is controlled by the generator at sea or shore power while at dockside. The hot water heater incorporates a drain valve to purge the system of mineral deposits. A reset button is found at the aft end of the component. See chapter 7 for further detailed information.

Read the water heater owner's manual to understand how to drain the water heater since element damage may occur if performed incorrectly.

 **WARNING**

TO PREVENT HOT WATER HEATER DAMAGE!
NEVER ACTIVATE THE BREAKER
WHEN THE HOT WATER HEATER
IS NOT COMPLETELY FULL OR
THE ELEMENT WILL BE DAMAGED!

Typical Shower Sump Pump System

Your yacht features a master and as an option aft shower. The head/shower water supply is controlled by the water system manifold.

As part of the drainage system a self-contained shower sump pump collects all water and debris. After the water reaches a predetermined level the float switch permits the pump to send the used shower water to the waste tank as a high velocity pump exits the water overboard from the head shower(s).

After showering, always let about one gallon of water settle through the shower drain to help rid the shower, drain, lines, and shower sump of debris, hair, and mineral deposits.

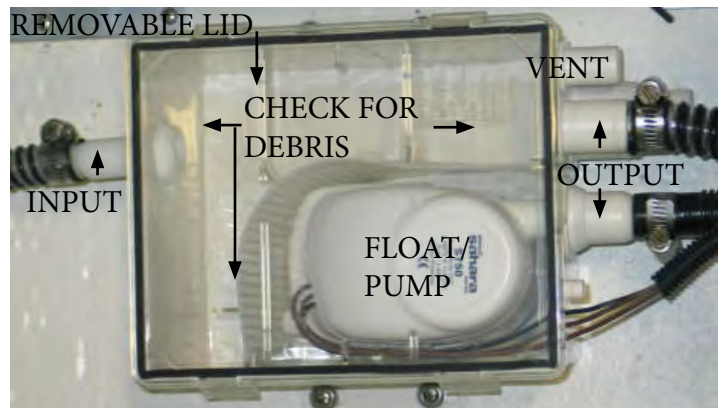

TYPICAL SHOWER SUMP PUMP

Refer to the sump shower hose identification diagram for specific hose routes found earlier in the air conditioner section.

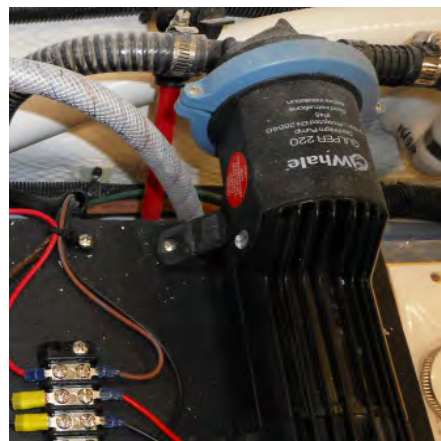

SHOWER PUMP (LOCATED IN ENGINE COMPARTMENT)



TYPICAL WASTE WATER SYSTEM

Overview

The waste water system on your vessel is located in the sump. Note on later yachts a metal tank provides waste storage. Besides the tank the system may feature two toilets and waste pump-out fitting mounted at the amidships deck. A monitor panel shared with the fresh water system displays the waste tank level when activated. If installed, a macerator (overboard discharge pump) diverts waste from the waste tank through a hull bottom seacock (where dumping laws permit).

Before activating seacock ensure the seacock is turned to the straight (in line with the valve) position. Not opening the seacock may cause pump damage or may on rare occasion cause an eruption.

WASTE TANK HOSE FUNCTION	
EQUIPMENT	FUNCTION
Pump Out	To Pump Out Deck Fitting
Vent	To In-Line Vent
Forward Head	From Forward Head
2ND. Head	From 2ND. Head
Overboard Discharge	To Macerator (Overboard Discharge Pump) Located In Engine Room
Gray water OPT.	From Shower Sump Pumps

NOTICE

AFTER OVERBOARD DISCHARGE TURN SEACOCK VALVE TO THE "OFF" OR CLOSED POSITION, AND RE-TIEWRAP ARM TO AVOID POSSIBLE FINES.

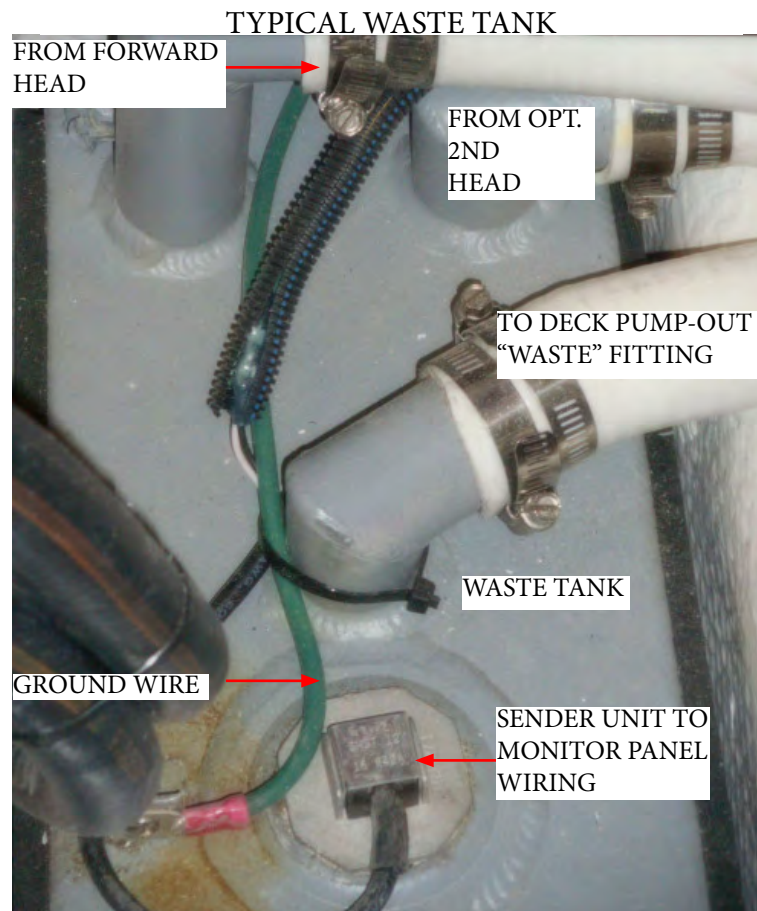



Gray Water System

If installed, the gray water system is used in areas where dumping fresh water waste products overboard is prohibited. Gray water originates from onboard sinks and showers. With this system all the gray water is pumped into the waste holding tank via the shower sump pump system versus directly overboard. The holding tank periodically needs be to be pumped out by a marina pump out station through the “waste” fitting on the starboard deck. Use the waste water portion of the monitoring panel at the ship’s main control panel to check waste water levels.



Typical Head (Toilet) System

The onboard style head system features a vacuum toilet using minimal water. It normally features vitreous china bowls, minimal maintenance, easy cleaning and a wall switch keyboard. Note that aft head is optional.

The toilet is powered by 12 volt DC electricity and is controlled by forward and optional aft head 30 amp breakers located at the ship's main salon control panel. Under normal conditions, the head system operates from the onboard freshwater tank. If dockside water is being used the toilets still draw water from the freshwater tank.

A Few Notations About Marine Toilets

Only human waste and toilet paper should be put in the toilet. Never flush foreign materials such as paper towels, pre-moistened wipes, condoms, feminine hygiene products, dental floss or household garbage down the toilet.

- Always disconnect the dockside water system if boat is left unattended to avoid property damage due to leakage.
- Refill the toilet as soon as possible after emptying the bowl to prevent objectionable odors.
- Use only RV-Marine toilet tissues that disintegrate rapidly. Do not use household type tissues.
- If repairs are needed, use only a trained and qualified marine technician or electrician.



Typical Head w/ Vacuum Toilet & Vessel Sink



Using Vacuum Style Toilet-

To use the on board toilet(s) first make sure the 12 volt breaker is activated at the main control panel. Remember even though you are using dockside water the heads draw water via the fresh water system through the potable water tank.



The wall control switch is used to add water to the bowl and to flush the toilet. Select cycle information is noted below. For more complete information, refer to the toilet vendor information located in the information packet.

1. To add water (est. 17 ounces each cycle) to the bowl press the add water button momentarily and release. The system prevents overfilling the bowl.
2. To flush the bowl press the flush button momentarily and release. The attached bowl motor will macerate the waste and flush it. The cycle ends with a small amount of water being added to the bowl to help prevent odors. This completes the minimal water usage flush cycle.

Wall Control Panel Blue Backlighting Description:

- The holding tank icon in the lower right hand corner of the control panel is not lighted. Toilet system is off or not receiving power.
- The holding tank icon is normally green. This means the holding tank is less than full.
- The holding tank icon is red. The holding tank is full or near full with the flush lockout (prevents Flush operation when holding tank is full) activated.
- Tank icon flashes
- Sleep mode (non-use for 8 hours) causes the lights to go out. Pushing the fill or flush button momentarily will return lighting cycle.

Single Flush Override of Flush Lockout

1. If the holding tank is full the flush lockout cycle will not allow the bowl to be flushed and the flush button will be lighted red.
2. For emergency use only the flush button can be held for 8 seconds and a flush will occur. This can be accomplished because the full sensor connected to the holding tank is usually placed a bit below the actual full capacity of the tank. Flushing more than 5 times using the override feature may force waste into plumbing system. Regal is not responsible for damage to equipment, or injury or death due to overflow of waste due when flush lockout is overridden. Again, refer to toilet vendor information in the owner's information packet.

 **CAUTION**

POSSIBLE OVERFLOWING
OF THE WASTE HOLDING TANK
CAN OCCUR DUE TO USING
THE SINGLE FLUSH OVER-RIDE FUNCTION.
FOR EMERGENCY USE ONLY.



Typical Dockside Pump-Out



There is a fitting located on the deck labeled “waste.” This fitting is used to pump out the waste tank. Normally a pump out station service is available at most marinas.

After removing the fitting cover a special hose is inserted into the fitting and the machine then removes the waste. Normally there is a charge for the service. Make sure they connect the hose to the “waste” fitting. Of course when cruising in international waters the overboard discharge pump may be used. See the section on using the macerator.



There is a waste filter installed in the vent line between the waste tank and a thru-hull fitting. The filter’s purpose is to keep objectionable odors to a minimum from the waste tank. It is recommended that the filter be changed yearly. It can be ordered from your Regal yacht dealer or from marine supply stores. Typically the waste filter is mounted in the sump (engine compartment). Note that the filter exits through a transom fitting near the starboard swim platform area.

One union fitting on each end make it easier to change out the filter.



Typical Macerator (Overboard Discharge Pump Use)



The macerator (overboard discharge pump) option is located in the engine room. It is connected to a normally closed seacock. In locals where it is approved the seacock is opened and

the macerator is activated through a key switch and button located at the ship's main salon control panel (shown above). At that point waste travels from the waste holding tank through the macerator pump where it is ground up and then exits through the hull bottom at the open seacock. See the photo.

To Use Macerator (If Installed):

- Make sure it is legal to pump waste overboard before starting the operation.
- Locate the overboard discharge seacock in the engine room. Usually this seacock can be identified by the stack of tie wraps next to it. Also, look for the incoming hose that runs from the output side of the macerator to the seacock. It is normally a 1 1/2" diameter white hose. Since the seacock by law must have another means besides the handle to keep it closed the tie wrap serves that need. Cut the tie wrap to access the seacock handle.

HOSE FROM
MACERATOR

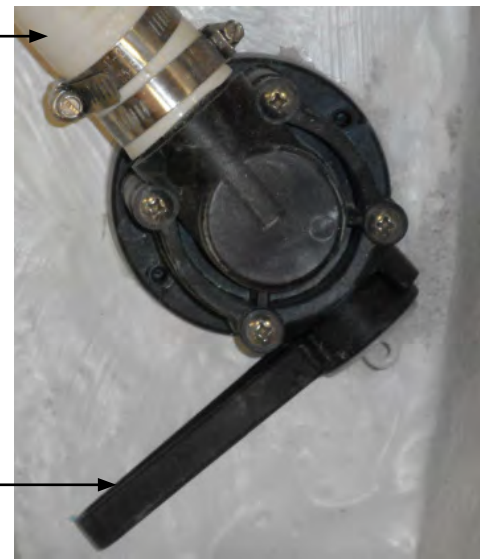

SEACOCK IN
CLOSED
POSITION

MACERATOR SEACOCK

- Open the seacock handle. It should be positioned in line with the seacock. Activate the macerator breaker at the 12 volt salon main DC control panel.



- At the level monitor panel shown above turn the key to the "on" position. With the key switch being held the "on" position push in on the macerator button to start the overboard discharge. Continue to discharge the waste until the monitor panel shows empty for the waste tank. At this point, shut off the macerator switch, deactivate key switch and turn macerator breaker to the "off" position.

Close the seacock handle. It should now be at a 90 degree angle to the seacock.



- Use a tie wrap and refasten the seacock handle tightly so it can not be moved.



- At this point you may desire to add an approved holding tank deodorant by flushing the correct amount down the toilet.



POSSIBLE PROBLEMS/SOLUTIONS- WASTE SYSTEM-



1. Toilet does not flush or flushing performance is poor. The holding tank indicator is lighted red at the toilet control panel wall switch. The holding tank is full and needs to be pumped out. Also, there could be a clog at the water pump inlet.

2. No water in bowls during flush or add water cycle. Check to make sure the main water supply has not been turned off along with the fresh water pressure pump.

3. There is no light on the toilet wall control panel or it does not stay lighted. Check the head breaker on the main ship's control panel. Also, the wall panel could of entered the Sleep mode cycle after 8 hours of inactivity.

4. There is an odor of sewage onboard. Check the vent filter. It should be replaced annually at the beginning of the boating season. Also, check the waste tank, fittings, and related hoses throughout the vessel.

5. When running the overboard discharge pump is not pumping out the waste. Check to make sure the deck waste cap is securely fastened and O ring is not missing.



TYPICAL VACUUM STYLE TOILET WASTE SYSTEM

1. Toilet Bowl
2. Solenoid Valve
3. Fresh Water Pressure Pump
4. System Vent
5. Holding Tank
6. Fresh Water Tank (System can also run from dock-side water supply)

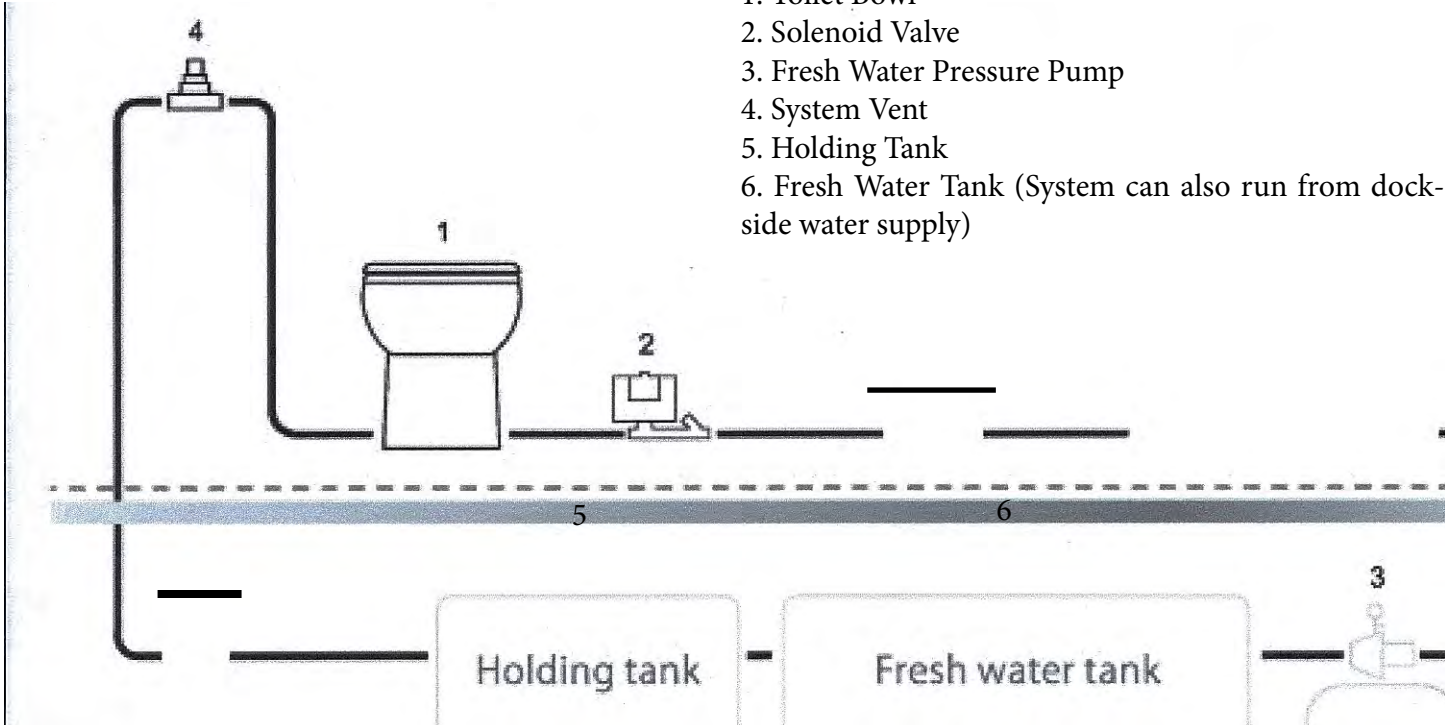

Electric Diagram

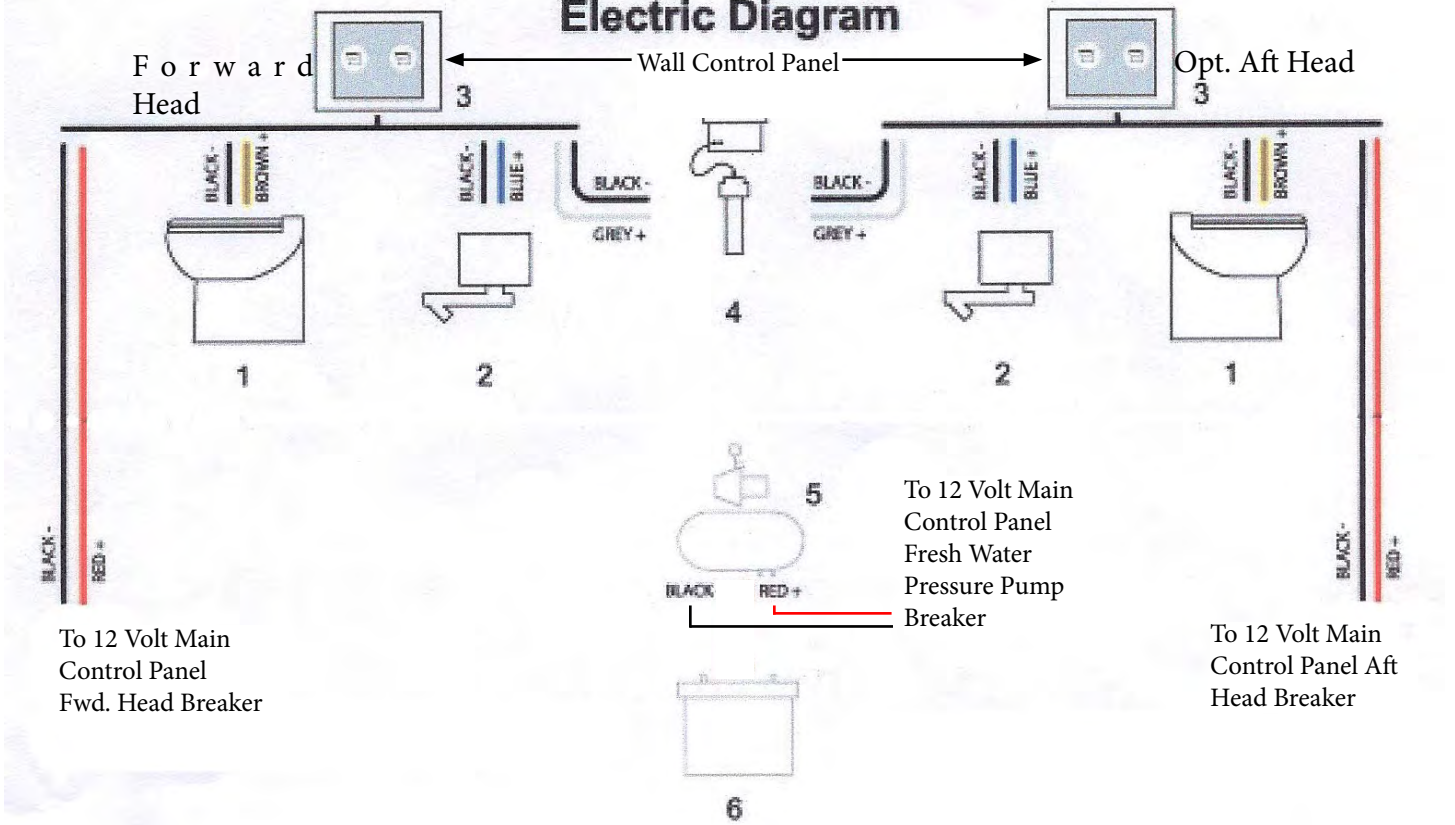



TRIM TABS

Trim tabs are installed on the lower hull at the transom area. Water is deflected and redirected as the trim tabs are raised and lowered from the dash switches. This change in water flow creates upper pressure under the tabs, and raises the stern. When the stern rises, the bow is lowered. Lowering the port tab will cause the port stern to rise, making the starboard bow lower. Lowering the starboard tab will cause the starboard stern to rise, making the port bow lower.

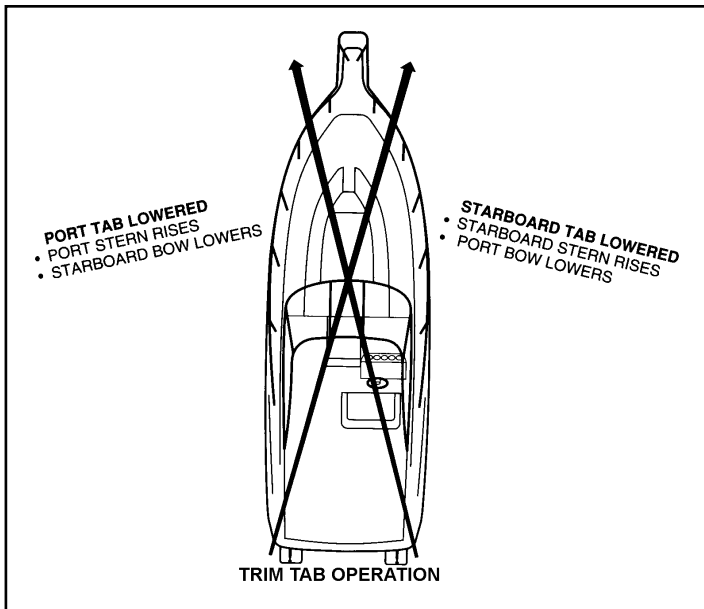

Using trim tabs will compensate for uneven weight distribution, listing, water conditions, wind velocity and other factors that cause inefficient operation.

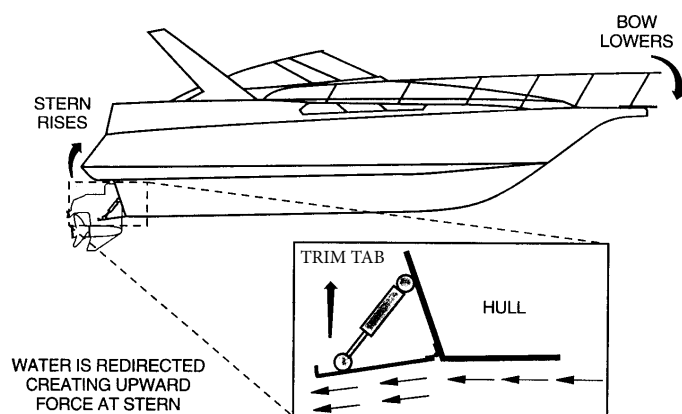

AUTO TRIM DASH SWITCH



Obtaining A Trimmed Position-Manual Operation

Your Regal yacht reaches a planing position at a designated speed. This speed is determined by bottom design, weight distribution, water conditions, and on board equipment. As the throttle is advanced the stern squats and the bow rises initially. The trim tabs allow your boat to plane at a slower speed than natural conditions allow.

In short bursts push both trim tab rocker switches simultaneously in the “bow down” position which causes the trim tabs to move down. As the boat breaks over the bow high attitude the boat speed accelerates and visibility increases. The LED indicators will show you relative position of both tabs and the LED light intensity can be adjusted.

If the boat is over trimmed, it will plow the bow and the boat will lose maneuverability. If this occurs, simply short burst the “bow up” trim tab rocker switches simultaneously.



In the “learning curve” process, press the tab switches in half second bursts. You will notice a slight delay from the time the switches are pushed until the boat reacts depending on vessel speed. You will know after awhile the optimum planing angle and speed.

When running in heavy seas press the “bow down” position which will assist the vessel to cut through the waves. This will produce a drier and more comfortable ride.

When trimmed or in the bow down position, the bow spray is farther forward, the wake is smaller, and positioned further behind the vessel. Also, when trimmed you will notice that the tachometers show an increase in rpm’s. In addition, there is an automatic override position. For more information refer to the trim tab owner’s manual.

Obtaining A Trimmed Position-Auto Mode

By using the 2 favorite mode buttons you can store 2 favorite automatic running attitudes in memory. Refer to the trim tab owner’s manual for real-time Auto Trim Pro adjustments with LED indication. The system even adjusts to side to side running situations such as wind and waves.

Rectifying A List

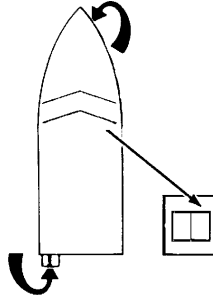

Your vessel can use the trim tabs to rectify a list. The trim tabs adjust the boat’s attitude in the direction the helm rocker switch is pushed.

If the port bow is high, push the left-hand “bow down” direction on the dash rocker and the port bow will lower. If the starboard bow is high, push the right-hand “bow down” direction and the starboard bow is lowered.

Porpoising

Porpoising is a running condition where the bow “bounces” up and down similar to a porpoise motion. Press “bow down” in one-half second bursts. As the trim tabs turn, the porpoising should recede and the vessel speed should increase. Only a small amount of “bow down” is normally necessary to make this change.



TYPICAL WINDLASS

INTRODUCTION

Using the anchor windlass requires knowledge of the anchoring process to understand the correct amount of rode and scope required. Read the section on anchoring, the windlass operation manual and understand all safety information before attempting to run the windlass. Also, since anchoring is one of the skills the skipper should master for cruising “peace of mind” visit your local library or “surf” the internet to locate further information regarding anchoring techniques.

WINDLASS SAFETY TIPS & WARNINGS

- Never use the windlass to tow or pull a boat.
- Never use the windlass for securing the anchor line. Instead use a deck cleat.
- Never drop anchor in the vicinity of divers or swimmers.
- Never wrap chain around the drum.
- Never use the windlass to pull up a person.
- Never use windlass to break anchor loose.

- Always strive under normal conditions for a 7:1scope ratio on the anchor line.
- Always remove the handle from the gipsy when operating windlass from the foot controls.
- Always turn the windlass deck switch to the “off” position when not in use.
- Always secure the anchor chain lock in “locked” position in foul weather.
- Always keep an eye on the rope/chain locker to avoid rope buiding up under the hatch.
- Always manage the retrieval process carefully to prevent the anchor from hitting the boat.

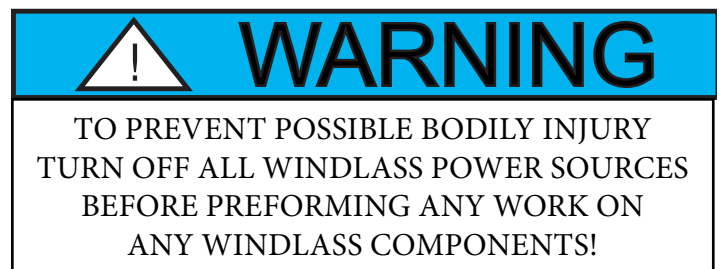

WINDLASS ANCHOR LINE

Although several variations exist the windlass is normally outfitted with 3/4 “ twisted nylon line and 7/16” chain. With this combination the vessel meets normal working load conditions and the rope/chain combination protects the rode. The heavier chain lowers the angle of pull and helps bury the plow anchor which increases the holding power.

When the plow anchor is buried the chain is protected from bottom chafing as the vessel is moved around due to current, waves and wind conditions.

Several methods of securing the anchor to rode are used today including eye splices, thimbles and shackles. Regal uses a set of hexagon threaded pins which are lock tightened in place. This method provides a clean finish and prevents loosening due to vibration. The bolts may be removed when necessary by using a hex fitting on a ratchet wrench.

The plow anchor featured on your Regal yacht has demonstrated to be efficient in a variety of sea bottoms. Experts say the verdict is still out on a grassy bottom but unfortunately some grasses or weeds resist penetration by any anchor.



TYPICAL WINDLASS OVERVIEW



WINDLASS COMPONENTS

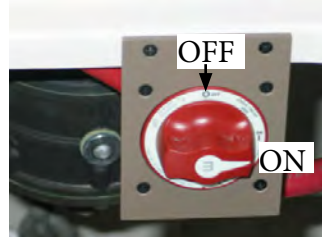

SWITCH SHOWN IN "ON" POSITION

The windlass is used to automatically raise and lower the anchor. Before attempting to lower the rope/chain rode check the rope locker for tangled rope or chain. Remove the safety lanyard from the anchor chain.

As seen in the illustration above open the deck locker to gain access to the windlass switch. The switch "off" position is at 12 o'clock. With the switch "on" position (shown above) at 3 o'clock the foot switches are energized.

After the anchor is let go and it is set properly with the correct amount of line payed out tie the rope securely to the anchor cleat shown in the illustration. Make sure it goes through the deck chock system. If needed use plastic tubing to protect the line where chock abrasion is a factor.

The entire anchoring system including windlass need to be maintained on at least annual basis. Refer to your windlass owner's manual for further information.

Note that the recommended rode for your vessel is a minimum of 300 feet with 1/2" rode and 3/8" chain.

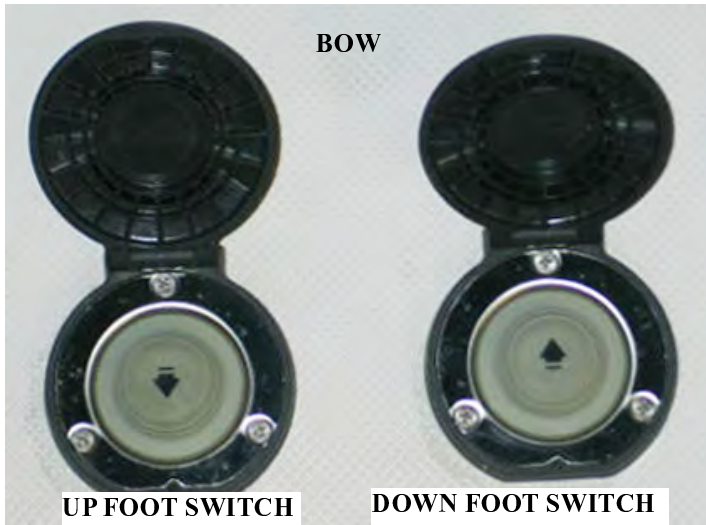

TYPICAL WINDLASS OPERATION

Paying Out Anchor

1. Ensure both the battery switch at the battery management panel and deck foot switch are energized.
2. Check the anchor rope locker for proper anchor line alignment. Untangle any crossed lines.
3. Check the proposed anchoring area for swimmers or divers.
4. Position vessel at proposed anchor drop site.
5. Check that pawl is in disengaged position.
6. Make sure chain stopper is in a released position.
7. Step on the down foot switch to pay out the chain and anchor line. When the anchor hits the sea bottom disengage the foot switch.
8. While the captain “bumps” the vessel in slow speed reverse pay out the anchor line until the correct scope is reached.
9. When scope is reached secure the anchor line around a cleat. Never use the windlass as the sole means of holding the anchor.
10. Check the anchor position by checking the position using the GPS. The GPS features an anchor alarm. Refer to the GPS owner’s manual for further information.

On select models bow foot switches are used to control the windlass. To use the foot switches remove the protective caps. When you energize the up foot switch the anchor is retrieved. When you energize the down foot switch the anchor is paid out. After the anchoring process is completed close the protective caps.



Retrieving Anchor

1. Check the anchor locker for any tangled lines.
2. Ensure both the battery switch at the battery management panel and deck foot switch are energized.
3. Undo the anchor line at the cleat.
4. Step on the up foot switch to retrieve anchor line as the captain “bumps” the vessel toward the anchor while maintaining a relatively straight anchor line position. Note: Breaker may blow if the captain does not bump the engines in gear due to the pressure on the windlass.
5. Once the vessel is over the anchor and it is broke free continue to retrieve the anchor. Check the anchor locker for tangled line and sweep the looped line out of the way if locker is filling up with line.
6. Once the anchor is approaching the bow slow down the windlass to ensure proper entrance at the chute and to avoid hitting the bow.
7. Once the anchor is completely retrieved “bump” the down foot switch to lock the chain.
8. As soon as possible after the cruise use the bow locker washdown to rinse off the anchor, chain and line. Coil the line on deck to air dry. This will aid in preventing mildew and salt deposit build-up.

Independent Warring

Once the primary rode is secure the drum can be used for docking or an additional rope only rode. To use this feature:



TYPICAL WINDLASS

- Make sure the chain lanyard is secured.
 - Make sure pawl is disengaged.
 - Disengage clutch by inserting the winch handle (mounted in deck locker) in top nut and turn counter-clockwise 1/2 a turn.
 - Remove handle and store in its designated location.
- The drum will operate independently from the gipsy.
 - When finished using drum, insert winch handle in top nut and turn clockwise 1/2 turn to re-engage clutch.



Manual Free Fall

The anchor can be dropped without the use of battery power with this feature.

To use:

- Check that pawl is in disengaged position.
- Release the chain stopper.
- Insert winch handle in top nut. Loosen top nut by turning counter-clockwise until anchor drops.
- Control the rate of fall with handle.
- Once paid out fully tighten top nut.

To avoid possible bodily injury and/or property damage read and understand the windlass operation manual before attempting to use the windlass or anchor components.

TYPICAL WINDLASS SYSTEM OVERVIEW

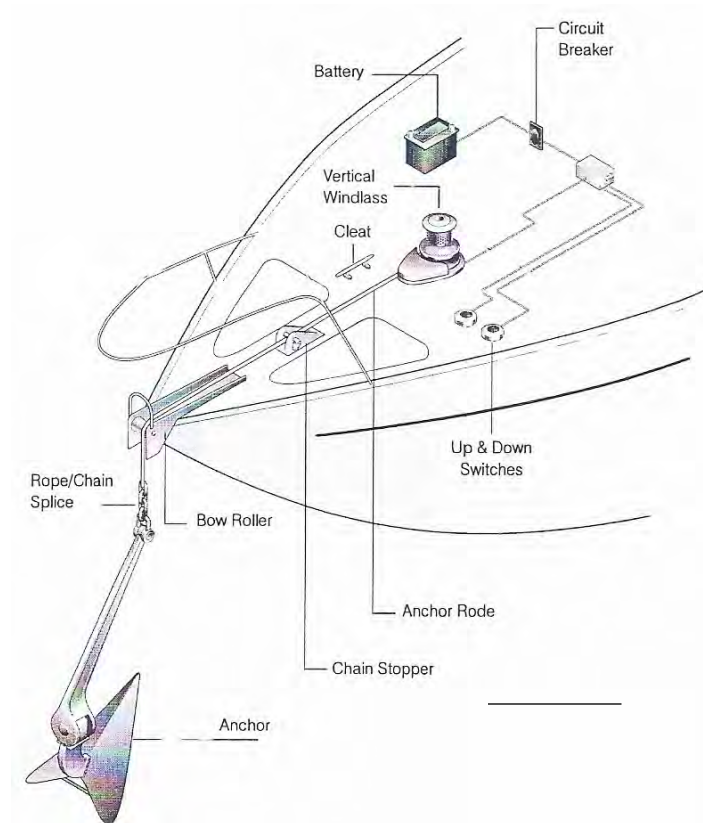

TYPICAL WINDLASS-SAFETY WARNINGS

- ◆ Ensure that limbs, fingers, hair and clothing are kept clear of the windlass and anchor during operation.
- ◆ Check to see that there are no swimmers or divers nearby before dropping the anchor.
- ◆ Remove the handle from the gipsy when operating the windlass from the foot controls or helm switch power.
- ◆ Always turn the windlass power supply to the “off” position when not in use.
- ◆ While at anchor, the load on the chain/rope must be transferred to a cleat.
- ◆ Do not use a windlass as a holding device for towing.
- ◆ Never use a windlass to lift a person, boat, etc.
- ◆ Check to make sure the permit switch is locked when the windlass is not in use.
- ◆ Remove the anchor safety lanyard before powering up the windlass.
- ◆ Fasten the anchor safety lanyard immediately after the anchor is positioned at the bow.
- ◆ Do not attempt to pull a load greater than the rated load of the windlass.
- ◆ Always use the vessel’s engines to aid anchor recovery.
- ◆ Refer the the windlass manufacturer’s owner manual for more detailed operating and maintenance information.



TYPICAL ENTERTAINMENT SYSTEM

OVERVIEW

Your yacht features a variety of standard components that provide both visual and audio entertainment. In addition, there are optional systems that are noted in the following pages. Regal reserves the right to delete, add, or change both standard and optional components at anytime without notice.

Note: The information found in the following pages is for current models only.

Please refer to the individual owner's manuals and the technical section (schematics) for further entertainment system information.

Preparing To Use Entertainment System-Breakers

Before using any portion of the entertainment system it is necessary to activate the 12 volt "house" battery switch located under the cockpit stbd. cushion. In addition, the generator (at sea) or the dockside cord (at mooring) must be activated/plugged in to supply AC voltage for the TV monitors.

In addition, depending on the entertainment component desired the following breakers may need to be activated:

12 Volt Breakers- TV Antenna, Satellite TV (controls dish), Stereo

120 Volt Breakers- Entertainment (controls stateroom TV's), Satellite TV (controls receiver)

Antenna Switch

The antenna switch features 2 buttons labeled A and B to choose the desired antenna signal source. It is located at the atrium AC-DC panel. See the salon entertainment system layout on the following page.

Note: Activate the TV antenna breaker. Follow the instructions below.

At Dockside- After the television coaxial cable is plugged into the vessel coaxial receptacle and the marina dock box press the A antenna switch button completely in until it catches. At this point the marina TV signal is available to view onboard televisions.

At Sea- Press the B antenna switch button completely in until it catches to activate the saucer-shaped television antenna mounted on the hardtop.

To deactivate either antenna switch, push the switch completely in; then release.

When cruising you may encounter a marina without a working shore signal so your backup is to use the ship's antenna. This is more common with older marinas located off the more traveled waterways.

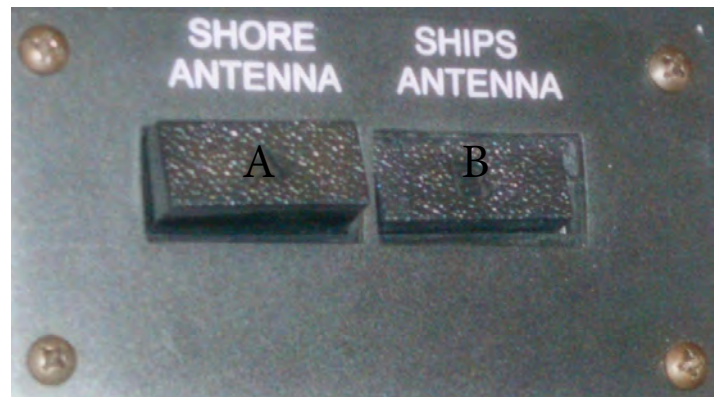

A/B ANTENNA SWITCH



TYPICAL TELEVISION/BLU-RAY PLAYER

Regal boats feature HD flat screen television monitors along with a Blu-Ray player which features DVD playback capability on all TV sets simultaneously through a splitter system.

Only the main salon TV has the potential to show the starboard glass cockpit screen information.

POSSIBLE PROBLEMS/SOLUTIONS



1. TV channels using the master remote control are sluggish to change or will not change up or down.

Change out the remote control batteries.

2. After a cruise and hooking up coaxial cable to the dock box the on board television sets do not display a picture.

Check to make sure the A/B switch is in the shore position.

3. The Fusion cockpit stereo does not play with the salon television on.

The salon television must be in the “off” position for the cockpit stereo audio to be heard through the salon entertainment system speakers.



TYPICAL SATELLITE TV



If installed, the satellite television option typically features the ability to viewing hundreds of television channels using the salon TV. Basically, the signal is transmitted through an antenna system installed on the hardtop which features a satellite tracking system that automatically finds the satellite for crystal-clear television reception. To activate satellite television a subscription must be secured. For more information call 1-800-970-9623

System Components-Antenna

The antenna uses modern technology to quickly acquire and track the correct satellite, switch between satellites, and send signals to the interface box. Internal gyros allow the antenna to track the satellite at all times, even with the vessel on the move!

Interface Box-Controller

The interface box supplies power to the antenna system and delivers satellite TV signals to the satellite receiver. This component is also used to set-up the LCD display.

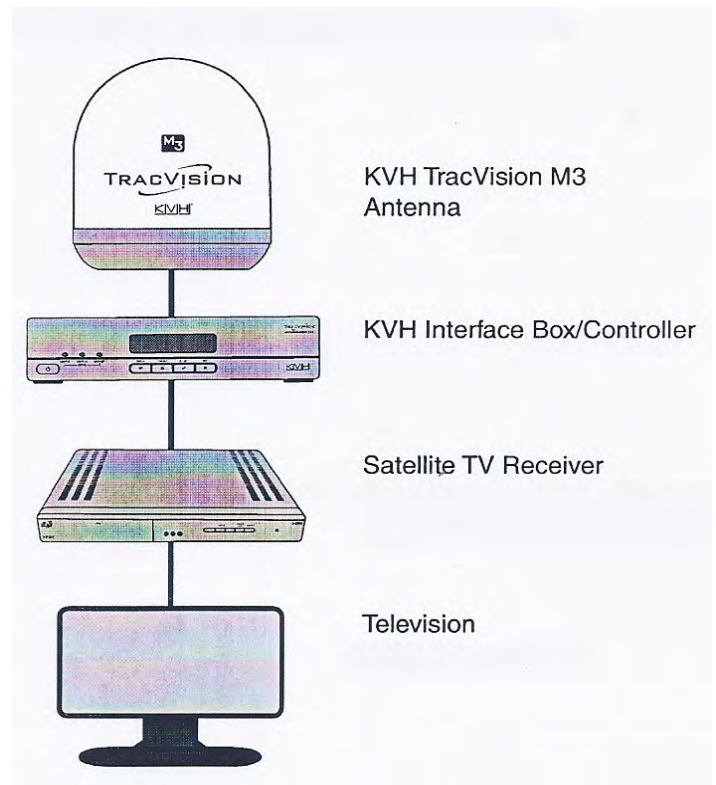

Television Receiver

The Dish network receiver has been chosen because of its compatibility with the KVH components. This unit receives HD (high definition) signals from 3 DISH network satellites. The antenna then switches between these 3 satellites as needed as you change channels using the Bose master remote control.

Television

The salon television delivers true high definition reception and is multi-functional with other entertainment components..

The satellite television operation is user friendly. Refer to the satellite television owner's manual for more information.



TYPICAL STEREO

Regal boats feature Fusion® marine stereo audio systems. Fusion stereo systems are designed and engineered to perform to the highest standards in the harsh marine environment. The head units feature easy to read displays and use oversized rubber buttons and controls for easier operation on a moving vessel. All components including the speakers comply with the international IP waterproof standards. Selected optional system components include an amplifier and additional speakers.

The unit features a UNI-DOCK for safe charging and playback of the latest Apple iOS and MTP Android/Windows media devices. Also, the units feature Bluetooth A2DP audio streaming capabilities, Pandora radio and NMEA 2000 conductivity.

The system utilizes a 15 amp automotive style fuse located behind the stereo head unit.

See the Fusion owner's manual for additional information.

SIRIUS XM SATELLITE RADIO

With the optional satellite tuner installed and a subscription you may be able to program and preset Sirius XM radio channels through the "Glass Cockpit" chartplotter. Use the MEDIA tab.

Before the subscription can be activated you must have the radio ID of the Sirius SM Connect Tuner.

It is located the ID on the back of the SiriusXM Connect Tuner. For more information you can call 1-866-635-2349 domestically.



Select vessel televisions can receive the stereo sound either through using the stereo head unit at the helm seat locker or can be controlled by the glass cockpit.

See the stereo manual or the glass cockpit manual as integrated in the helm units. To find the glass cockpit operation manual open it through the plotter as you would the Regal owner's manual.



VOLVO GLASS COCKPIT

The “Glass Cockpit” system on your vessel features a plotter integrating a single 16” screen. On select vessels dual 12” screens may be installed.

These systems offer one stop shopping for full overviews of navigation and engine data based on the Volvo Electronic Vessel Control platform abbreviated (EVC) which is an integral part of the Volvo Inboard Propulsion System (IPS). The Glass Cockpit monitors and controls all driver information including: navigation, engine data, and warning features in a single location.

The Glass Cockpit features:

- Multi-touch controls ie; (Pinch-to-Zoom)
- Both BlueChart g2 and LakeVu HD Maps
- Fully integrated with Volvo EVC system
- 10 X per second position/heading refreshment
- View and control from smartphone or tablet
- Glass cockpit look; flush mounting
- Integrated Glass Cockpit Owner’s Manual

Activating Glass Cockpit Plotter

To activate the Glass Cockpit plotter check the following:

1. Turn on the “house” battery switch located under the starboard cockpit cushion storage.
2. Energize the glass cockpit plotter power button at the top of the unit. Make sure power button is depressed long enough to power unit up.

Note that the electronics helm switch does not need to be activated for the Glass Cockpit unit(s) to work.

Locating Owner’s Manuals via Glass Cockpit Plotter

Your vessel is shipped from the Regal factory with a Regal owner’s manual integrated into an SDHC card. It may be found in the owner’s information packet. When activated by the Glass Cockpit chartplotter the manual can be opened to the chapter/page desired.

To use the Regal owner’s manual perform the following steps.:

1. Energize the chartplotter (power button) and wait for the home screen to appear.
2. After flipping up the cover, insert the SDHC card. Regal owner’s manual card into one of the 2 slots at the lower right corner of the plotter.
3. Touch the INFO tab at the screen bottom,.
4. Touch NEXT PAGE bar at the right screen area.
5. OWNER’S MANUAL bar will appear at the right screen area. Press owner’s manual bar.
6. The Regal owner’s manual title will appear as a main header bar along with the glass cockpit manual. Choose the Regal owner’s manual.
7. Touch the OPEN bar at the right screen area. The Regal manual will open to the title page (first page).
8. Touch the MENU tab. Choose TABLE OF CONTENTS at the right side under Document Menu. Choose a chapter to open.
9. At this point touch GO TO in the right screen area and you will be taken to the first page of the chapter chosen. Then you can use the arrows to go forward or backward inside the chapter along with being able to the size of the text (%).



TYPICAL VOLVO GLASS COCKPIT



GLASS COCKPIT PLOTTER
POWER ON/OFF BUTTON

EVC WIRELESS CONTROL

JOY STICK
FOR DOCKING



TYPICAL ELECTRONICS OVERVIEW

Your electronics package may include chartplotters, heavy duty closed-array radar, auto pilot, sonar with full-featured depth sounder functions, VHF radio with DSC capability and XM satellite weather radio.

A portion of the components are optional and may not be installed on your yacht.

Please refer to each vendors owner's manual for in-depth information regarding individual electronic components.

Regal reserves the right to upgrade, change, modify, or eliminate any system or component at anytime.

System Operation Overview

To operate the electronics the following switches need to be activated:

1. Make sure the battery switch located inside the starboard stairway locker is activated. To perform this function turn the "house" battery switch to the "on" position as shown by the arrow in the illustration.
2. Activate the "electronics" switch at the helm panel which controls power to the GPS antenna and the auto pilot.
3. At this point each individual component can be activated.

Refer to the illustrations for further information.



Electronics: Helm Switch

Notice the electronics switch as shown above. If the electronics group does not power up, check to ensure this switch is activated. Always find the source of a tripped breaker problem before reactivating it. Press the breaker in to reset it. Note that what ever components operate from this switch depends on each vessel's electronics options installed.



TYPICAL NMEA 2000 NETWORK

A NEMA 2000 network is made up of connected NMEA devices that communicate using basic plug and play functions. Regal uses a NEMA 2000 network to communicate with the Garmin electronics offered on your vessel.

A backbone assembly of T connectors, drop cables, power cables, male and female terminator connectors. Each NEMA 2000 device connects to the backbone with a T connector. The system must be connected to power and terminators must be installed on both ends for the network to work properly.

Note that the Volvo engine uses a different network system to transfer their data. This system does connect to the Regal backbone to view data on the Garmin Glass Cockpit display.

The next page shows a typical backbone set-up for Garmin electronics on your vessel.

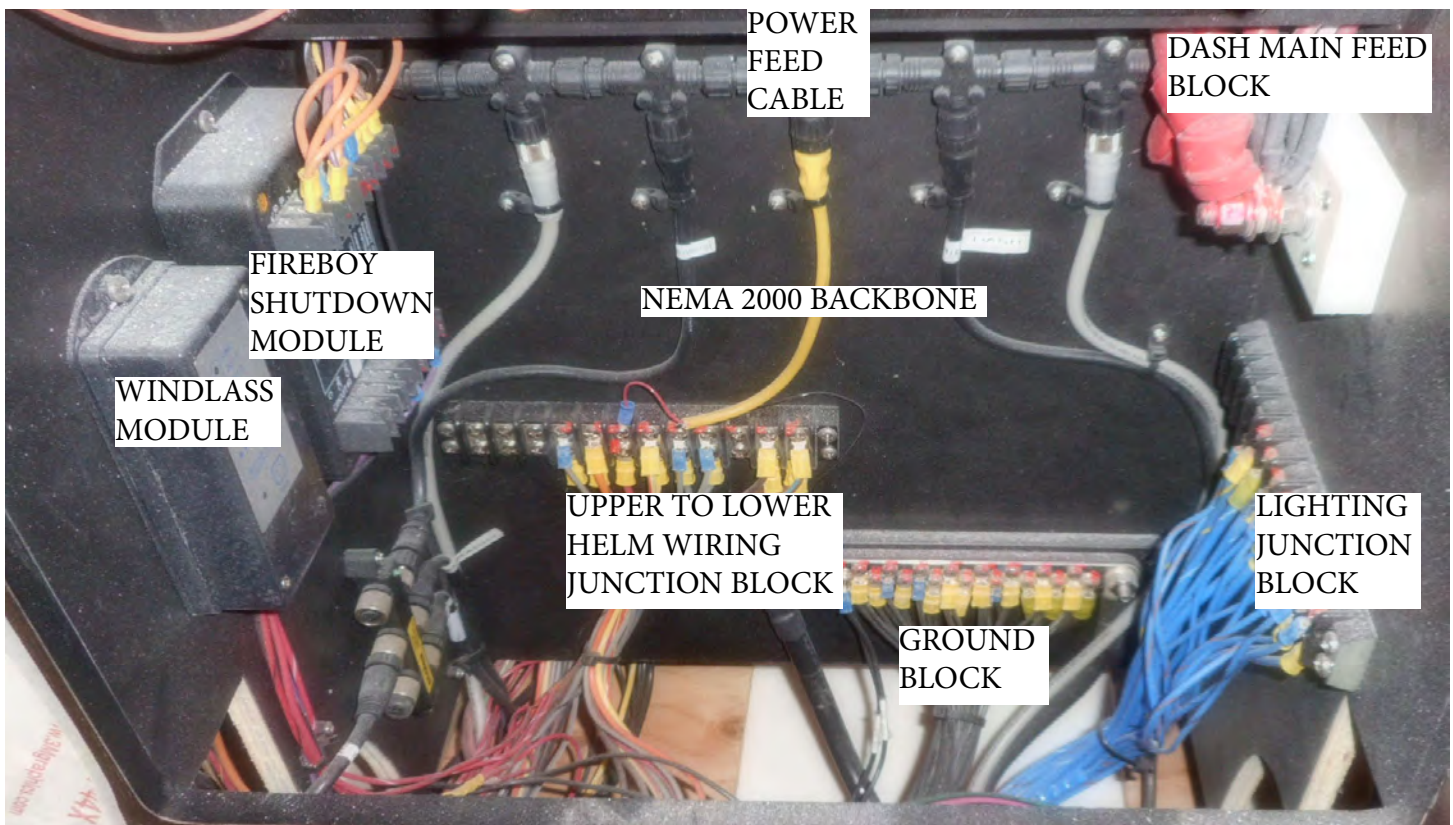

LOWER HELM LOCKER

The windlass module box triggers the windlass through the hand held dash remote control.

The Fireboy shutdown module is the backbone of the halon automatic fire extinguishing system on board your vessel. There is a Bosch relay installed in the locker that allows the shutdown system to operate properly.

Terminal strips are used for DC ground wires (black) and 12 volt current carrying wiring such as lighting. Other terminal strips act as junctions for upper and lower station DC component wiring ie., navigation lights.



TYPICAL NMEA 2000 NETWORK BACKBONE DESCRIPTION

Referring to the illustration regarding the lower helm locker below is some information on the NEMA 2000 system that may assist you understand what these cables are and where they go. Select ones will run to the bridge on the Fly model.

First of all, the NEMA 2000 backbone needs a power source for communication purposes which allows signals to be carried to the various electronic components. The yellow cable is the designated power cable and is powered when the helm electronics switch is activated. It is protected by a (positive red wire) fuse on a terminal strip and the negative portion of the circuit (black wire) runs to a ground terminal strip.

One of the gray cables normally runs to the lower helm area behind the Garmin to a multiport which connects to the plotter(s) and Volvo gateway. A multiport is normally a Molex brand with one incoming connection and 5 outgoing connections. See the illustration of the multiport on the next page. Note that the dust caps must remain on any unused multiport connections. The other gray cable goes to the main ship's panel terminal strip and terminates in the lower aft stateroom electronics locker.

A black cable (port side of backbone) runs to a helm mounted multiport and terminates at the bow and aft Fusion stereo remotes and the Fusion stereo.

The black cable (on the starboard side of the backbone) and is used for bridge models to a upper helm multiport and terminates at the plotter(s).

Your electronics package may include chartplotters, heavy duty closed-array radar, auto pilot, sonar with full-featured depth sounder functions, VHF radio with DSC capability and XM satellite weather radio.



TYPICAL LOWER STATEROOM COMPONENT LOCKER DESCRIPTION

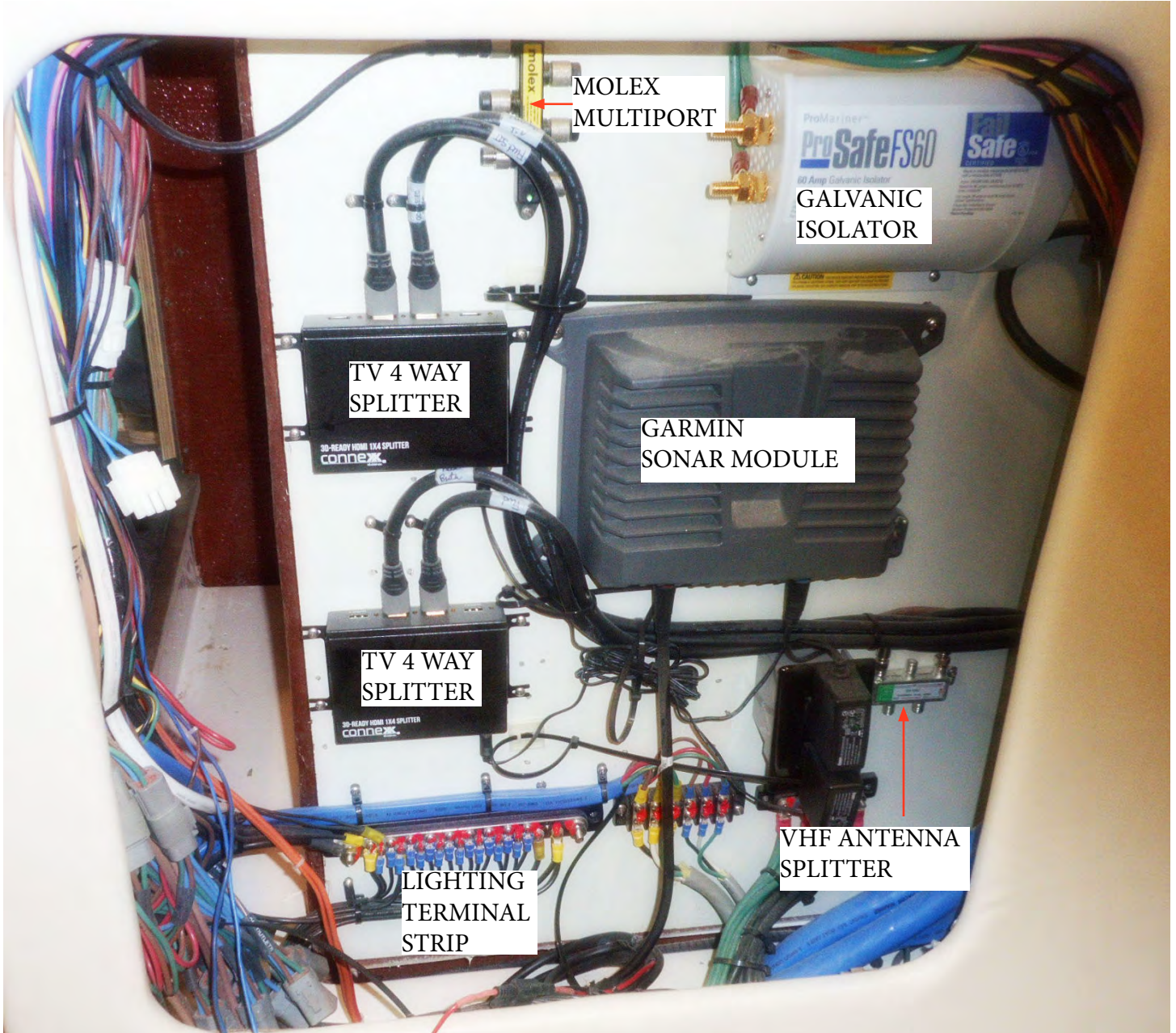

The television splitters permit you to play a DVD movie from the blue ray player and watch it on any of the tv's.

If installed, the Garmin sonar module sends and receives sonar signals such as bottom conditions, water depths and fishing information. This data is programmed into the Garmin plotter for viewing.

A VHF radio antenna splitter connects the cable from the unit to the masthead whip antenna.

The galvanic isolator is connected through the AC green earth ground wire system. Its purpose is to block low voltage DC current coming aboard your vessel with the shore power ground wire.



Typical Radar

Since the optional closed array radar unit is part of the vessel electronic marine network you will be able to use the chartplotter as your network screen and have the capability to overlay the radar image on the chartplotter map page. Components such as radar, GPS etc. are integrated on the electronics mast.



Radar Operation

Read the radar operator's manual for learning all the features of the radar component. It is a good idea to use the manual along side the chartplotter to master the basic radar operation.

At that point you can branch out with the manual on the secondary functions of the radar. Pay special attention to all safety and warning labels in the operator's manual.

 **WARNING**

RADAR PRODUCES ELECTROMAGNETIC ENERGY WHICH IS HARMFUL.
TURN THE RADAR OFF WHEN PERSONNEL ARE SERVICING THE UNIT OR EQUIPMENT CLOSE BY.

 **CAUTION**

AVOID POSSIBLE DAMAGE TO THE EYES DUE TO ELECTROMAGNETIC ENERGY.
WHEN RADAR IS TRANSMITTING DO NOT LOOK DIRECTLY AT THE ANTENNA WHEN AT CLOSE RANGE.



Typical Autopilot

The autopilot was developed specifically for the Volvo Inboard Performance System and Joystick which is the propulsion type used on your Regal yacht. If installed, the autopilot is part of the onboard marine network and therefore can be programmed to maintain a course through the chartplotter route. Easy-to-use setup provides carefree auto-guided navigation in open waters.

Autopilot Operation

The autopilot continuously adjusts the steering on your yacht to maintain a constant heading. The unit can be programmed for both automatic and manual steering functions and patterns.

Before using the auto pilot, be sure to read and understand the autopilot operation manual located in the owner's information packet.

WARNING

TO PREVENT POSSIBLE BODILY INJURY,
DEATH OR PROPERTY DAMAGE,
NEVER LEAVE THE HELM UNATTENDED.
BE PREPARED AT ANY TIME
TO PROMPTLY REGAIN MANUAL CONTROL
OF YOUR YACHT.

Follow these steps to start-up the autopilot;

1. Energize the “house” battery switch at the battery management system panel located at the cockpit stairway locker.
2. Turn on the helm electronic switch.
3. Press and hold the power button briefly to turn the autopilot on or off. If the power button is released quickly instead of briefly holding it the unit will seek the display adjustment screen verses the main screen.

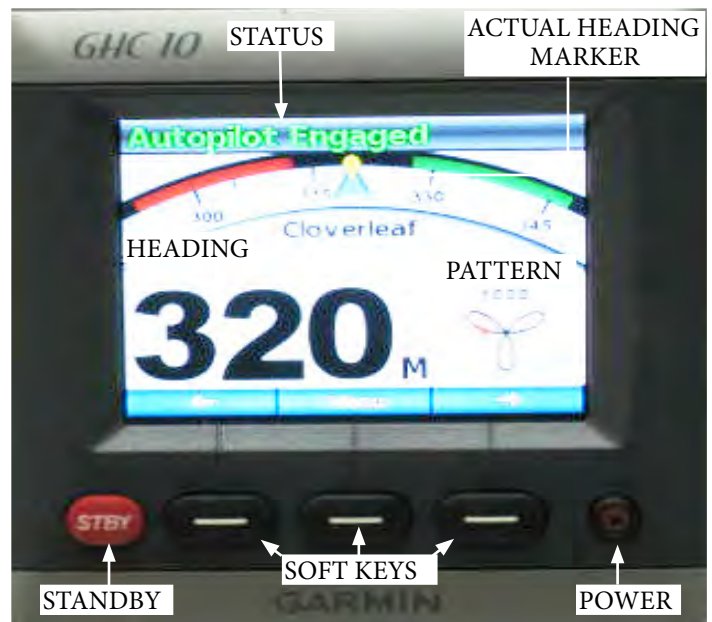

General Operation Keys & Descriptions

Power- Turns the autopilot on and off.

Soft Keys- These keys help to navigate the menus, select items, and change the autopilot steering bearing. The center soft key is used to select highlighted items and open a menu. The left soft key is used engage the unit or to move back one screen. The right soft key to navigate through the menu screens.

Note: Press a soft key to activate the action indicated directly above it.

STBY (Standby)- Press this button to start the standby function. Press STBY to stop the autopilot from any menu screen at any time. A time when you use STBY might be when you are beginning your route through a tight turning channel to a marina or to your favorite on the water restaurant.

Note 1: When you place the autopilot in standby mode be ready to regain manual control of the boat steering system.

Note 2- The heading sensor is a device that is integrated in the autopilot system that controls the direction inputs and outputs of the unit.



Status- If you press the STBY button on the heading screen “YOU HAVE THE HELM” appears in yellow cautionary lettering. At this point be prepared to manually take control of the helm steering.

Under normal conditions on the heading screen the status reads “AUTOPILOT ENGAGED” in green lettering.

Heading- When you engage the autopilot, it takes over the helm steering control and steers the boat to maintain your heading. This heading can be programmed through the autopilot which uses an on board flux-gate compass for bearings based on a magnetic north verses a true north heading. The autopilot heading can also be programmed through the chartplotter to follow a set of way points.

Actual Heading Marker- A yellow triangle (actual heading marker) is displayed and is normally the bearing you are heading.

Note: If the arrow keys are pressed to manually adjust the heading, the heading dial on the heading screen displays your actual heading while the autopilot steers the yacht to the intended heading.

Pattern- This screen icon shows various steering patterns for fishing and other speciality patterns such as zigzag, circles, U-Turn, and Man Overboard. Read and understand the autopilot owner’s manual description of these patterns and make sure the water is free of obstacles and you have an unlimited area to practice these steering patterns.



Typical Sonar

If installed, the sonar system used on your yacht provides full-featured depth sounder functions through the chartplotter. The sounder connects through the Garmin



Marine Network and shares various data with all connected chartplotters. It consists of a

sounder which connects to a transducer. The boat transducer

bounces signals from the sea bottom through the sounder and to the chart plotter for viewing. These

signals may include depths, water temperature and objects between the hull bottom and the sea bottom

such as fish. See the display which offers a sampling of possible sonar information available.

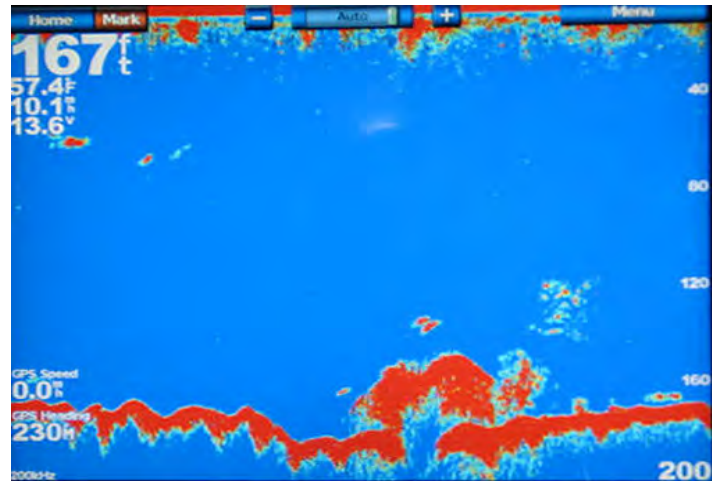

SONAR FULL SCREEN SAMPLING

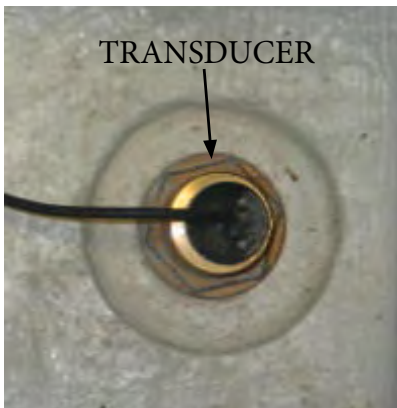

Read and understand the sonar owner's manual. It will aid in interpreting the various signals shown on the chart plotter display and show the versatility of the sonar component. See location information in the earlier electronics section of this chapter.



Typical Satellite Weather

If installed satellite weather may feature a weather receiver located in the forward deck rope locker area. It looks like a hockey puck. The receiver sends satellite weather information to the chartplotter for display. Along with the receiver an active subscription is required to receive satellite weather.

The weather information is received from reputable weather data centers such as the National Weather Service and the Hydrometeorological Prediction Center. Since weather information is broadcast at five second intervals the weather receiver must obtain new data before it can be shown. Therefore, there might be a delay before new weather data appears on the map.

Read and understand the XM weather information located in the chartplotter owner's manual before attempting to use the weather option.



Engines & Controls

OVERVIEW- FUNDAMENTALS



This chapter introduces the IPS propulsion system-both diesel engine and drive. This is not to be thought of as a complete workshop manual. This chapter will highlight a portion of the engine and IPS information. Read the Volvo operator's manual (IPS) carefully and understand the operation as well as the necessary maintenance requirements of the

engines and related IPS drive system components before operating the vessel. Contact your closest yacht dealer or Volvo repair facility for maintenance and/or parts needs. Always begin maneuvering in a controlled environment where you can practice shifting and docking operations at your own pace. Learn how the vessel's engines and propulsion systems behave at different speeds, in varied sea conditions, and under light and heavy loads. Always keep the safety of others in mind as you practice docking with the joystick control.

Learn to monitor the helm "glass cockpit" displays, electronic equipment, and warning systems as they are your on board friends. Read all safety labels and practices. Review with a crew member all the component operations in case the captain would become unable to carry out his duties as skipper.

Note: Your Regal yacht dealer has been factory trained on the various yacht systems. Consult your Regal yacht dealer for further information regarding technical support and parts.



WARNING

AVOID SERIOUS INJURY OR DEATH!
READ ALL MANUFACTURER'S ENGINE
AND PROPULSION MANUALS
BEFORE STARTING OR OPERATING
THE VESSEL.



CAUTION

NEVER RUN ENGINES WITHOUT WATER.
DAMAGE TO THE WATER PUMP, IMPELLER,
AND OTHER ENGINE PARTS
WILL OCCUR.



ENGINE BREAK-IN: ALL MODELS

Diesel propulsion systems require a pre-determined “break in” period. During this time the engine should not be run at a full load condition for extended periods. Various engine load and speed conditions assist the internal engine parts such as bearings, valves and piston rings to “seat” properly which will help ensure a longer engine life. See operator’s manual for further information.

During the “break in” period it is necessary to check the engine oil more frequently since it is normal that the engine will use more oil. If engine oil is required be sure to check the engine manual for proper grade and viscosity.

Check the maintenance schedule in your engine owner’s manual and contact your Regal yacht dealer to set up the first maintenance inspection. Normally the engine oil, filters, and drive oil inspections and maintenance are performed during this inspection along with other items. Never exceed a 12 month period between oil changes especially with diesel power since sulfur tends to enter the lubrication system through the fuel combustion process over a period of time.

OIL CHANGES (ENGINE & DRIVE)

Be sure to read the owner’s manual regarding engine oil change recommendations along with IPS stern drive oil. Be sure to follow the Volvo recommended oil type and viscosity. The engine oil change is an important factor in obtaining engine longevity since impurities enter the crankcase through the combustion process and build up in the engine oil.

Be sure to check the drive oil on a periodic basis and change it using the recommended type per the Volvo engine owner’s manual.



VENTILATION SYSTEM- DIESEL



With diesel engines large amounts of air are required to perform the combustion process. The higher the revolutions per minute of the

engine the more air is required to meet the demand. Since diesels compress the air at a much higher ratio than similar gasoline models that require a spark in the process the chance of explosion or fire is much lower with diesel power. Therefore, it is not necessary to force the exhaust from the sump with a powered ventilation system like the gas engine.

Diesel engines exhaust large amounts of incoming air by mixing it through the combustion process and forcing the air through the engine exhaust system into the water. The same deck cowlings are used to funnel incoming air for combustion. The remaining air exits through the cowlings into the atmosphere.

This “breathing cycle” occurs naturally within the diesel with more oxygen being required as the throttle speeds are increased.

As part of diesel maintenance, ensure the cowlings are free of debris including animal nests such as wasps and birds. Check and replace the diesel engine air filters as required. Note that the diesel air filter can not be cleaned so scrap it and replace according to maintenance schedules. See your nearest Regal yacht dealer for filter parts.

Also, it is recommended that after a cruise you let the engines and generator idle under a ‘no load’ condition for several minutes. Perform a visual check for exhaust and fluid leaks in the bilge. Since there is a light gelcoat color in the bilge bottom it will be easier to spot any fluid leaks.

Note: Never modify or obstruct any part of the natural or if installed power ventilation systems.



WARNING

BEFORE STARTING ENGINES
CHECK ENGINE COMPARTMENT
FOR FUEL LEAKS.



WARNING

TO PREVENT FIRE OR EXPLOSION
DO NOT STORE
FLAMMABLE LIQUIDS IN CONTAINERS
ANYWHERE ON THE VESSEL!



VOLVO IPS DIESEL E-KEY SYSTEM

Volvo IPS propulsion packages feature the advanced E-key technology. This system consists of two main components; the key panel and the key fob. The key panel used on Regal IPS yachts is engineered for both engines to be started independently after one swap of the key fob. The same key fob motion is used to stop the engines.

If a key gets lost you can easily remove that key from the approved key listing and approve another one as a replacement. If all keys get lost the VODIA tool must be used to add new keys to the system.

This system supplies a high level of theft protection.

Hold the key fob in front of the O symbol on the panel to unlock the EVC system. A sound confirms the system is unlocked. When the electrical system is locked a red light flashes under the symbol. The lamp goes out to indicate the system is unlocked.

NOTICE

WITH THE ELECTRIC BATTERY SWITCHES
IN THE "OFF" POSITION
THERE IS NO POWER TO THE DASH
KEY FOB SYSTEM.



E-KEY PANEL



KEY FOB

Refer to the Volvo IPS operator's manual for more information on the E-key system.



Engine & Controls

VOLVO AUX. STOP SWITCH



To stop the engine should the key fob system fail to shut down the engine there is an auxiliary stop switch located in the sump on the side of each engine. Depress the button until the engine completely stops. See the illustration.

BATTERY PARALLEL SYSTEM



E-KEY PANEL

BATTERY
PARALLEL
SWITCH

The battery parallel system permits an engine with a discharged or dead cranking battery to be started by the other engine cranking battery through the use of a crossover system including sensing relays located at the battery management panel.

To use the system just depress and hold the parallel switch for 10 to 15 seconds. This will cause the relay to shut and allow the discharged battery to receive a brief surge of energy from the charged battery.

At that point press the engine start switch of the engine with the discharged battery while holding the battery parallel switch down. The engine will crank and start.

Check your engine motoring panel to check battery voltage which should be between 12 and 15 volts. As the discharged battery becomes charged the voltage should show more toward the 12.5 volts. When the battery is fully charged the relay will open and will keep voltage intact.

Always find the reason for a discharged or dead engine cranking battery situation. Make sure you periodically check the entire battery system for proper acid levels if using wet cell technology. In addition, check all hardware for tightness, corrosion and wear (chafing).



TYPICAL 42 FLY/GRANDE COUPE HELM OVERVIEW



- Glass Cockpit Optional Plotter Units Shown
- Switch Panels
- VHF Radio
- Windlass Remote
- Trim Tab Controls
- E-Key Panel w/ Battery Parallel
- Acc. 12 Volt Plug
- EVC Remote Controls
- High Water Alarm
- Joy Stick
- Auto Fire Ext. Alarm

Note: Various components above are optional equipment. Location and components shown may change at any time.



DIGITAL INSTRUMENTATION

The Regal yacht helm station (dash) is equipped with a chartplotter system referred to as the “glass cockpit” which monitors the condition of the Volvo IPS propulsion components. It takes the place of the older analog gauges. Propulsion signals are read digitally and sent to the plotter for display and monitoring through a system called NMEA 2000. Close observation of the plotter system is the responsibility of the captain while cruising. Periodically scan the screen for all the key propulsion readings. The plotter system also provide GPS and navigational information for components such as radar (if installed) and monitors the Fusion® entertainment system.

Other dash instruments called displays present digital information on various systems. Become familiar with all the gauge functions and their normal operating specifications as outlined in this manual and the Volvo engine operation manual.

After educating yourself in the functionality of the “glass cockpit” be sure to train another person as the skipper’s backup. This person should know how to read the screen and how to respond to system “fault” codes should they occur.



Oil Pressure Readout-Plotter

The oil pressure display indicates the pressure of the oil inside the engine lubrication system. A drop in oil pressure may be an indication of a low oil situation or a leak. Operation of the engines with low oil pressure could lead to engine damage. Should a low oil pressure situation develop shut down the engine immediately and investigate the problem. Refer to the Volvo engine operation manual for more information or contact your closest Regal yacht dealer.

Temperature Readout-Plotter

The temperature display monitors the cooling system of the engine. A sudden increase in the temperature could be a sign that the engine cooling system is malfunctioning. Shut down the engine immediately and investigate the problem. Consult your engine manual for allowable limits.

Speed Readout-Plotter

The speed display indicates kilometers per hour. There may be a slight amount of error in speed readings.

Voltage Readout-Plotter

The voltage display indicates the battery condition as well as the alternator performance. Normal voltage is between 12.0 and 15.0 volts. Readings outside of this range may indicate a charging system or battery problem.

NOTICE

BECOME FAMILIAR WITH THE ENGINE FAULT CODE SYSTEM. SHOULD A ENGINE MALFUNCTION DEVELOP THE OPERATOR WILL BE ABLE TO REACT FASTER TO THE SITUATION.



Engine & Controls

Automatic Fire Extinguisher System



Utilizes an instrument display unit (gauge) that provides the operator with a system status of a charged or uncharged condition by an audible alarm. With the ignition switch on and no light indicates that the system

has been discharged.

If the system should discharge the ignition system will be instantaneously interrupted. Should this occur shut down the engine and any electrical system components along with closing any open hatches.

High Water Alarm



Using a bilge float sensor this component determines a high water bilge situation and sends a signal to the dash alarm. This may indicate that a large amount of water has entered the hull or there is a leak in the engine water circulation system

and the bilge pump cannot evacuate water overboard fast enough or has failed to operate. Periodically, activate the bilge pump manually to check operation.

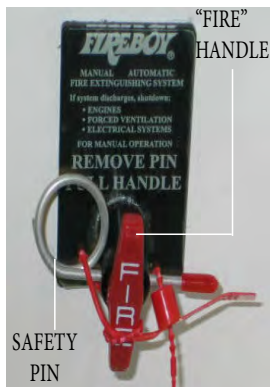

If a fire has started in the engine compartment find the system manual cable assembly located in the cockpit. Remove the safety pin from the "Fire T Handle" and pull firmly on the "Fire" handle which will activate the fire extinguisher unit in the engine compartment. A loud "rushing air" sound may be heard. Complete discharge will take several seconds. Keep the compartment closed for a

period of time sufficient to permit the agent to soak all areas of the protected space. This allows hot metals and fuel time to cool. Refer to the manufacturer's owner's manual for additional information.



IPS ENGINES

It is important that you read the Volvo operator's manual (IPS) carefully and become completely familiar with the operation as well as required maintenance procedures on the engines and related IPS propulsion systems.

BEFORE STARTING ENGINES

Before starting the engines check the guidelines below:

1. Open the engine hatch and sniff for fuel smells and visually check for fuel leaks. If diesel fuel is sensed or leaks seen be sure to determine the cause and repair the source before starting the engines. If you can not locate a diesel fuel leak contact a marine professional immediately or your closest Regal yacht dealer.
2. Remove any loose canvas and store in a dry location.
3. Shut and secure all hatches and doors.
4. Remove any debris from the engine water strainers before turning on the seacock handle.
5. Ensure both engine seacocks are in the "open" position. In the open position the handle is in line with the incoming hose not perpendicular to it. In addition, open the IPS stern drive sea cocks.
6. Make sure the swim ladder is secured in its folded position and that the cover is in place.
7. Check fuel supply levels. Use the fuel "1/3" rule.
8. Turn all battery switches to the "on" position at the battery management panel.
9. Activate the VHF and listen for the latest weather conditions.
10. Activate the plotter and radar checking their functions.

11. Make sure all passengers are accounted for, seated and their life jackets are properly fitted.
12. Check for a balanced load.
13. Before disembarking make sure a person is aboard who knows how to operate the vessel and is trained in emergency procedures in case the captain would not be able to carry out his duties.
14. Inspect the engine and drive oil levels. Add specified oil as required.
15. Check engine coolant levels. Add specified coolant as required.

AFTER STARTING ENGINES

1. Allow the engines to idle for a short period as they warm up. Never race a cold engine!
2. Check gauges for proper operation. Pay particular attention to volts, oil pressure and temperature display panel functions as they are key indicators of a proper performing engine. Also, check that no alarms are displayed and no warning lights are flashing.
3. Open the engine compartment and listen to each engine for unusual sounds.
4. Inspect the fuel, exhaust, and engine circulation system for leaks.
5. Visually check the entire sump (bilge) for any unusual conditions.
6. Visually check the through hull fittings for the proper water output from components such the air conditioner pumps and generator.



TYPICAL VOLVO IPS DIESEL SUMP (BILGE) OVERVIEW

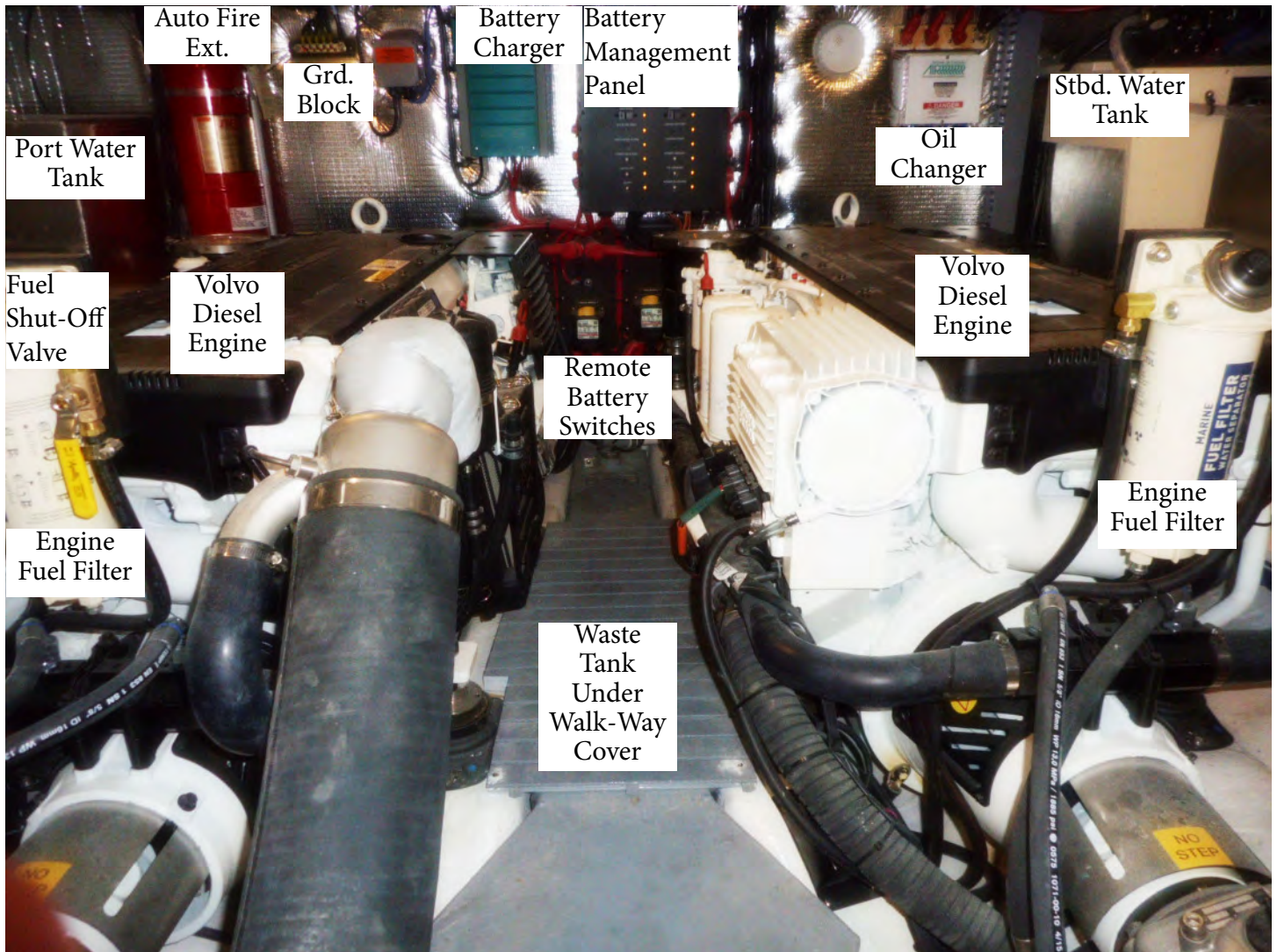

Note: Equipment shown may be optional. Components, systems and locations are subject to change at any time.



TYPICAL VOLVO EVC REMOTE CONTROL



Station button- featured for multi-station boats. Since Regal yachts feature one helm the station button lights up “green” when the control is activated but this function can’t be configured.

Throttle Only button- when pressed it disconnects the shift function. At this point the control lever only effects the engine speed.

Low Speed- This function reduces the low speed engine capability. Refer to the IPS operator’s manual.

Cruise Control button- when pressed it permits the operator to fine tune by increasing or decreasing engine rpm with the button on the forward side of the control. Use the arrows on the button to increase or decrease engine rpm.

Other indicators- On the port and starboard sides of the control various icons are displayed including the following:

Neutral position- This symbol shows that the engine and drive are disengaged.

Warning triangle- This symbol lights up when a system fault is recognized. It will project on the side where the driveline with the problem exists.

The Volvo control offers several button options which can be added through the retail dealer who orders the needed software from Volvo.

For more detailed information refer to the Volvo IPS operator’s manual or contact your closest Regal yacht dealer.

NOTICE

PRACTICE YOUR REMOTE CONTROL
SHIFTING IN A WATER
ENVIRONMENT WITHOUT HEAVY
BOAT TRAFFIC.

 **WARNING**

TO PREVENT POSSIBLE BODILY INJURY
AND PROPERTY DAMAGE
DO NOT ATTEMPT TO ADJUST SHIFT
OR THROTTLE CONTROLS!
CONSULT A MARINE PROFESSIONAL.



TYPICAL JOYSTICK CONTROL

Using Joystick Control Docking Mode Function

When using the joystick for docking the engine rpm scale is limited and the boat can only be steered with the joystick.

For the docking mode to be activated the engines must be running, the remote control levers must be in the neutral position, with an active helm station, and the joystick handle must be centered.

First, activate the docking mode on the joystick by depressing the “docking” button (A). You will hear an audible signal confirming the docking function is activated along with a button lamp being energized. The joystick is now the control for docking and low speed maneuvering.

Next, to deactivate the docking mode depress the docking button on the joystick. Again, an audible signal will sound twice to confirm that the joystick docking mode is now deactivated and the docking button light will go out.

Note: If the remote controls are moved from the neutral position the docking function will deactivate.

Using Joystick Control High Mode Function

Sometimes a strong wind or current will need to be offset by engaging the high mode function at the joystick control. Once activated the engine idle will increase. This feature can be especially useful when trying to dock or maneuver in tight areas.

To use the High Mode Function;

1. Activate the high mode by pressing button (B) on the joystick (see the illustration).
2. You will hear an audible signal indicating the docking mode is activated and the docking lamp above the high mode button will light (see illustration).
3. At this point the vessel can be maneuvered by moving the joystick fore and aft, sideways, or rotating the vessel by twisting the joystick top. See the illustration on the following page.
4. Leave the high mode function by pressing button (B). An audible signal will sound twice to confirm that the high mode function is deactivated and the light will go out.
5. The system is now in normal docking mode not connected to the joystick control.



NOTICE

USE THE JOYSTICK ONLY IN DOCKING SITUATIONS. USE THE STEERING WHEEL AND REMOTE CONTROLS IN ALL OTHER APPLICATIONS.

The joystick features a DPS (dynamic positioning system) button option which can be activated through the retail dealer who can order the needed software from Volvo.

The DPS feature assists in retaining a selected position and compass heading from the vessel's GPS signal. This can be beneficial while waiting for a dock or a bridge to open or to remain over a favorite fishing or diving location.

When employing this feature the operator must maintain helm control since legally the vessel is considered to be under way. Also, keep several boat lengths away from swimmers, other vessels and objects.

Read the helpful hints while docking using the joystick in chapter 6.



Engine & Controls

JOYSTICK FUNCTIONS

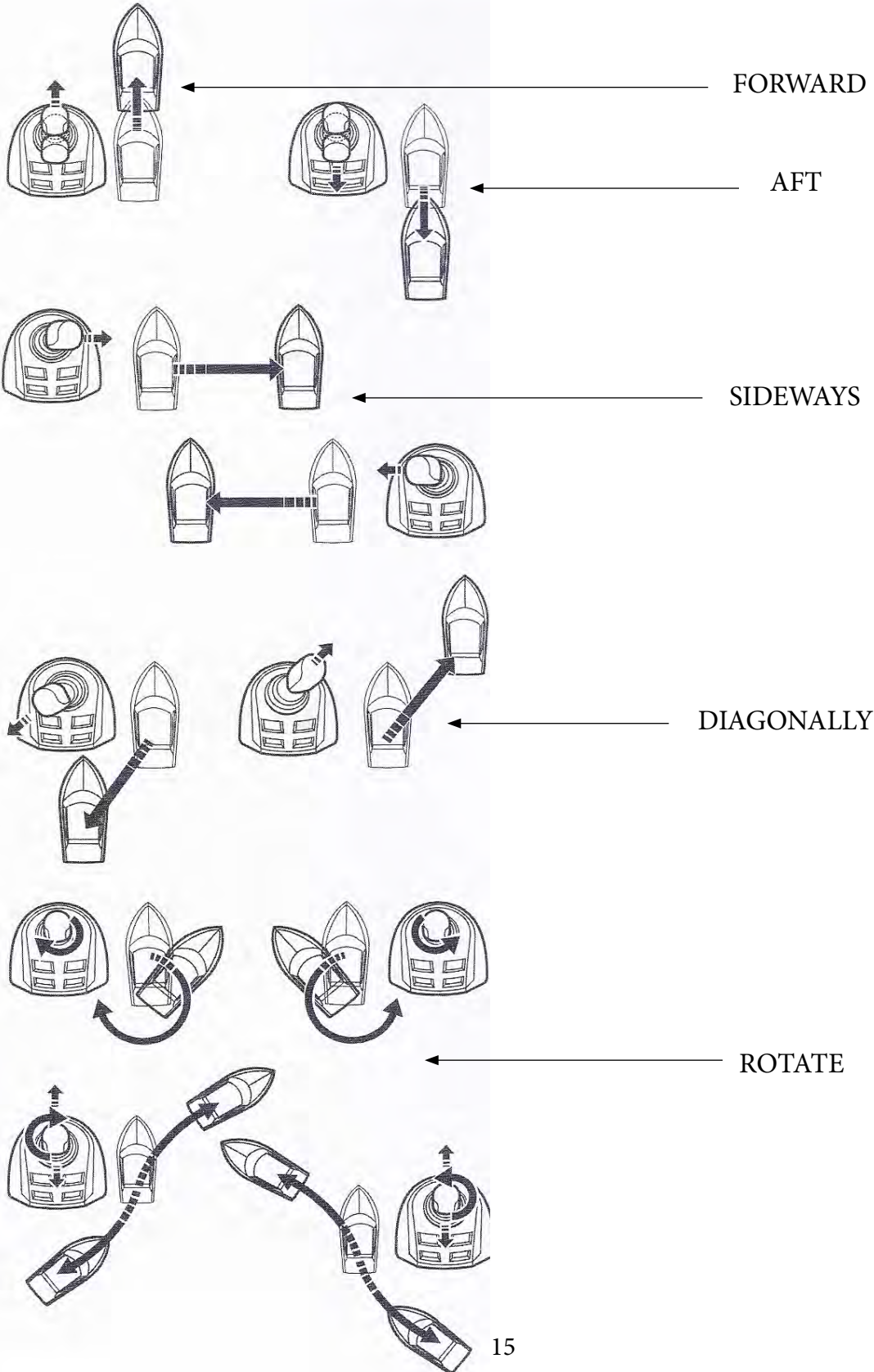



VOLVO IPS PROPULSION SYSTEM

IPS TYPICAL DRIVE OVERCURRENT BKR.

INTRODUCTION

The Volvo IPS stands for inboard performance system. It offers some of the following benefits over other propulsion systems.

IPS propulsion features high efficiency and top speeds. Low-speed maneuvering is much easier due to the dual counter-rotating propellers driving thrust in the direction needed for close-up docking operations.

The engine and drive units are quiet due to unique rubber suspension. Propellers are efficient due to their forward facing position working in undisturbed water with no cavitation.

The engine features common rail injection, 4 valves per cylinder, double overhead camshafts, and turbocharger for maximum fuel compression, along with a compressor and aftercooler.



The IPS drive unit 50 amp breaker is mounted near the top of the engine close to the dual oil filters. It protects the drive unit from being overloaded. If a breaker “pops” always figure out the reason why before resetting or replacing it. Also, there is a 20 amp

accessory breaker mounted on the engine. Refer to the Volvo operation manual for further information.



Emergency Steering

There is a procedure to align a propulsion unit in a straight forward operation should a fault develop that does not permit the unit to be steered from the helm.

The captain determines if the alignment procedure is needed as a measure to maneuver the vessel to a safe harbor.

If both units can not be steered from the helm than both propulsion units must be aligned and the control levers are used to steer the vessel.

Use care when working in the sump. The alignment procedure can be carried out without the engine running which is much safer.

There is a switch tool which is part of a tool kit. The switch is depressed while the crank is turned until it reaches an end position which feels like a compression spring being wound up.

Read and understand the Volvo Penta IPS Operator's manual which includes drawings and step by step procedure to align the unit(s) straight.



WARNING

Bottom Solenoid For

PREVENT BODILY INJURY!
IN THE EMERGENCY SHIFT MODE THE UNIT
IS LOCKED IN FORWARD GEAR
AND CANNOT BE DISENGAGED
WITH THE CONTROL LEVEL.
THE VESSEL CAN ONLY BE
STOPPED WITH THE KEY FOB
OR AUX. STOP CONTROL BUTTON.



VOLVO IPS PROPELLERS

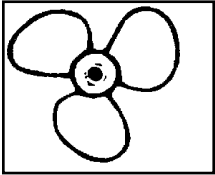

We have carefully tested and chosen the propellers to give your boat the best possible performance and have allowed for the additional weight in equipment that might be added to the boat.

Carry the necessary tools in order to handle an emergency propeller change including a set of extra propellers and hardware. Always use genuine Volvo replacement parts which can be ordered from your Regal yacht dealer.

Many times a boater is cruising far from his mooring when he needs emergency repairs. A facility may be able to sling your vessel for propeller changing but may not have the special hardware or correctly sized propellers for your vessel. Be prepared!

Twin IPS drive vessel propellers are balanced to achieve the highest performance standards along with running a straight course with no power steering torque.

The IPS system features series a Nybral series propeller system. As the name designates, the propellers are made of nickel, bronze and aluminum. Identify the exact type of Nybral propeller installed on your vessel so you can carry an extra set for emergencies. Use the chapter 8 chart as a guide but check the propellers themselves for exact stamped type.

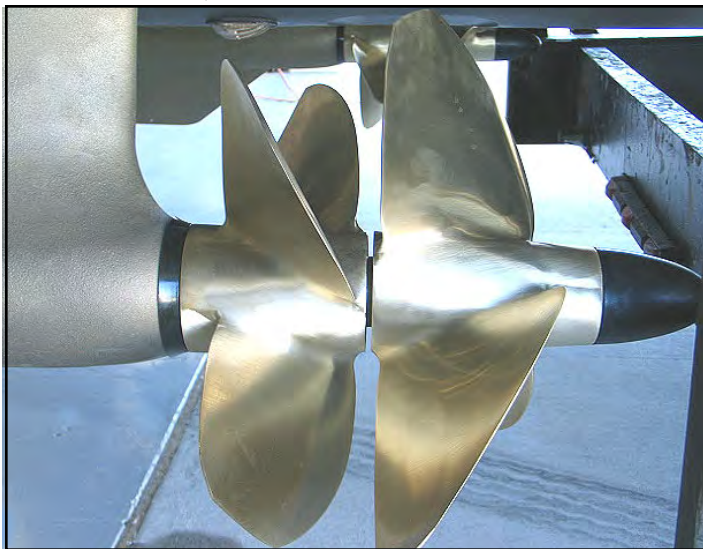

IPS FORWARD FACING NYBRAL PROPELLERS

NOTICE

NEVER CONTINUOUSLY RUN WITH A DAMAGED PROPELLER SINCE TRANSMISSION AND/OR ENGINE DAMAGE COULD RESULT.



DANGER

PREVENT SEVERE INJURY OR DEATH!
SHUT DOWN KEY FOB PANEL &
STORE KEY FOBs NEAR SWIMMERS
TO AVOID ROTATING PROPELLER BLADES.

To check the propellers the vessel must be lifted using a hoist with proper type slings that are specified for larger vessels.

Make sure you read and understand the proper procedures for slinging the vessel before attempting to hoist your yacht. There are 2 sets of "sling" identification deck markers. The markers provide a safe lifting location for sling straps. Make sure the slings used are wide enough to support the boat weight.

After the propellers are removed they can be sent to a propeller repair facility to check balance and recondition the blades.

Also, the drive anodes can be checked/changed when the yacht is out of the water. One anode is located on the drive and the other anode is located on the transom. Use emery paper to clean oxidized anodes not a wire brush. A spare set of propellers can be installed while the original set is being repaired. Refer to the Volvo IPS operation manual for further detailed information regarding the changing of propellers.



<u>NYBRAL PROPELLER USAGE CHART</u>
<u>VOLVO 500 DIESEL</u>
<u>GRANDE COUPE= T 3</u>
<u>FLY=T 3</u>
<u>VOLVO 600 DIESEL</u>
<u>GRANDE COUPE= T-4</u>
<u>FLY= T-4</u>





Vessel Operation



This chapter explores select parts of running your vessel from casting off to docking and handling emergencies.

We recommend further reading to

enhance your information on the chapter topics. Also, become familiar with your engine owner's manual since many of the items noted here are found there in further detail.

GETTING UNDERWAY

Pre-Departure Questionnaire

- Have all fluid levels been topped off?
- Is the fuel tank full?
- Are the propellers in good condition?
- Is the drain plug in place (dry stored vessels)?
- Have all passengers been briefed on all emergency procedures and seated for departure? Is the boat load balanced?
- Is all safety equipment accounted for and easily accessible?
- Are navigation lights and sound signals in good working condition?
- Is the bilge free of water and do the bilge pumps operate?
- Is the operator sober, alert and ready to skipper the vessel?
- Have all passengers been fitted for the proper size life jackets?
- Has a float plan been filed and left with a competent person?
- Has the bilge been sniffed and the fuel system leak checked?
- Are the appropriate sea cocks open?
- Is all communication equipment in good operating condition?
- Has a second person been briefed on operational, emergency, and VHF procedures should the skipper become disabled?



- Are all gauges and electrical switches functioning properly?
- Has weather information been gathered and analyzed?

UNDERWAY QUESTIONNAIRE

- After casting off have all dock lines and fenders been stowed?
- Are all passengers seated?
- As skipper are you monitoring the dash gauges and chart plotter for changes?
- As skipper are you on the lookout for changing weather?
- As skipper are you checking for abnormal vibration or steering?

DISSEMBARKING QUESTIONNAIRE

- Have you removed the keys from the ignition and secured them?
- Have all systems been checked for leaks?
- Have the battery switches been turned to the "off" position?
- Are all storage compartments and seacocks closed?
- Has the fuel tank been filled enough to assist in preventing condensation?
- Is the vessel properly tied and covered with equipment stored?



WARNING

PRACTICE "NO SMOKING" AND EXTINGUISH ALL FLAMMABLE MATERIALS WITHIN 75 FEET OF ANY FUEL DOCK.



WARNING

PREVENT INJURY OR DEATH FROM FIRE CAUSED BY LEAKING DIESEL FUEL. INSPECT ENTIRE FUEL SYSTEM AT LEAST ONCE A YEAR.



WARNING

TO PREVENT INJURY OR DEATH USE ONLY GENUINE MARINE ENGINE/DRIVE REPLACEMENT PARTS

NOTICE

SINCE DIESEL IS AVAILABLE IN VARIOUS SEASONAL BLENDS, REFER TO THE ENGINE MANUFACTURER'S OPERATION MANUAL FOR ACCEPTABLE TYPES.



BEFORE FUELING

Note: To be extra safe the skipper should follow the procedures below for fueling diesel that are normally defined for petrol. Gasoline exhibits much greater flammable/explosive characteristics but diesel can ignite and burn under the right conditions.

- Make sure a working fire extinguisher is at close hand.
- Stop engines while fueling.
- Disembark all passengers and crew not needed for fueling.
- Fuel if possible during the daylight hours.
- Check to ensure nobody is smoking in the boat or near the fueling dock.
- Close all enclosures to keep vapors from blowing aboard and settling in the bilge.
- Tie up your boat securely at the fuel dock.
- Identify the fuel fill.
- Visually inspect all fuel system components before each filling.

DURING FUELING

- Keep the fuel nozzle in contact with the fuel fill to guard against static sparks. The fuel fill pipe is grounded through the fuel system wiring to protect against static electricity.
- Avoid overfilling the fuel tank. Leave room for expansion.
- Avoid spilling any fuel. Clean up any fuel accidentally spilled with a clean rag and dispose of it on shore.

AFTER FUELING

- Close all fuel fill openings tightly.
- Open all hatches.
- Sniff in the lower bilge and engine compartment for diesel fumes. If fumes are detected find the cause of the diesel odor until the odor is gone. Look for any traces of fuel droplets or spillage.
Do not start the engines, smoke or run any electrical components until the fumes can no longer be detected.



STARTING & STOPPING

The following general information covers starting and stopping your engines. Read and understand all previous information on remote controls, fueling and operational procedures. Pay particular attention to all labels. Refer to the engine operation manual for in-depth propulsion system information.

Review all pre-departure information. Before starting your engines make sure all canvas is removed and stored. Start engines only in a well ventilated location to avoid diesel exhaust buildup. Make sure all battery switches are activated. Close and lock the center windshield section.

STARTING GUIDELINES

Position the remote control handles in the neutral position. Keep passengers seated and away from controls. If the engine does not start, refrain from cranking the engine over 10-12 seconds. Allow the starter and battery a chance to recover. Advance the remote control in the neutral throttle position only as recommended in the engine manual. Do not race the remote control in the neutral position.

A key fob system is used to start the engines. The system uses two main parts; the key panel and the key fob. Two key fobs come with dual engine installation along with a 2.5" key panel. The key panel uses lighted icons to show active ignition and start/stop positions. Theft protection is vastly improved with the E-key system.

If the starter stays engaged for more than 30 seconds the circuit is automatically cut to protect the starter from overheating. If this happens, let the starter cool for several minutes before attempting to restart the engine.

Note: With all the above systems, refer to the Volvo operator's manual for further information.

 **WARNING**

AVOID PERSONAL INJURY OR DEATH!
WHEN ENGINE IS RUNNING
TRANSOM DOOR MUST
BE CLOSED AND LOCKED.
SWIM PLATFORM
AND LADDER MUST NOT BE IN USE.

 **WARNING**

AVOID SERIOUS INJURY OR DEATH!
THE OPERATOR OF THE CRAFT
MUST HAVE COMPLETE CONTROL
OF THE HELM STEERING STATION
WHILE THE VESSEL IS MOVING.
NEVER LEAVE THE HELM
STEERING STATION UNATTENDED
WHILE THE VESSEL IS MOVING.



SHIFTING GUIDELINES

Before shifting into reverse or forward make sure the coast is clear. When shifting to either gear from neutral make sure the throttle is in the idle position. Do not pause but engage the shifter quickly into the desired gear. Allow your vessel to lose all headway before shifting into reverse or forward gear. Practice shifting! You will become more familiar with the procedure and self-confidence will build especially in tight docking situations. Most importantly, stay alert!

When maneuvering into a tight slip or pier be sure to use the IPS joystick “docking” button. If the current or wind is strong use the joystick “high” button which will supply increased idling speeds.

STOPPING GUIDELINES

Before stopping the engines make sure they are in neutral and at idle speed. After an outing let the engines cool down by idling for a few minutes before turning the ignition off. Glance at the gauges one last time to monitor their readings. Never turn the engine off while in forward or reverse gear or back up in excessive speeds since water could enter the engine through the exhaust system and cause extensive damage. Above all, use common sense.

CAUTION

AVOID ENGINE DAMAGE!

CHECK THE OIL GAUGE IMMEDIATELY
AFTER STARTING ENGINE.

IF LOW OR NO READING
SHUT DOWN ENGINE IMMEDIATELY
AND INVESTIGATE THE PROBLEM.

CAUTION

TO PREVENT INJURY DUE TO FALLING
DO NOT OCCUPY SUNPADS WHILE
VESSEL IS MOVING!

FENDERS

FENDER USAGE



Fenders are normally made of a rubberized plastic and are usually filled with air. Most have a fitting like a

basketball so they can be inflated or deflated. Fenders are available in a wide range of sizes and shapes to fit both small and large vessels. Fenders are normally designated in inches. They are used for protection between piers, docks, sea walls and the vessel. They protect the topsides of the boat from rubbing against rough objects. Most fenders have attachment eyes which allow a line to be inserted vertically or horizontally. This will permit the fender to be tied off to fit individual dock and tidal situations. Be sure the fender is correct for the vessel size. The standard fenders specified for your Regal yacht are 10” in diameter and 26” long. It is a good idea to carry extra fenders but half a dozen is normally an acceptable number. Remember to store fenders on board so they can be easily accessed. The forward stairway locker stores 2 fenders. Sometimes people call fenders “bumpers” but this is not correct nautical terminology.

FENDER TYPES



Additional yacht fenders can be ordered through your Regal yacht dealer. Explain how you moor and use your vessel so your dealer can recommend the best fender type for you. We suggest the type with a fill plug so you can inflate them with a hand pump like the ones used for bicycles or a 12 volt compressor (plugged into the 12 volt vessel accessory plug).



DOCK LINE BASICS

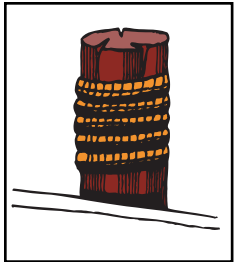

Most skippers use dock line terminology fairly loose but there is more to the basics than just bow or stern lines. There are several lines that can be secured to the bow and stern and depending on their direction and use, can be called other names. Remember that “forward” and “aft” refer to the direction that a spring line runs from the vessel, and not where it is secured on board.

BOW AND STERN LINES

There is only one true bow line. It is secured to the forward cleat and run forward along the dock to prevent the vessel from moving to the stern. The stern line leads from a rear cleat to a piling or cleat on the dock astern of the vessel. This line keeps the boat from moving ahead. For small vessels these are the only lines needed for normal wind and current conditions. If located in a tidal environment, keep slack in the lines.

BREAST LINES

These lines are attached to the bow and stern that lead to nearly right angles from the center of the vessel to the dock. They help keep larger vessels from moving away from the dock, or are pulled in to help people board the vessel. Bigger vessels may use bow or quarter breast lines.

SPRING LINES

Most boats use two spring lines although it is possible to have four. They are called the after bow spring and forward quarter spring.

Bow springs are secured at the vessel’s bow area. Forward spring lines lead forward from the boat to the dock and control movement stern ward. After springs stem aft from the vessel, and stop movement ahead. Spring lines are used to prevent movement in a berth, ahead or astern. They are really useful in controlling the effects of a real active tidal surge. Spring lines are useful where fenders need to be kept in place against piles.

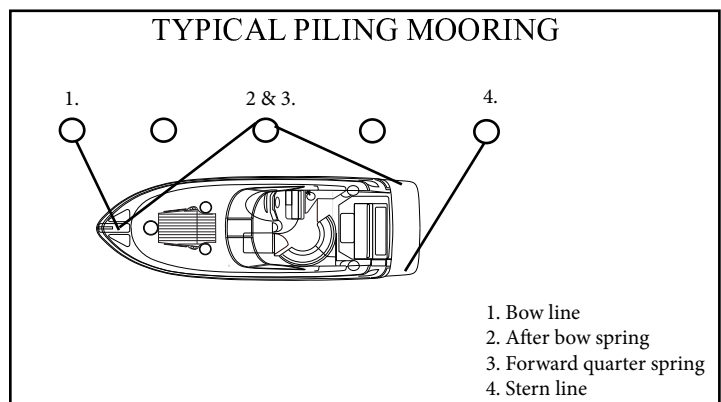
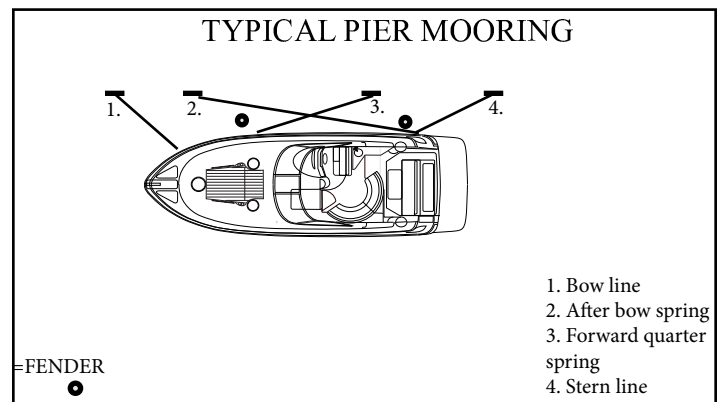

BOAT MOORING

Most boats can be secured to a dock using four lines. The after bow spring is crossed with the forward quarter spring and secured to individual dock cleats or pilings. This ensures longer springs and can be snugged up tighter for more efficient tidal control. Remember, if you only have one piling available, position the vessel so this point is opposite amidships. Run both spring lines to it. These lines will be shorter but still useful.



The bow and stern lines should be relatively at a 45 degree angle with the dock. The stern line can be attached to the near-shore quarter cleat, but will work more efficiently to the offshore quarter cleat. The longer line will allow the boat flow with the tide with less time checking the vessel.

DOCK LINE SIZING

Most dock lines today are made of nylon, either of twisted rope or braided core and cover. The most often used material is nylon because of its stretching abilities absorbing shock loads. It is chafe resistant for extended life and is easier on bare hands.

The line's size varies with the vessel. Normally, a vessel in the 50' range will use 5/8" diameter nylon lines.

Dock lines need to have the strength to hold the vessel and have enough density to resist chafing. They shouldn't be too heavy that they lose their shock-absorbing capabilities. Use the right size line for the vessel since a line too large for the boat will pull hard against the vessel since it won't be forced to stretch. If the line is too small for the vessel, there is no margin for wear and chafe when under strain.

SECURING LINES

When mooring your boat, make sure the dock lines are secured at both ends. Depending on your situation you may need to loop the eye splice of the dock line around a piling. Sometimes the mooring line will lead down sharply from the piling to the deck cleat. Loop the eye splice around the piling twice to keep it from being pulled up off the pile. Pull the line through the looped eye if the mooring line is too small to go around the piling twice or too small to fit over once.

If you must drop a line over a piling that already holds another boat's line, run the eye of the line up through the first eye from below, then loop it over the pile. This will allow either line to be removed without disturbing the other. If another line is dropped over yours, simply reverse the process.

Secure a little slack in the other dock line, then slip your eye up through its loop and over the top of the pile. Your line can be dropped through the other eye.

Note: Never use the swim platform cleats for permanent mooring cleats.

DISEMBARKING-LEAVING THE DOCK

When debarking from a dock, it is easier to release the line from a cleat or piling, from on board the boat, as soon as you leave the dock. Loop a long line around the cleat or pier and leading both ends on board you can release the line easily. Slip one end around the cleat or pile, the pull it back on board. Release the line without the eye splice, so it will run freely from around the pile without hanging up on the splice.



KNOTS

Knots are useful in docking, towing and other emergency situations. Learning to tie knots requires practice. As they say “ Practice makes perfect”. Some of the knots used in boating are the square, bowline, anchor bend, clove hitch, figure eight and half hitch. There are several periodicals available that explain various knots and how to tie them effectively. An experienced skipper will know the basic nautical knots and will use them when on the water. Take the time to know the basic knots.

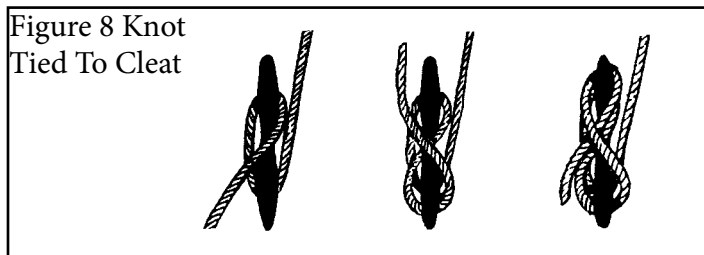

A useful knot to learn for general docking is the figure eight with one end reversed. By turning the free end of the line back under, the knot can be released without disturbing the boat. After some practice one person can secure a vessel easily to a dock or pier in a variety of weather conditions. This knot normally is used to tie the bow and stern. Then the vessel can further be fastened by tying the spring lines in the figure eight knot. Wrap it around the cleat 2 or 3 times.

DOCKING-GENERAL

As a general note docking and slow speed maneuvering can be one of those operations many skippers dread. The IPS joysick with a little practice makes you look like a pro while docking your vessel in wind, current, and tight mooring situations.

Read your engine manual to become familiar with the joystick and remote control components. It is a good idea to practice your beginning docking techniques in an open area. Remember practice makes perfect!

Helpful hints using the joystick;

1. For better control hold the joystick knob lightly almost like you would a delicate object. Push the joystick to the port or starboard, forward or aft and the rig instantaneously follows the fine finger movements on the joystick knob. Twist the knob and the boat spins on its own axis.
2. There are 2 buttons on the joystick. Use the gentler left one for most docking (Max. RPM's 1200). The right boost button is most useful in high wind/current situations (Max. RPM's 2000). This mode shows a marked increase in joysitick power.
3. Remember that both engines need to be in neutral before activating the joystick buttons or it will not work.
- 4.To disengage the joystick press the left joystick button again or engage one of the engine controls into gear.
- 5.The joystick brain responds to the turns not the position of the wheel. So whatever position you have the wheel facing when you disengage the stern drive joystick that is your new straight ahead position. Most seasoned skippers would position the wheel straight before disengaging the system.
6. You do not have to worry about disengaging the joystick and shifting the control into the drive mode at too high an rpm as the EVC system prevents any shifting above 750 rpm's.



ANCHORING

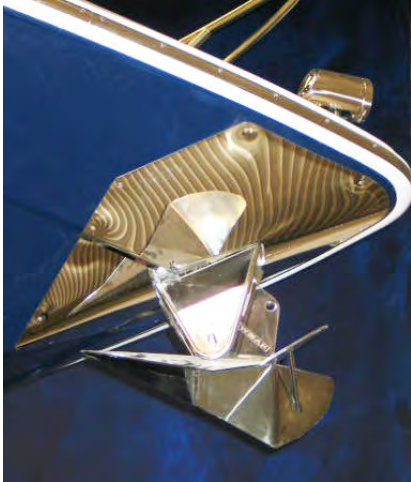

Your Regal yacht features a stainless steel plow type anchor. The anchor will set quickly in a variety of bottoms because of its unique shank profile and ballasted tip. It is a high holding type anchor made from high grade manganese steel and stainless steel

for maximum tensile strength. The anchor weight is 55 pound or (25) kg. Anchoring is easier with another person on board. First be certain that the line for the anchor is properly attached, to avoid losing the anchor and anchor line overboard.

For more efficiency, a 25' length of galvanized chain has been added to the rode length. The chain will stand up to the abrasion of sand, rock, or mud on the bottom much better than a nylon line. Being galvanized the chain will resist corrosion. Approximately 175' of 3 strand nylon line has been added to ensure a adequate scope in different depths and weather situations. The nylon will stretch under a heavy strain cushioning the impact of waves or wind on both the boat and the anchor.

To anchor, select an area preferably with a flat bottom. Mud, sandy clay and firm sand afford the best bottoms for anchoring. Grassy bottoms often resist the anchor taking hold and end up pulling out grass and roots. Contrary to modern belief, you do not anchor while the boat is making headway, or moving forward. In fact, the bow of the boat should be brought slowly backward, while releasing the anchor until it hits the bottom. To "snub the line" means to stop its outward "pay" or movement. Usually the length of anchor line used should be 5 to 10 times the depth of the water depending on weather conditions. This ratio is called the "scope"; the minimum scope under average conditions is 7 or 8:1. If the scope is too short the anchor's efficiency is diminished. A longer scope cushions the shock load on the entire system. 9

Once a scope is determined sometimes it is difficult to know how much line to let out to reach the desired scope especially at night. One way to mark an anchor line that will identify the amount of line is to paint wide and narrow bands from about 50' to 150' in 10' intervals. The wide bands equal 50' and each narrow band would equal 10'. Distinguish each 50' band with a different color paint. This can be done with "see in the dark" paint. Simply tape each length for the appropriate band before painting it. After you have anchored, check your position with landmarks if possible. You need to continue to monitor these landmarks to make sure you are not drifting. Since anchoring can also be an emergency procedure, the anchor and line should be readily accessible. Check anchor locker to ensure an untangled anchor line.

Once anchored the anchor line must be secured to a strong tie such as a cleat.

Do not rely on the windlass brake to carry the anchor rode load.

Use a series of full turns and half-hitches around the cleat horn to prevent any line slippage or jamming. This is important as the scope may need to be adjusted over a period of time and you need swift access to the line.

For increased holding power in windy conditions, two anchors are sometimes set. If your primary anchor drags, you can run out your secondary anchor without picking up the primary one. The important thing is to lay them out at an angle. When setting two anchors, make sure they are fastened to separate strong ties such as cleats. This is done in case you need to adjust one later so the line must be accessible.

Note: In times of high waves a buoy on the rode works as a shock absorber and allows the vessel's bow to ride the wave crests without large strains being transmitted to the set anchor. These plastic foam buoys can be purchased at boating retail outlets.



TOWING

In case you find yourself aground or in need of a tow, or should you want to tow another vessel, keep in mind that you never use deck hardware or cleats to secure lines for towing!

Deck hardware is intended for mooring and anchoring, and is not designed to withstand the strain and pull of towing. Rather than tie the line to your cleats on deck, it is suggested that you tie a bridle by passing a line completely around the hull of your boat to avoid structural damage. When towing, always stand clear of a taut line, as any type of line breaking under stress can be extremely dangerous. The preferred line for towing is double-braided nylon, as it has sufficient elasticity to cushion shock loads. Move slowly and cautiously.

ADMIRALTY LAW

The Admiralty law sometimes referred to as the salvage law was founded primarily on English law fundamentals and basically says that a vessel distressed, in danger of flounder, if rendered assistance from a towing company or private agency, can be forced to relinquish a portion of the vessels' worth for the assistance received.

 **DANGER**

AVOID DEATH OR SERIOUS BODILY INJURY!
DO NOT USE DECK HARDWARE
INCLUDING CLEATS FOR TOWING
OR LIFTING PURPOSES.

NOTICE

IN THE EVENT YOUR VESSEL
IS IN DISTRESS
PRIOR TO ALLOWING
ANY TOWING COMPANY
OR PRIVATE AGENCY THE RIGHT
TO PASS A LINE TO YOUR VESSEL,
BE SURE TO ESTABLISH THAT YOU
DO NOT AGREE TO ANY SALVAGE RIGHTS.
ESTABLISH WITH THE CAPTAIN
OR OPERATOR
THAT YOU WISH TO BE ASSISTED
IN A CONTRACT BASIS
AND ESTABLISH A PRICE.
OF COURSE IN CERTAIN SITUATIONS,
YOU MAY NOT HAVE THIS OPTION.
USE YOUR BEST JUDGEMENT!



EMERGENCIES

Always be ready to help others on the water if possible, but do not take any unnecessary risks. Use equipment to save a life, but do not risk a life to save equipment. Consult earlier information in this manual concerning accidents, etc. Also, read other literature concerning on the water emergencies. Be alert and prepared!

FIRE

Fire aboard a vessel can spread quickly and can cause tremendous alarm among everyone. Most fires can be prevented by keeping the bilge free from oil and debris. Keep all equipment stowed and maintained in working order. Carry backup fire extinguishers on board. If something becomes a possible fire hazard, remove that possibility at once.

Never use water on gasoline, oil or electrical fires. When you dump water on an electrical fire you can be shocked since water conducts electricity.

Follow these instructions if a fire breaks out:

1. Fit everyone aboard with a life jacket. Turn off the ignition switch.
2. Try to keep the fire downwind. If the fire is to the stern, head the bow toward the wind. If forward, put the stern to the wind.
3. If the engine should catch fire, shut off the fuel supply. Usually there is a fuel tank access that you can crimp the fuel feed line.
4. Use a hand fire extinguisher. Make sure to point it at the base of the flames. Use short bursts and sweep the extinguisher side to side. Remember: (A 4 pound extinguisher discharges in approximately 20 seconds) These actions help prevent the fire from spreading to other parts of the boat. You can extinguish fires quickly if you act swiftly. Have a plan of action in motion in case a fire breaks out.

FIRST AID

Knowing first aid can save lives. A first aid kit and the ability to use it are important ingredients for the safety of a skipper's passengers, crew and vessel. Having confidence and competence in handling medical emergencies on board is a must for the skipper. Invest your time in a first aid course available at the American Red Cross.

CPR (BASIC LIFE SUPPORT)

If someone is seriously injured have someone call for help while the injured person is being attended.

Check for possible danger signs; loss of breathing, unconsciousness, severe bleeding and heartbeat. If you determine the individual is not breathing or unconscious place the victim on their back on a hard surface and do the following:

1. If unconscious, open the airway. Neck lift, head lift or chin head lift.
2. If not breathing, begin artificial breathing. Pinch the nose. Give 4 quick breaths. If airway is blocked, try back blows, abdominal or chest thrusts and finger probe until airway is open.
3. Check for pulse. Begin artificial circulation. Depress sternum. Fifteen compressions rate 80 per minute. 2 quick breaths. Continue uninterrupted until advanced medical support is available.



HYPOTHERMIA

Hypothermia is a condition where the body temperature decreases because the body can't generate enough heat to maintain its normal temperature. It can be serious and usually occurs where victims have been immersed in water (under 68 degrees) for periods of time. If you encounter a possible hypothermia victim call for help on the radio and get the person out of the water.

Symptoms are:

1. Shivering that if condition is advanced may stop.
2. Confusion, clumsiness or slurred speech.
3. Rigid muscles.
4. Semiconscious to unconscious.

Treat hypothermia by the following:

- Remove wet clothing.
- Monitor the victim's pulse and breathing.
- Rapidly apply heat to the body core by using blankets, naked bodies or warm water.
- Do not give the person any food or drink.
- Do not warm the arms and legs. Warming of these extremities can be fatal.

Follow up immediately with medical authorities!



CALIFORNIA AIR RESOURCE BOARD (CARB) LABEL

Your Regal boat may have a star shaped label affixed to the bow port hull side. It is located at the front of the state registration numbers. This label is part of the California Air Resource Board (Carb) SD/I rule. If your boat is operated in the state of California and/or bordering waters, this label **MUST** remain intact. The label shows that the engine installed as original equipment meets a currently approved California state regulatory emission level. See the example below which shows the current California ultra low 3 star label.



CALIFORNIA PROP 65

Proposition 65 relates to the state of California and is an additional requirement added to their Safe Drinking & Toxic Enforcement Act of 1986. Prop 65 basically summarized states that: “No person in the course of doing business shall knowingly discharge or release a chemical known to the state to cause cancer or reproductive toxicity into water or onto land where such chemical passes or probably will pass into any source of drinking water” and it goes on to say “ no person in the course of doing business shall knowingly and intentionally expose any individual to a chemical known to the state to cause cancer or reproductive toxicity without first giving clear and reasonable warning to such individual”

For more information, contact the California Office of Environmental Health Hazard Assessment at 916-445-6900 or <http://www.oehha.ca.gov/prop65.html>.

WARNING

A wide variety of components used on this vessel contain or emit chemicals known to the State of California to cause cancer and birth defects and other reproductive harm.

EXAMPLES INCLUDE:

- * Engine and generator exhaust
- * Engine and generator fuel, and other liquids such as coolants and oil, especially used motor oil
- * Cooking fuels
- * Cleaners, paints, substances used for vessel repair
- * Waste materials that result from wear of vessel components
- * Lead from battery terminals and from other sources such as ballast or fishing sinkers

TO AVOID HARM:

- * Keep away from engine, generator, and cooking fuel exhaust fumes
- * Wash areas thoroughly with soap & water after handling the substances above



FUEL SPILLAGE

The federal water pollution control act prohibits the discharge of oil or oil waste (such as from the sump bilge pump) into or upon the navigable waters of the United States or the waters of the contiguous zone. Violators are subject to substantial civil fines and criminal sanctions. A placard is normally found inside the engine hatch area or in the sump warning of overboard discharge of oil or oily waste.

ENVIRONMENTAL AWARENESS

There are numerous vessels operating on our waterways on a daily basis. Each boat has an impact on our environment. Boat operation habits, marine sanitation, and maintenance all play a role in a delicate battle to keep the ecosystem clean. Each of us has a role in doing our part as an environmentally conscious skipper to conserve our waterways.

The National Marine Manufacturer's Association lists their top ten of Eco-Boating Practices as follows:

1. Observe all regulatory agency policies regarding marine toilets.
2. If equipped with a holding tank, use marina pump-out facilities.
3. If used, make sure bottom paints are legal and ecosystem friendly.
4. Use only biodegradable cleaning agents.
5. Dispose of all garbage and litter on shore properly, not on the water.
6. Don't top off fuel tanks. Leave expansion room. Clean up spills.
7. Watch your wake and propeller wash.
8. Make sure your engines are well tuned and maintained.
9. Control your bilge water.
10. When fishing, practice the "catch and release" principle.



Auxiliary Equipment Operation

AUXILIARY COMPONENTS



Note: Equipment or vendors may change during a boat's life cycle as we are constantly upgrading our product line. Regal Marine Industries, Inc. retains the right to change vendors, equipment, specifications, component location, and other technical data at any time.

OVERVIEW

In addition to the main components and systems reviewed in Chapter 4 there are other auxiliary equipment components outlined here. To locate more detailed information for the auxiliary components refer to the appropriate manufacturer's owner's manual found in the owner's information packet. Also, further updated information may be available on the internet by using the proper name of the component and the Goggle® search vehicle.

Note: The equipment discussed and shown in this chapter is common to both the Grande Coupe and the Fly models.



INTERIOR EQUIPMENT

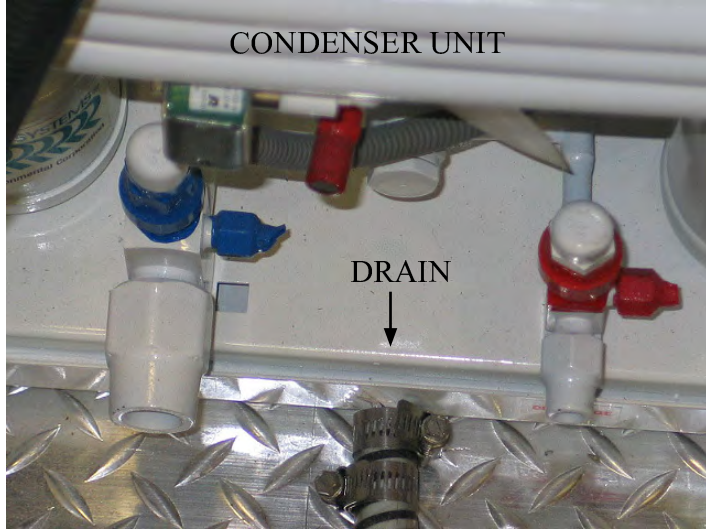

AIR CONDITIONER (TYPICAL)

To operate the air conditioning system:

1. Ensure the A/C seacock is opened.
2. Check the A/C sea water strainer for debris.
3. With shorepower (dockside) cord attached and energized activate the breaker at the AC distribution panel. This will start the A/C pump. Make sure water is seen at the thru-hull fitting. It may take a short period to cycle.
4. Locate the Elite control and follow the operating instructions as outlined in the A/C section in chapter 4.
5. If applicable, adjust the vents as needed for individual comfort.
8. Periodically, check the condensation tray drain for debris (see photo) and pour a measured amount of premixed AC line cleaner in the tray to purge the A/C drain line.
9. There is a return air filter located in the system. Once a month clean the filter by rinsing with water, rinse and air dry. Reinstall filter.

Read the A/C owner's manual for more information.



Auxiliary Equipment Operation

CARBON MONOXIDE DETECTORS

Carbon monoxide known as CO is indeed the silent killer. It is a by-product of combustion. CO is invisible, tasteless, odorless and is produced by all internal combustion engines, heating and cooking appliances.

The most common forms of CO on board vessels are petrol engines/generators and if applicable, propane heating and cooking devices. Note: Even though your vessels propulsion system is diesel based follow the CO precautions. Also, remember that a vessel moored next to you may be a CO poison contributor.

Never operate these devices when people are sleeping. A slight amount of CO in the human body over several hours causes headaches, nausea and symptoms close to food poisoning, motion sickness or flu. High concentrations can be fatal within minutes.

HOW THE SYSTEM WORKS

The CO detector uses a mini computer to measure and accumulate CO levels. Using the principle of “time weighted averaging” the detector monitors CO concentrations, temperature, humidity and time to calculate COHb levels. To explain COHb, our bodies prefer to absorb CO to oxygen and COHb is the absorbed ratio stated in a percent.

If the detector senses high levels of CO the alarm will sound in a few minutes. If lower levels are sensed, the detector will accumulate the data and sound an alarm when the appropriate level is reached. Read and understand the CO owner’s manual in the information pouch.

To turn the CO detector system on:

1. Notice the CO breaker on the 12 volt main DC panel. It must be turned off in a two-step sequence. This is for safety purposes. The system should be always left ON. You must flip back the switch cover before you are able to deactivate the breaker.

The CO circuitry works to its best performance when continually activated plus it accords advanced warning when entering an area high in CO.

2. When power is applied to the detector, the power indicator (top) will flash on and off, followed by the (red) lower alarm indicator flashing off and on as part of a 8-14 minute warm-up period. The green (top) power indicator will indicate a solid green when the unit has reached correct operating temperature. Never operate a cooking device with the canvas up or the cabin door completely closed to prevent CO concentration build-up

CO DETECTOR



3. The test cycle should be activated frequently. Simply press the button. When it is released, the (top) power indicator will flash off and the lower indicator light will flash on. Then, the lower indicator will flash off and the upper indicator light will come back on. The top indicator light being on solid green indicates normal operation.

Refer to the CO detectors owner’s manual for an explanation of the test cycle indicators.

4. When an alarm sounds take action immediately. The danger alarm indicator flashes red and the horn beeps 4 times, pauses and repeats the cycle. This indicates a rate of 10% COHb has been reached.

- a. Operate reset/silence button.
- b. Call your emergency services (911)
- c. Immediately move to fresh air. Do not re-enter the vessel. until emergency personnel have arrived, aired the vessel out and the alarm is in a normal condition.
- d. After following steps a-c and your alarm reactivates within a 24-hour period call a qualified technician to inspect the vessel. Note that the CO detector will clear when the CO concentration has dropped below 70 ppm.



GREY WATER SYSTEM

If installed, the grey water system equipment collects all used water exiting from the shower sump pumps along with the galley and head sinks. The used water is stored in the ship's holding (waste) tank. This option is used in various locals where it is illegal to pump "grey" shower and sink water overboard. The automatic float switch pumps grey water to the holding tank.

Normally it would not require any special service unless there was blockage somewhere in the system or a hose leak developed in the system. Since more liquid in the form of grey water is being returned to the holding tank pay closer attention to the waste monitor panel. The holding (waste) tank may need to be pumped out more frequently.



Auxiliary Equipment Operation

DECK HATCH-TYPICAL

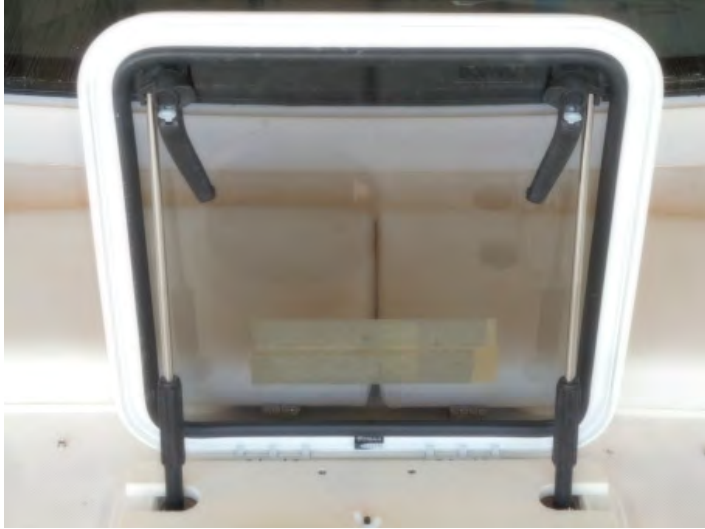

Most deck hatches feature a locked position. To lock the hatch first grab the handle and turn it so it engages the side of the seal ring as shown. Push the lock mechanism to engage the handle in the locked position.

To unlock the hatch pull the handle away from the seal ring (in line with adjuster) or 90 degrees from the locked position.

To open the hatch make sure the hatch is unlocked. Then push the rod up and lock at desired angle by turning the adjuster.

A screen is provided for cross ventilation and to protect against insects. Secure the screen by turning the tabs at a 90 degree angle to the screen framework.

Select hatches feature black-out privacy shades.





GRILL-COCKPIT

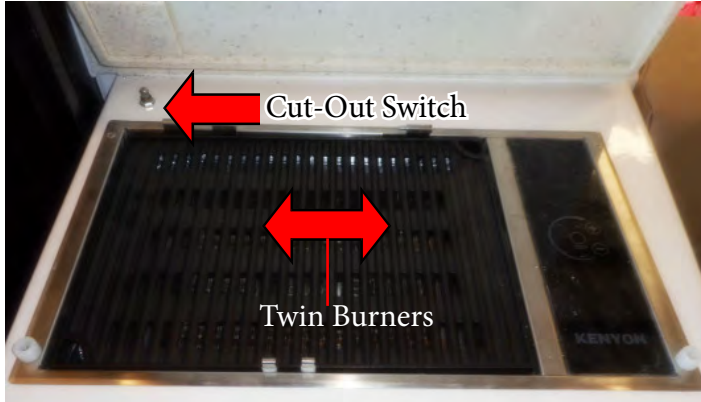

RANGE TOP CUT-OUT SWITCH

A cut-out switch shuts the power to the cockpit grill burners should a cooking fire develop. When the grill cover is installed over the grill the burner power is then interrupted. At that point the breaker on the main AC panel should be turned to the “off” position.

Always have the correct type portable fire extinguisher ready when cooking aboard the vessel.

Note: With day to day grilling always let the unit cool before recovering it.



WARNING

AVOID SERIOUS INJURY!
NEVER ALLOW SMALL CHILDREN
NEAR THE COOK TOP/GRILL!



WARNING

AVOID SERIOUS INJURY!
OBSERVE ALL SAFETY INSTRUCTIONS
WHILE USING THE COOK TOP/GRILL!



Auxiliary Equipment Operation

LIGHTING-TYPICAL

Your vessel features various styles of lighting such as cockpit, overhead, hanging locker, and reading types. Select lighting fixture requires specific bulb types and replacement procedures.

A great majority of newer lighting fixtures incorporate LED technology which is known for clear visibility, long service life, energy savings and temperatures cool to the touch.

LED lamp technology is made up of electronic clusters when coupled with “free” electrons produce light.

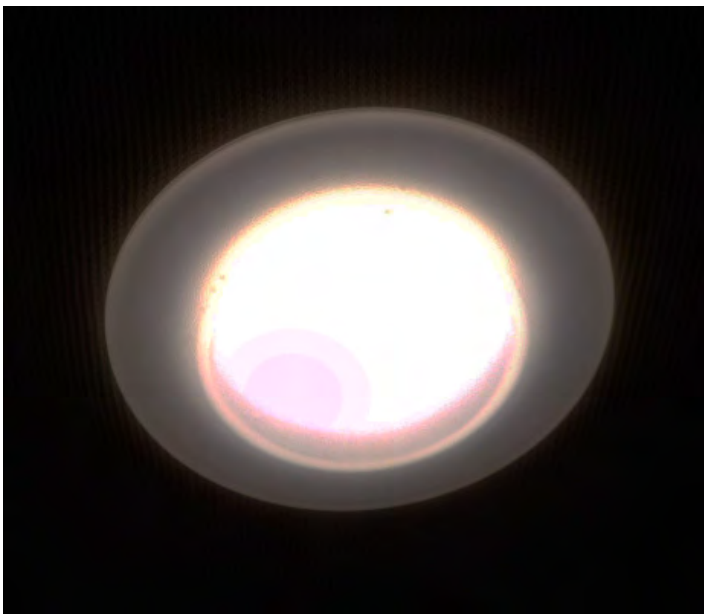

LED lighting output is measured in lumens versus the old technology know as watts. Most fixtures are marked with the unit’s lumen light output. A lumen is the measured brightness or light output.

One of the great features of LED technology is that these light clusters need no servicing such as changing bulbs like earlier lamps. In the event a lighting unit fails a new fixture can be ordered from your closest Regal yacht dealer.

MICROWAVE



The microwave features a touch pad and 1000 watts of cooking power along with convection, grill, and microwave functions.

Specifications include a 12.4” turntable. The cooking space measures 1.0 cubic foot.

Before using the microwave read and understand the vendor owner’s manual since the manual will afford the functions, safety, and maintenance features of the unit. To use any of the functions first *activate the microwave breaker* at the ship’s main AC/DC panel.

The convection function heats food similar to a traditional kitchen oven. You have the option to pre-heat or not.

The grill cycle uses the grill fixture which can be used on the turn table. Set the grill time as shown in the manual.



MONITOR-WATER/WASTE



Notice the key switch portion of the monitor. The key switch controls an overboard discharge pump (macerator) which can grind up the waste and send it through the hull bottom. Make sure the waste seacock is open and you are legal to pump overboard. Turn the macerator breaker on and then energize the monitor panel key switch. Be sure to turn the seacock off and secure it with a tie wrap after the pump-out cycle is completed as you can be fined if authorities find the seacock in an unlocked position.

To read either the fresh water or waste water monitor panel the breaker on the main DC panel must be activated.

The monitor is normally located inside the ship's AC/DC cabinet or may be located behind the starboard picture window on a trim panel.

The fresh water monitor displays the amount of potable water in the system. There are sensors located in the water tank that send a signal to the display panel when activated. Press the top portion of the toggle switch and read the gauge display.

The waste portion of the display shows the amount of waste water in the holding tank. There are sensors located in the waste tank that send a signal to the display panel when activated. Press the bottom portion of the toggle switch and read the gauge display.

This portion of the system needs to be monitored periodically to prevent the system from being over full which could cause equipment damage and/or a possible leak in the vessel.

If the waste system is determined to be full it can be emptied by connecting a marina pump-out hose to the waste fitting located on the deck. The pump out device will actually remove the waste much like a vacuum cleaner. This is the easiest way to eliminate the vessel's waste and be environmentally friendly while performing the task. An alternative method which can be used in International waters only is to pump the waste overboard using the waste seacock.



Auxiliary Equipment Operation

REFRIGERATOR-TYPICAL

OVERVIEW

Your refrigerator is designed to operate in the tough marine environment. It can withstand a heel angle up to 30 degrees for a short time which makes it very adaptable for marine use. A few tips:

1. The salon (upper deck) refrigerator uses AC/DC current switching automatically as needed. Turn on the breaker at the ship's AC/DC service panel before activating the refrigerator.
2. Unnecessary opening of the refrigerator door will increase power consumption.
3. Keep the inside of the unit clean and dry.
4. Remove any water that may collect on the shelf under the freezer compartment.
5. When leaving the vessel for extended periods of time turn the breaker off at the ship's service panel. Remove any food from the unit. Prop the door open slightly before leaving the vessel. This helps air out the refrigerator.
6. Note: The unit will keep food cold 5-6 hours without any DC power providing the food is chilled already.
7. It is important that the refrigerator compressor/condenser be well ventilated so cooler air can enter from the bottom and warm air can exit the top of the unit. Never block any of the ventilation grilles.

Note:

If installed, the refreshment center refrigerator (lower deck) uses 120 volts. The cockpit refrigerator utilizes 12 volts DC.



TYPICAL SALON DUAL VOLTAGE REFRIGERATOR



TEMPERATURE SETTING

Your refrigerator is equipped with a manually controlled infinitely-variable thermostat.

Turn the thermostat toward the higher numbers to raise the temperature and toward the lower numbers to lower the temperature and to activate the on-off switch. A slight spring resistance is noticeable at the on-off switch.

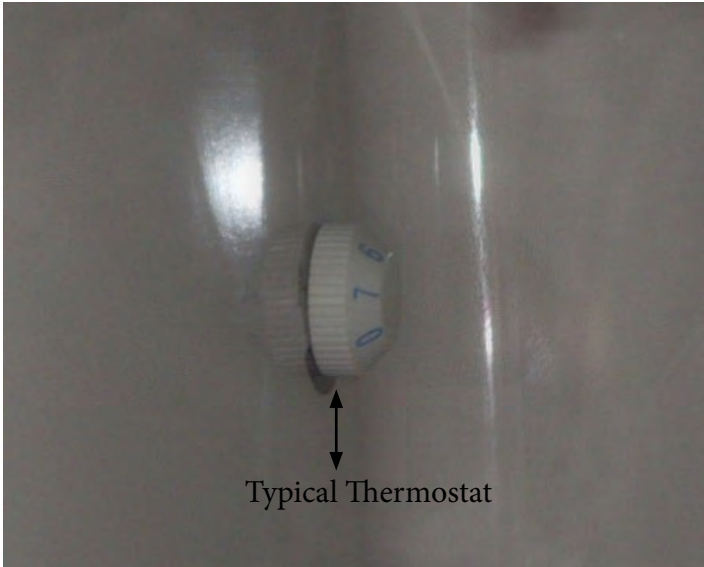

DEFROSTING

The refrigerator requires defrosting when the frost layer is around 1/8”.

To defrost do the following:

1. Turn the thermostat off.
2. Store the food and beverages from the refrigerator in an iced down cooler.
3. Do not use sharp metal objects to remove the accumulated ice. Let the refrigerator deice under normal cabin temperatures.
4. Restart the refrigerator after it is completely defrosted. Be sure to clean and dry the unit.
5. Empty the drip tray below the freezer compartment as often as needed in the defrosting cycle.

Normal Refrigerator Operating Sounds

Your refrigerator/ice maker combo features rigid foam insulated cabinets to provide high thermal efficiency and maximum sound reduction for its internal working components. In spite of this, the unit still may make some unfamiliar sounds.

Normal operating sounds may be more noticeable because of the unit's environment. Hard surfaces such as fiberglass floors have a tendency to reflect normal appliance operating noises.

Common refrigeration components, and a brief description of the normal operating sounds they make, are listed below.

Note: Your unit may not contain all of the components listed.

Compressor- The compressor makes a humming or pulsing sound during normal operation.

Evaporator- Refrigerant flowing through this unit may sound like boiling water.

Condenser Fan- May hear air moving through it.

Water Valve- At each cycle, a buzzing is heard.



Auxiliary Equipment Operation

Periods Of Non-Use

During extended periods of non-use take the following precautions.

1. If equipped turn off the breaker at the ship's AC distribution panel.
2. Turn the refrigerator to the "OFF" position at the power valve.
3. Raise the bin arm to turn the icemaker off.
4. Empty the refrigerator of all items. Clean the interior of the unit with a mild non-abrasive detergent and warm water solution applied with a soft sponge or soft cloth. Rinse with warm water and a soft sponge. For rust spots use Bon-Ami® or Barkeepers Friend Cleanser®
5. Prop the door open. The unit will manually defrost.



SEAT-HELM

The helm seat features an electric hydraulic mechanism which moves the captain's seat fore-aft and up-down to accommodate different body types and cruising options. The helm seat features a leaning post to gain extra height or additional standing room at the helm when maneuvering in close quarters.

There is a dual set of toggle style switches to the starboard side of the helm. The arrows on the switches depict the function. See the illustration on the right.

To add seat height using the leaning bolster lift the front of the helm seat upward. This permits the leaning bolster to rotate upward until fully extended. See the illustration below.



TYPICAL CAPTAIN SEAT SWITCHES



NOTE: Front Cushion Flipped Up For Increased Standing Room



Auxiliary Equipment Operation

STOVE



The salon galley mounted stove features 240 volt power and a ceramic cleaning surface. There is a safety switch back up system integrated into the wiring circuit. The unit offers 2 large size burners and a variety of temperature settings.

Be sure to read the vendor owner's manual regarding general operating and safety information before using the stove.

Note: Never install the stove cover over a hot stove burner surface. Allow sufficient time to cool down and during this time store the cover per the illustration above.



To operate the stove do the following:

1. Remove the solid surface stove cover by using the thumb hole and lifting upward. Make sure the helm seat is far enough forward.
2. Position the stove cover and install it in the track. This will now open the cut-out switch at the track and permit current to flow to the stove burner once the stove is activated.
3. Activate the stove breaker at Leg C (240 volts) on the main AC panel at the atrium stairway.
4. Use the stove top touch controls to heat burners to needed temperature.
5. After stove has cooled completely the cover may be reinstalled.
6. Read stove vendor owner's manual for cleaning and maintenance tips.



TABLE-SALON TYPICAL

TABLE-COCKPIT TYPICAL



SALON-DINETTE TABLE ADJUSTMENTS

COCKPIT TABLE ADJUSTMENTS

The salon-dinette table is designed to be moved as needed to provide dining and lounging capabilities.

1. To set up the table first find the bottom receiver and install in floor:

2. Set the table base where you want it.

3. For ease of installation set the table on the sofa with the table pedestal support facing up. Turn the upper table leg lock counterclockwise until the gap is large enough to accommodate the table leg diameter.

4. Install the table leg in the table pedestal support hole. Tighten the leg lock until secure.

5. Insert the table and table leg as an assembly into the floor receiver.

6. Check for stability.

1. Find the table leg in the aft seat storage.

2. For ease of installation set the table on a cushion with the table pedestal support facing up. Insert the table leg under the top of the table into the receiver. Note that there is a short and long leg.

3. Install the table leg in the floor receiver. Check for stability.



Auxiliary Equipment Operation

TV (LCD) MONITOR PRECAUTIONS

The following safety information applies to all LCD flat screen television monitors. Refer to the antenna switch information in Chapter 4 for the proper connection depending where the vessel is moored.

SAFETY INSTRUCTIONS



NOTICE

WHEN LEFT FOR EXTENDED PERIODS
TURN THE TELEVISION BREAKER
TO THE OFF POSITION
TO HELP PREVENT
POWER SURGES OR LIGHTNING DAMAGE.

NOTICE

IF TV FEELS COLD TO THE TOUCH
THERE MAY BE A SMALL FLICKER
WHEN IT IS ACTIVATED.
THIS IS NORMAL.

NOTICE

THE FLUORESCENT LAMP USED IN
THIS TELEVISION CONTAINS A SMALL
AMOUNT OF MERCURY.
DISPOSE OF THIS PRODUCT
IN AN ENVIRONMENTAL FRIENDLY
MANNER USING LOCAL GUIDELINES.

CAUTION

RISK OF ELECTRICAL SHOCK!
DO NOT REMOVE COVER
AT TELEVISION REAR.
NO USER-SERVICEABLE PARTS INSIDE.
REFER SERVICING
TO QUALIFIED PERSONNEL ONLY.

CAUTION

RISK OF EQUIPMENT DAMAGE!
IN FREEZING CLIMATES
REMOVE THE TELEVISION SET
FROM THE VESSEL.



VACUUM CLEANER SYSTEM-TYPICAL



The vacuum system is located in forward stateroom at the starboard wall of the berth. Included is a netted bag of hoses and various vacuum attachments.

SAFETY WARNINGS

1. This is a dry vacuum system. Do not use on wet surfaces.
2. Never operate the vacuum without filters and bags in place.
3. Use careful monitoring when children are around. Do not let the vacuum cleaner be used as a toy.
4. Do not try to repair the vacuum as the unit is sealed. Return the unit to InterVac or an authorized repair center for proper repairs.
5. Use only as described in this manual. Use only factory attachments and bags.
6. Do not use with any blocked openings. When the secondary filter becomes dirty, rinse in warm water or replace the filter. Filters must be completely dry before using.
7. Never drop or put any object into any opening.
8. Turn off the accessory breaker at the ship's AC panel to deactivate the vacuum cleaner.
9. Keep all body parts and clothing away from all moving parts.
10. Do not pick up anything that is burning or smoking such as cigarettes, matches, hot ashes or sharp objects. Do not use without dust bag or filters in place.

11. Do not attempt to operate the unit with a wet hose.
12. Do not store objects close to the vacuum unit.
13. Do not pick up flammable or combustible liquids such as gasoline, or use in areas where they might be present such as the bilge.
14. Do not step on the hose, nozzles or pull hard on the hose.

OPERATION

1. To operate the vacuum, the accessory breaker at the main ship's main AC panel must be turned to the "ON" position.
2. Lift the inlet cover on the vacuum unit.
3. Insert the hose cuff (one with the metal band) with a slight twist and the vacuum cleaner should start.
4. To remove, turn hose in either direction while pulling the hose toward you and the vacuum cleaner will stop.

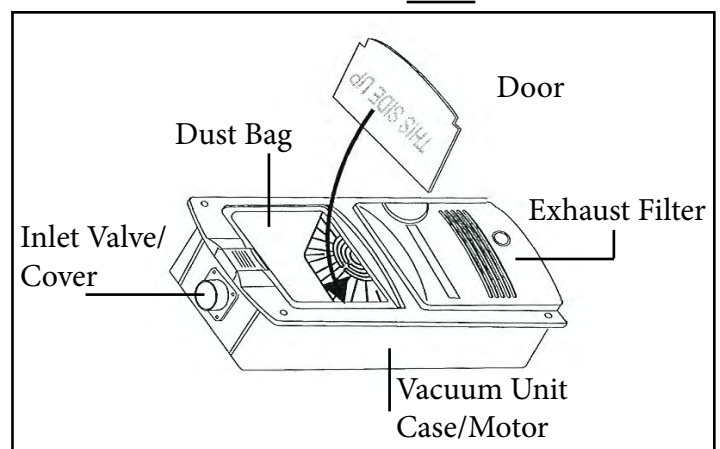

Note:

If the motor stops the thermal protector on the unit will reset automatically after about 1/2 hour. This is normal for the vacuum cleaner.



Auxiliary Equipment Operation



Insert Hose Cuff Here

If The Motor Stops Suddenly:

1. The most common cause is a clogged hose. Try to unclog the hose with a long object or by shaking the hose until the debris falls out.
2. The bag is overfilled and fine dust has clogged the bag.
3. The vacuum cleaning tools are clogged.
4. The motor (exhaust) filter is dirty and should be cleaned or replaced.
5. While the vacuum cleaner is being used keep the cushion up to provide additional air to the unit. This will help the unit from shutting down.

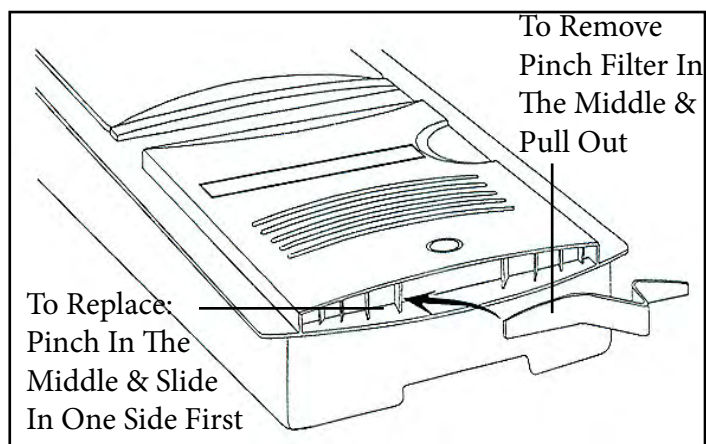

Replacing Exhaust Filter



EXTERIOR EQUIPMENT

ANTENNAE

The GPS/plotter antenna is located on top of the aft hard top. The antenna includes a built-in position fixing receiver. The GPS plotter features a filter that compensates for the rolling motion of your boat for clearer course and speed information. The antennae are protected by individual plotter breakers.



UNDER DECK ANTENNAES SHOWN

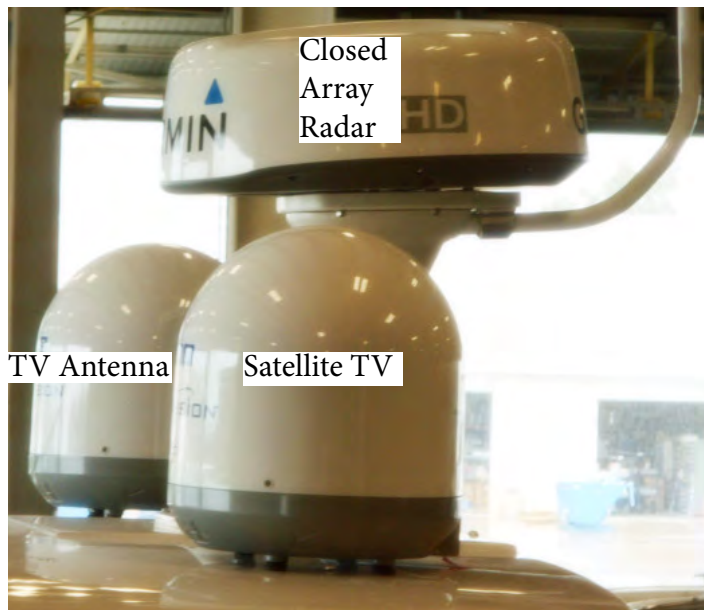

TYPICAL ANTENNA LOCATIONS

The electronics installed on your yacht are NEMA 2000 compatible which permits system components to share information with other marine-network compatible devices. Refer to your GPS/plotter owner's manual for further information.

Be aware of the vessel's bridge clearance specifications to avoid equipment/vessel damage due to impacting a bridge structure since a great portion of the antenna/receiving equipment is mounted on the hard top. Remember that the masthead light on the hardtop can be lowered if needed.

The VHF radio uses a whip style fiberglass antenna which is "trimmed" to provide the best output and reception. The TV antenna mounted on the hard top is shaped liked a saucer.

The satellite weather antenna is now located under the forward deck.

For further information on antennas refer to each vendor's owners manual.



Auxiliary Equipment Operation

BILGE PUMP/FLOAT SWITCH-TYPICAL

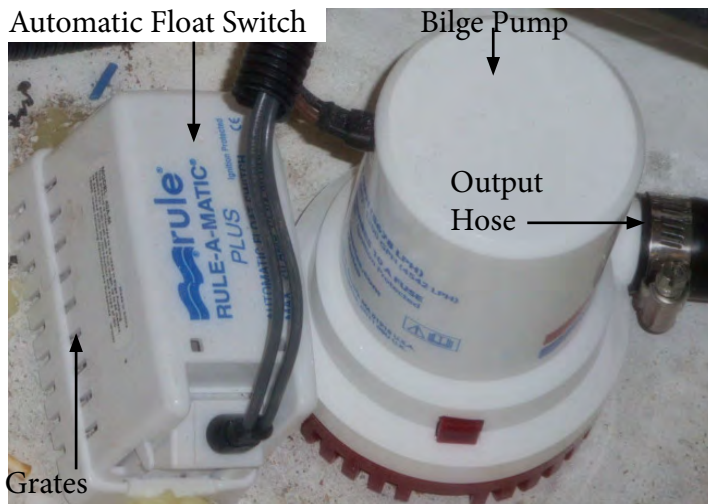

Your Regal yacht features bilge pumps and float switches in the sump (bilge) and forward cabin (selected models). They are operated through the helm switches. There are separate switches marked forward and aft bilge pumps. In the “off” position both switches are connected into the automatic float switch. In this “auto” position if the boat takes on water, the bilge pumps will activate and pump excess water overboard. The switch will light up when activated.

Periodically check the grates for debris and spray the units down with water. Make sure a steady stream of water exits the through hull fitting indicating the entire output hose system from the bilge pump itself is debris free.

Monitor your helm bilge pump switch icons periodically during your cruise. If one of the icon appears the bilge pump circuit is energized. Stop the vessel and shut down the engines. Check the hull side bilge pump discharge. If water is exiting investigate the cause of the problem. Make needed system repairs before restarting your cruise.



BOTTOM PAINT

As a factory option two coats of bottom paint are applied to your vessel. This product provides top-of-the-line antifouling protection. It contains the highest percentage of croupous oxide to aggressively combat even the worst tropical conditions. This product will help reduce annual hull maintenance.

The hard epoxy base produces the most durable finish for long lasting performance. If your vessel is left in the water the paint provides effective year round service.

Periodically check the bottom of the boat for growth. The vendor recommends scrubbing the bottom with a soft brush to remove anything from the antifouling surface. This scrubbing is particularly important with boats that are idle for extended periods.

Note: When touching up the bottom with epoxy paint wait at least 3 days before relaunching the vessel. On older models always leave at least 1 1/2" between any metal objects including anodes and the bottom paint to help prevent electrolysis. On later models there is a shim that assures the anode is a safe distance from the paint. These models can be painted right up to the anode edge. See the illustration.

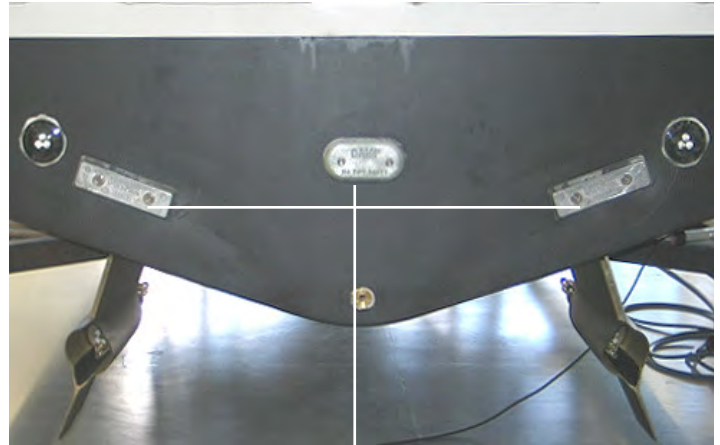

Typical Ocean Trac Bottom Using Shims Around Anodes

NOTICE

TO PROTECT AGAINST GALVANIC CORROSION
DO NOT USE BOTTOM PAINT ON ANODES.



Auxiliary Equipment Operation

CHAISE LOUNGE-FORWARD DECK

The forward deck features a chaise lounge with multiple reclining positions. A cabana option provides sun shade properties.

Note that the chaise lounge/foredeck sunpad must be used only when the boat is stopped to avoid anyone falling overboard.

Make sure the cushions are secured.



FORWARD SUN LOUNGE DOWN POSITION



	WARNING
AVOID SERIOUS INJURY OR DEATH DUE TO FALLING OVERBOARD! DO NOT OCCUPY THE DECK SUN PAD WHILE BOAT IS MOVING.	



DOOR-TRANSOM

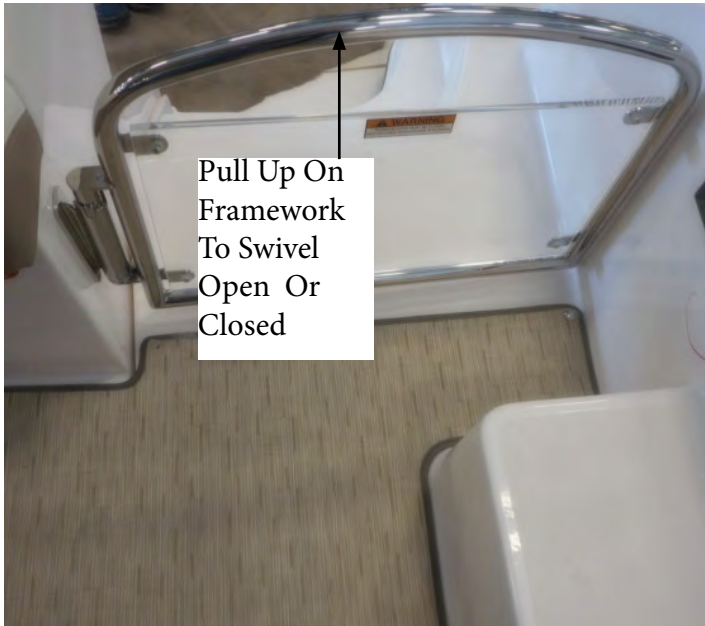

To open the door (gate style) pull up on the framework until the door hinge releases and swivels to an open detente position.

To close the door pull up on the framework until the door hinge releases and swivels to a closed detente position which will be locked . Double check for locked door by pushing on it from inside the cockpit.



WARNING

PREVENT SERIOUS INJURY OR DEATH
FROM FALLING OVERBOARD!
KEEP THE TRANSOM DOOR
CLOSED AND SECURED WHILE
VESSEL IS IN MOTION!



Auxiliary Equipment Operation

ELECTRONICS-GENERAL

Your yacht features several electronic components matched for compatibility. Manuals for each of the electronic components should be referenced for specific detailed operations. These manuals are part of the customer information packet.

Going through each piece of electronics while at the helm with the manual will greatly decrease the learning curve time.

Note: As an integral part of upgrading our product line Regal reserves the right to change specifications, components, locations, and vendors at any time.



FENDER CLIPS

The fender clip option features receivers integrated into the boat deck and quick release pins. The quick release pins attach to fenders with lines so they are ready to assist the crew as needed. When the vessel approaches a mooring the quick release pin with fender is attached to the receiver and pushed into place. This will help protect the boat from dock “rash” which could damage the rub rail or other boat parts. When leaving the dock the pins feature a quick release mechanism which detach easily allowing the fender and clips to be stored.



FENDER CLIP
RECEIVER



FENDER CLIP RE-
LEASE PIN



Auxiliary Equipment Operation

FIRE EXTINGUISHER- AUTOMATIC



OVERVIEW

The Fireboy automatic fire extinguishing system is located in the bilge at the forward engine bulkhead. See the illustration. The system uses an environmentally friendly agent FE-241 which has been approved by the EPA to replace the old Halon agent. This system is formulated only for use in the engine space or bilge of your vessel. FE-241 is to be used with gasoline fuel systems only since the agent will not “stall” diesel engines. This could cause a fire to re-flash.

OPERATION-AUTOMATIC

Fireboy systems are not nor are they intended to be explosion suppression devices. Boat owner's still need to take normal precautions for checking fumes and using blowers.

Read the information in chapter 4 regarding the dash installed portion of the fire extinguisher system. When the system actuation starts you may hear a loud sound similar to that of small arms fire, followed by a rushing air sound.

The system will show actuation whenever the ignition key is ON and the indicator light is OFF. The actual actuation time when a fire occurs is dependent on the severity of the fire.

When the automatic fire extinguisher activates **IMMEDIATELY SHUT DOWN ALL ENGINES, POWERED VENTILATION (BLOWER), ELECTRICAL SYSTEMS AND EXTINGUISH ALL SMOKING MATERIALS. DO NOT OPEN THE ENGINE COMPARTMENT IMMEDIATELY!**

Allow the agent to “soak” the compartment for a period of time and wait for hot metals and any fuels to cool before inspecting for the fire cause. Premature opening of the engine compartment allows an in-rushing of oxygen and could result in a flash-back. When the engine compartment is opened have approved portable fire extinguishers ready to use.

OPERATION-MANUAL

If a fire has started in the engine compartment where the Fireboy is located, **DO NOT WAIT FOR AUTOMATIC ACTIVATION.** Release the system manually. Close any opened hatches leading to the engine compartment, shut down all forced ventilation devices, engines, generators and electrical components. Remove the safety pin from the “Fire” T-handle, and pull T-handle firmly and release. A loud “rushing” or air” sound will be heard. Complete discharge will take several seconds. **DO NOT OPEN THE COMPARTMENT IMMEDIATELY!** Keep the compartment closed for a period of time sufficient to allow the agent to soak all areas of the protected space. This allows hot metals to cool.



Premature opening of the compartment could cause a re-flash. When opening the engine compartment for inspection have hand held portable extinguishers ready. Inspect the pressure gauge and system before and after each outing. Refer to the maintenance chapter for maintenance on your fire extinguisher system.

The illustration opposite shows the actuator not discharged at the top and one which has been discharged at the bottom.

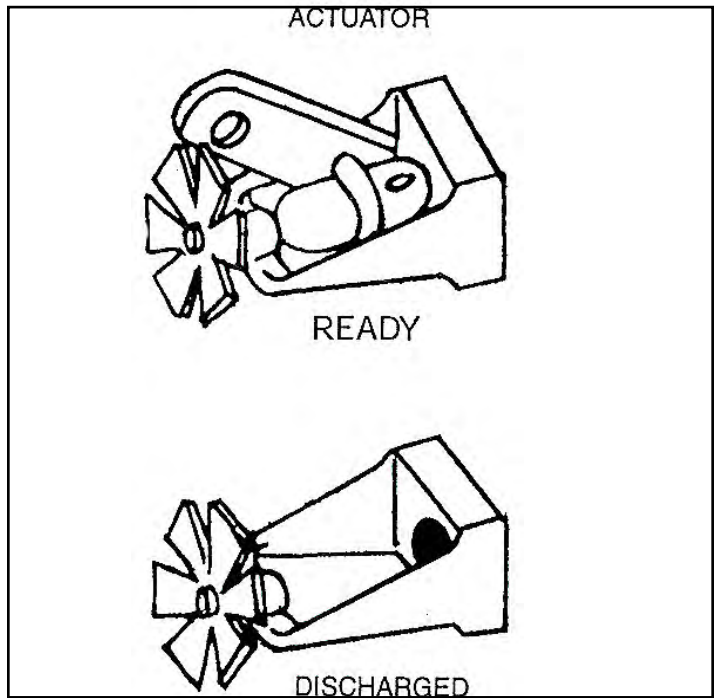

Typical Portable Fire Extinguisher



Portable fire extinguishers may be found in various cabin and cockpit lockers. On select yachts, a label may be present on the exterior locker doors identifying portable fire extinguisher locations. Know the location of portable fire extinguishers and perform periodic

inspections.



! WARNING

AVOID SERIOUS INJURY OR DEATH!
DO NOT BREATH FUMES OR VAPORS
CAUSED BY A FIRE AS THEY ARE
HAZARDOUS AND TOXIC.

! WARNING

AVOID SERIOUS INJURY OR DEATH!
ACCIDENTAL DISCHARGE COULD OCCUR
DURING HANDLING, INSPECTION,
OR WORKING IN THE ENGINE
COMPARTMENT.
WEAR EYE PROTECTION
AT ALL TIMES!



Auxiliary Equipment Operation

GENERATOR-DIESEL-TYPICAL

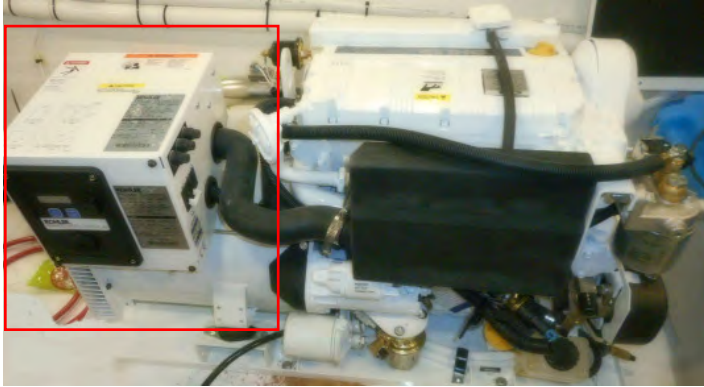

OVERVIEW

As standard equipment a diesel generator is featured on your yacht.

Current generators are more powerful but yet more compact in size. They run at a slower rpm for longer life. Today domestic generator is rated at 11 kw (120-240 volts, 60 hertz) It meets current EPA, CARB and CE emission requirements.

Detailed maintenance information can be found in the generator operating manual.

For general generator information see chapter 4 of this manual.

OPERATION

Perform the following inspections and checks before each startup, as designated, and at regular intervals as noted in the service schedule.

1. Air Inlets- Check for clean and unclogged air inlets.
 2. Air Shrouding- Ensure the enclosure is securely fastened and positioned correctly.
 3. Battery- Check for proper electrolyte level. Make sure all battery connections are secure.
 4. Coolant Level- Check the reservoir for proper levels.
 5. Exhaust System- Check for exhaust leaks and blockages. Check the silencer and piping condition and check for tight exhaust component connections. Inspect the exhaust parts (exhaust manifold, catalyst, exhaust hose, hose clamps, silencer and outlet flapper) for cracks, leaks and corrosion.
- Check hoses for cracks, softness, dents, or leaks. Replace as necessary.
 - Check for corroded or broken metal parts. Replace as necessary.
 - Check for loose, missing or corroded hose clamps. Replace or tighten the hose clamps and hangers as needed.
 - Check that the exhaust outlet is unobstructed.
 - Visually inspect for exhaust leaks (blow-by). Check for carbon or soot residue on exhaust parts which indicate an exhaust leak. Seal leaks as needed.



HARD TOP-(TYPICAL SHOWN)



The hard top features a reinforced FRP grid which provides a stable mounting platform for radar and various aftermarket components. It provides shade and protection from the elements.

The hard top area features ceiling lighting which is energized from the cockpit aft panel or from the helm. There is an access area integrated into the ceiling for routing wiring.

The all weather enclosure features a sliding door w/locking mechanism and horizontal sliding windows. The tempered glass is tinted and forms a complete weather-tight enclosure.



Hardtop-Front View



Auxiliary Equipment Operation

HATCH-ENGINE FORWARD OPENING

The engine hatch provides easy access for periodic bilge and equipment inspections. Use the ladder and walk-way to access the bilge from the day hatch. Be careful not to slip while climbing the ladder rungs especially if you were working around the engines. Your feet may have picked up some oil deposits or lubricants from engine components.

The engine compartment (bilge) lights can be accessed at the port aft cockpit lighting panel. Also, additional overhead lighting is available at the engine area by activating the overhead and courtesy light switches on the same panel. All light switches are individually protected by circuit breakers.

Since the hatch is electric and forward facing it is easiest to access the engine compartment from the aft to check engine, IPS drive unit and generator fluids.

The engine hatch uses a single heavy duty electric-hydraulic ram to operate up and down. The hatch switch control is found at the port cockpit lighting panel.

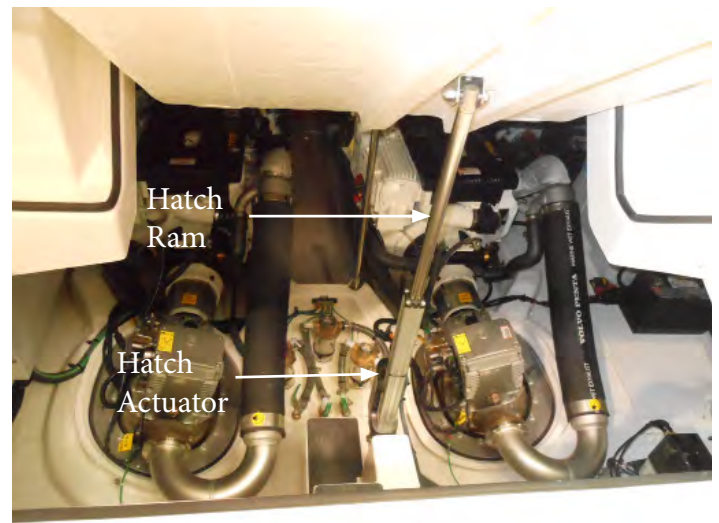

Typical Hatch



HEATER-HOT WATER

To initially fill the hot water heater, ensure the boat's fresh water tank is full. When the tank is full water will be seen at the deck vent. At the DC side of the main ship's AC/DC panel, turn the fresh water pump to the "on" position. Make sure the water heater is full of water by opening a hot water faucet until a steady stream flows out. With the generator running or the shore power connected, switch on the hot water heater at the AC side of the ship's service panel. The heating element will now begin to heat the hot water tank.

Should the hot water heater reset button need to be activated on older heaters, turn off the hot water breaker at the AC side of the main control panel. Then remove the panel cover to expose the reset button. Press the red reset button. On newer models there is a round access port on the rear panel to reach and reset the breaker.

Should the need arise there is a drain valve located at the rear of the heater. Always turn the hot water breaker to the "off" position before opening the drain valve. Make sure the water is cold before attempting to open the valve. The valve runs through the shower sump pump and then overboard. Never try to adjust the thermostat or open the drain valve before turning off the AC breaker.



CAUTION

TO AVOID POSSIBLE BODILY INJURY DUE TO ELECTRICAL SHOCK DO NOT TRY TO OPEN UP THE HOT WATER TANK COMPONENTS WHILE THE AC POWER IS ACTIVATED.
TURN HOT WATER BREAKER OFF AT THE MAIN AC PANEL.

NOTICE

TO AVOID EQUIPMENT DAMAGE DO NOT TURN ON THE HOT WATER BREAKER WITHOUT THE WATER HEATER BEING FULL. DAMAGE TO THE HEATER ELEMENT WILL OCCUR.



CAUTION

TO AVOID POSSIBLE BODILY INJURY DUE TO HOT WATER, BE SURE TO CHECK THE WATER TEMPERATURE BEFORE USING IT.



Auxiliary Equipment Operation

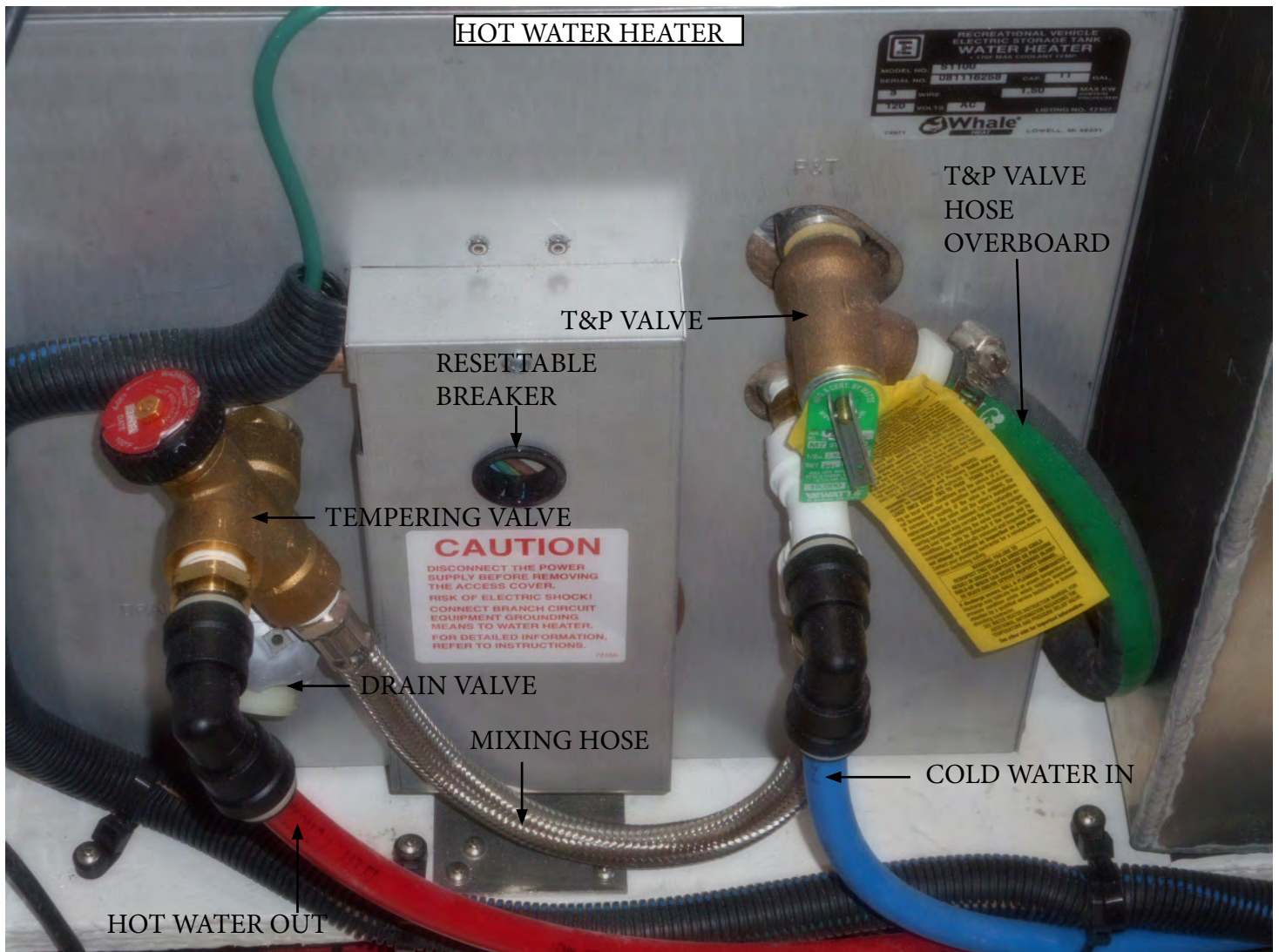

The hot water heater features recirculating ability to keep water warm during cruising. This is accomplished by a set of hoses connected between the hot water tank and the circulating engine water pump.

Engine coolant runs through a heat exchanger keeps the tank water warm when the engines are running through the use of a tempering valve (shown above). The tempering valve is factory set to ensure the hot water temperature in the system not to exceed 125 degrees at all times. As hot water enters the water heater it is mixed with cold water at the mixing valve to the pre-determined safe temperature.

There is no service needs for the tempering valve.

To protect the water heater itself from overheating there is a T & P valve installed on the right back side (see illustration above). This valve normally assumes a closed position. Should overheating occur the valve opens up and the hot water flows overboard. Should this happen the breaker at the main AC panel should trip. Investigate the problem or call a marine professional.



HIGH WATER ALARM-BILGE

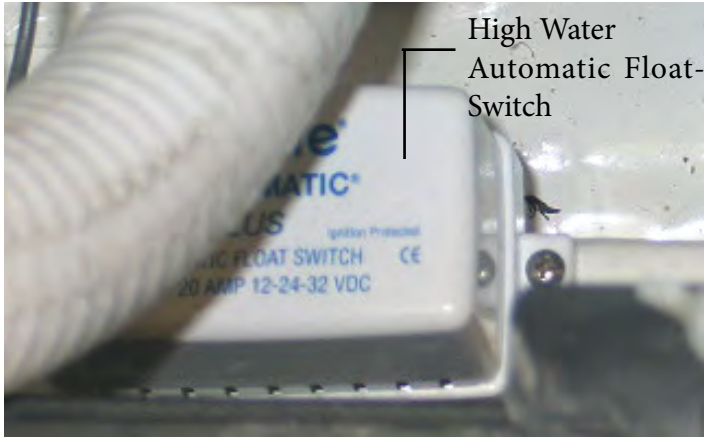

The high-water alarm warns the skipper of a possible emergency in the bilge area. There is an automatic float switch installed in the bilge. If the water rises over a predetermined level the bilge float switch sends a signal to the helm mounted alarm. This sump float switch normally is elevated from the position of the automatic bilge pump switches.

If the alarm sounds bring the vessel back to an idled position in neutral and turn off the engines. Open the engine hatch and find the cause of the problem.

Possible causes are:

1. Engine or generator hose leak.
2. IPS gasket leak between hull and drive.
3. Mufflers or exhaust hose leak.
4. Hull leak due to striking an object.
5. Water or waste tank leak.

6. Seacock leak.
7. Heat exchanger leak.
8. Transducer or underwater light leak.
9. Water heater tank or heat exchanger hose leak.



Auxiliary Equipment Operation

MARKERS FOR SLINGS -TYPICAL

Sling markers are located on the forward and aft deck near the rub rail. These markers provide a safe location to locate straps to lift the boat. Failure to use marked sling marker locations could cause damage to the boat structure.

When lifting the vessel close all doors, hatches and portlights. Make sure the spreader bars are adjustable enough to be wider than the sling beam area. This will allow the slings to hold the weight of the boat properly without forcing the boat structure inward. Make sure there is no pressure on the rub rail or swim platform wings. Always use a flat wide belt-style straps as they distribute and hold the boat weight in a more supported fashion. Do not use the cable-style straps since they may cause hull or rub rail damage. See the notice below and the information in the technical drawing section.

NOTICE

BOAT OWNER-LIFT OPERATOR

Before lifting boat place a fender or block between strap and hull just under the swim platform side wing (Both port and starboard) to relieve strap pressure on wing when lifting boat. When fender or blocking is positioned correctly strap will not put pressure on side wing when full weight is applied.

FAILURE TO FOLLOW THE ABOVE INSTRUCTIONS MAY CAUSE FIBERGLASS DAMAGE WHICH IS NOT COVERED UNDER THE REGAL LIMITED WARRANTY.

REFER TO THE DRAWING IN THE TECHNICAL SECTION FOR FURTHER INFORMATION ON BLOCKING.

NOTICE

AS A SAFETY PRECAUTION, WHEN THE BOAT IS LIFTED, TIE A LINE BETWEEN BOTH STRAPS TO PREVENT THE STRAPS FROM MOVING FORWARD OR AFT.

NOTICE

TO AVOID POSSIBLE FIBERGLASS DAMAGE, SET VESSEL FOR EXTENDED STORAGE ON A FACTORY APPROVED AND ADJUSTED STEEL CRADLE. NEVER USE BLOCKING TO SUPPORT THE VESSEL'S HULL BOTTOM.

TYPICAL AFT SECTION



TYPICAL FORWARD SECTION





OIL CHANGER

As optional equipment an oil change system is installed on the forward bulkhead of the engine room. It is designed to remove crankcase oil from two engines and a generator in diesel vessels. Also, the unit refills each crankcase oil pan with fresh oil through a system of hoses and an integrated pump.

Note: This unit does not drain or refill the transmission housing because these engines use a separate type fluid for the transmission.

The oil change system is housed in a fire retardant, high impact, high gloss case. The pump is solid brass with a special self-priming type impeller which pumps instantly whether in the drain or fill mode.

Power is supplied through the vessel's 12 volt DC system. There is a 20 amp breaker found on the DC distribution panel which is located on the forward engine bulkhead. It protects the system against overloads.

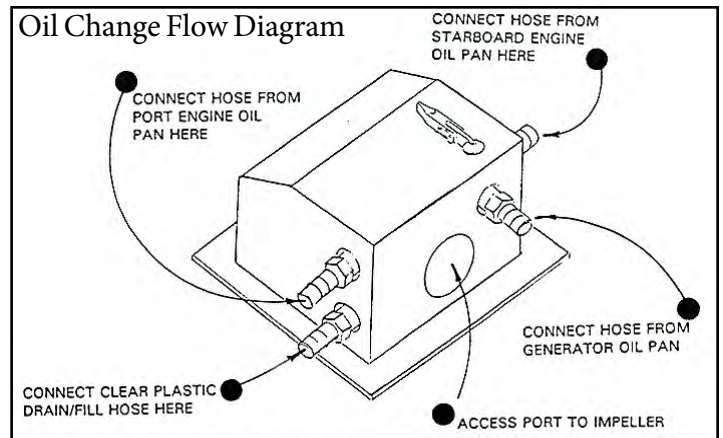

START-UP PROCEDURES

When starting the system for the first time, air will be in all of the lines. To prevent pump and or system damage follow the procedure outlined below:

1. Insert the PVC wand of the Drain/Fill Hose into a container holding a small amount of fresh oil.
2. Release the fail-safe lock device on the Pump/Motor Unit valve handle and direct the arrow-shaped tip to "Starboard".
3. Flip the motor control switch to the "Fill" position. The pump will start immediately and you will see the oil moving through the clear plastic tubing toward the Pump/Motor Unit. You will hear a noticeable change in sound (speed) of the pump motor when oil enters the pump.
4. Continue to operate the pump for 5 to 10 seconds after pumping action begins, then return the Pump/Motor switch to the "OFF" position and secure the oil fill cap.
3. Loosen the oil filler cap on the engine or remove the dip stick to allow air to enter the crankcase.
4. Release the fail-safe lock device on the Pump/Motor Unit valve handle and direct the arrow-shaped tip to "PORT ENGINE".





Auxiliary Equipment Operation



CAUTION

AVOID EQUIPMENT FAILURE!
IF OIL DOES NOT MOVE QUICKLY
THROUGH THE CLEAR TUBING
TOWARDS THE PUMP, TURN THE
SWITCH TO THE OFF POSITION,
ELEVATE THE CLEAR TUBING AS IT
NEARS THE ENTRANCE OF THE PUMP,
THEN FLIP THE SWITCH TO THE FILL
POSITION AGAIN.

This will lubricate the pump and insure a good starting vacuum.

Run the engine to be drained until it reaches 140 degrees. This will insure that the oil can be removed easily. Shut the engine down and allow ample time for the recirculated oil to return to the oil pan.

DRAINING THE PORT ENGINE

1. Warm engine to at least 140 degrees and turn the key off.

2. Insert the PVC wand of the drain/fill hose into an environmentally friendly waste container since you are responsible for disposing of waste properly.

5. Flip the motor control switch to the "DRAIN" position. The pump will start immediately. You should hear a noticeable change in the sound (speed) of the pump motor when the used oil enters the pump.

6. Continue to operate the pump until there is a noticeable change in the sound (speed) of the pump motor, which is an indication air is being drawn into the crankcase oil hose and the crankcase is now empty. The oil drain rate is about one gallon per 22 seconds.

7. Return the pump motor control switch to the "OFF" position when the crankcase is empty and place the fail-safe switch in the "OFF" position.

DRAINING THE STARBOARD ENGINE

1. Repeat each of the steps outlined in "Draining the Port Engine" after switching the arrow-shaped tip on the valve handle to the "STARBOARD ENGINE".

2. Flip the motor control switch to the "DRAIN" position.

3. Once the crankcase is emptied, return the pump motor control switch to the "OFF" position and place the fail-safe switch to the "OFF" position.

DRAINING THE GENERATOR

1. Repeat each of the steps outlined in "Draining the Port Engine" after switching the arrow-shaped tip on the valve handle to the "GENERATOR ENGINE".

2. Flip the motor control switch to the "DRAIN" position.

3. Once the crankcase is emptied, return the pump motor control switch to the "OFF" position and place the fail-safe switch in the "OFF" position.



FILLING THE ENGINES

Note: If you are using this unit for the first time to fill the engine crankcases be sure to read and follow the information in the “START UP section.

1. Before attempting to fill an engine, make sure the engine has been completely drained or is in need of a measured amount of additional oil. **DO NOT OVERFILL!**

2. Determine the type and the amount of oil recommended by the engine manufacturer for each engine.

Remember 4 quarts = 1 gallon

3. There are two commonly used methods to determine when the proper amount of oil has been delivered to the engine.

Pre-measured Method- this method requires the operator to set aside a known quantity of oil prior to filling. For example, if the engine requires 6 quarts of oil, the operator may want to pump from a gallon container, adding 2 additional quarts as the container empties.

Timed Method- the timed method is used when pumping from a container of unknown capacity or a reservoir. The flow of oil through the system varies primarily with the viscosity and temperature of the oil.

Under normal conditions the system pumps 4 quarts of 40 weight oil in approximately 90 seconds. Filling time is a function of several factors, including the oil temperature and weight. Oil (40 weight) at 85 degrees F. pumps about 20% faster than the same oil at 75 degrees F.

Note: Fresh oil should be 75 degrees F. or warmer before pumping.

FILLING THE PORT ENGINE

1. Loosen the oil filler cap on the engine or remove the dip stick to allow air to enter the crankcase.

2. Insert the PVC wand of the Drain/Fill Hose into a container of fresh oil.

3. Release the fail-safe lock device on the Pump/Motor Unit valve handle and direct the arrow-shaped tip to “PORT ENGINE”.

4. Flip the pump motor switch on the X-Change-R to the “FILL” position. The pump will start immediately and you will observe the oil moving through the clear tubing toward the Pump/Motor Unit. You should hear a noticeable change in the sound (speed) of the pump motor when oil enters the pump.

5. Continue to operate the pump until a measured amount of oil has been pumped into the engine’s crankcase. Fresh oil is pumped at the rate of about one gallon each 90 seconds.

6. Flip the pump motor control switch to the “OFF” position when the oil pan nears its filled capacity and check the proper oil level with the engine’s dipstick. If filling is completed, place the fail-safe switch in the “OFF” position.

Note: If you have an over-filled engine, you may simply flip the motor control switch to the “DRAIN” position for a few seconds to remove the extra oil.



Auxiliary Equipment Operation

FILLING THE STARBOARD ENGINE

1. Repeat each of the steps outlined in “Filling the Port Engine” after switching the arrow-shaped tip on the valve handle to the “STARBOARD ENGINE”.
2. When the oil pan nears its filled capacity, flip the pump motor control switch to the “OFF” position and check the proper oil level with the engine’s dipstick. If filling is completed, place the fail-safe switch in the “OFF” position.

FILLING THE GENERATOR

1. Repeat each of the steps outlined in “Filling the Port Engine” after switching the arrow-shaped tip on the valve handle to the “GENERATOR” engine.
2. When the oil pan nears its filled capacity, flip the pump motor control switch to the “OFF” position and check the proper oil level with the engine’ dipstick. If filling is completed, place the fail-safe switch in the “OFF” position.



OVERBOARD DISCHARGE PUMP (MACERATOR) TYPICAL

The overboard discharge pump (macerator) can be used to pump out the holding tank in international waters. When the monitor panel key is energized to the full start position, the macerator engages to pump the tank waste overboard. Again, make sure it is legal to pump the waste overboard before you start the operation. Also, open the waste seacock located in the sump. The pump can be disconnected from the 2 union fittings that hold it for maintenance purposes.

The pump is rated for 40 minutes continuous operation. Do not flush paper or feminine hygiene products into the waste system. Keep toilet tissue usage to a minimum. Do not use bleach or toilet cleaners in the waste system. Use only maine approved products. Rinse and flush the holding tank after each pump out. This will dilute any residual waste, and help prevent blockage and reduce odors.

IN-LINE WASTE VENT FILTER

Normally found in the bilge near a through hull fitting is a long cartridge style filter installed in-line at the waste tank vent hose. This filter removes waste odor from the system while still permitting methane fumes to escape via the hull side.

The waste filter is not serviceable. The manufacturer recommends that it be replaced each year.

Typical Waste System In-Line Filter



FRESH WATER & WASTE MONITOR WITH OVERBOARD DISCHARGE

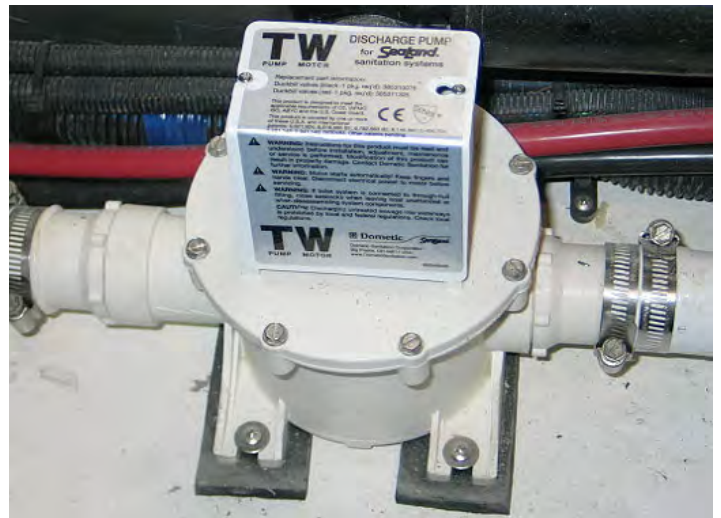

TYPICAL OVERBOARD DISCHARGE PUMP

The impeller grinds up the waste as it passes through the macerator. On the macerator shown above the system is protected by a 10 amp breaker located at the main DC distribution panel.



Auxiliary Equipment Operation

PRESSURE PUMP-FRESH WATER

Your vessel features a variable speed fresh water pressure pump. The variable speed allows for additional water flow at peak times such as using the forward and aft showers at one time. It is important not to operate the pump unless there is water in the fresh water tank. The pump is controlled by a breaker on the main DC control panel. Energizing the switch allows the pump to build the water pressure in the distribution lines to 35 psi's.

When the pump reaches a level of 35 psi the pump should automatically shut off. If the system drops below a certain pressure then the variable speed pump will restart. If the pump cycles on and off with no water being used, a leak in the water system is likely.

Periodically remove the water inlet filter and clean it. Additional filters can be ordered through your Regal yacht dealer or marine outlets.

Be sure to turn the fresh water pump at the main salon DC panel off before performing any type of maintenance.

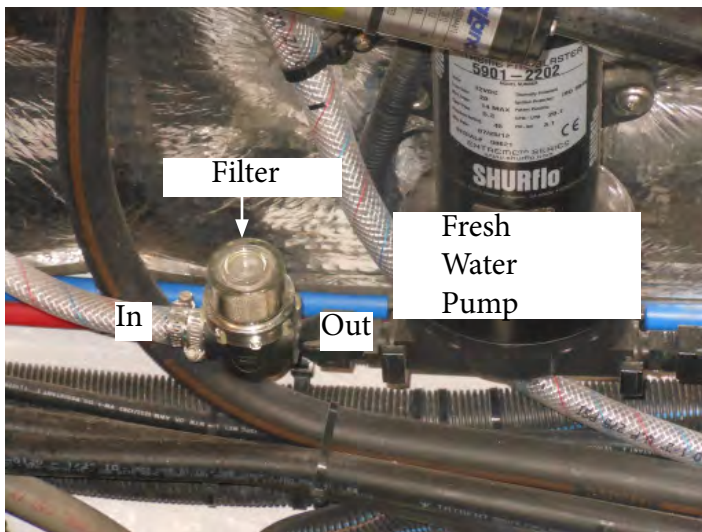

TYPICAL FRESH WATER PUMP



SATELLITE RADIO

Sirius satellite radio features over 120 channels of music entertainment completely commercial-free along with sports and news channels. Sirius emphasizes the music and entertainment you want. Channels use the most updated digital filtering available for the clearest sound. Sirius uses three satellites flying over the United States for coast to coast coverage with high elevation angles. The result is a clearer line of sight and less signal blocking. The system consists of the stereo receiver (sometimes called the head unit), radio tuner and antenna. With these components and an active account initialized by the customer on delivery your Sirius system should be ready to operate.

Following are the activation steps to be taken:

- A. Unit must be completely installed and the antenna must have a clear view of the sky.
- B. Turn on the radio and go to satellite mode.
- C. Confirm reception by tuning to SIRIUS WEATHER & EMERGENCY//CHANNEL 184. If you are not receiving Channel 184, please refer to the radio manufacturer owner's manual.
- D. Call SIRIUS sales support 1-888-465-8516 or customer care 1-888-539-7474.
- E. Please have your name, address, phone number and the SIRIUS ID#ESN available for the agent.



Auxiliary Equipment Operation

SHOWER-TRANSOM TYPICAL



The transom shower is located at the starboard transom area. The shower head features a flexible extended hose with a hot/cold water control knob. Like residential plumbing, the red dot denotes hot water and the blue dot cold water. When using this feature balance the hot and cold as required to achieve a desired and safe operating temperature. Turn the control knob to the “off” position when not using the unit.



SEARCH/SPOT LIGHT



The spotlight feature a 20,000 candle power light beam which can penetrate up to over 1/2 a mile in ideal conditions. The 2 speed searchlight provides up to 370° horizontal rotation and up to 135° vertical tilt with a dash

mounted fingertip control pad. The bulb provides superior light penetration. Included is a protective lens cover. Note that the searchlight is a radio transmitter and operates at 433 Mhz. When the light is activated, the internally mounted antenna sends out radio frequency (RF) energy. Note that it is possible that this component could affect other electronic equipment. Refer to operator's manual for possible solutions should this occur.

Operation-

1. Using the dash mounted remote control, turn the unit on by depressing the on/off button.
2. Using the same dash mounted remote control, rotate your light to the desired location.
3. The light speed can be controlled by depressing the fast/slow button one time and by depressing it again to restore the original speed.
4. The light should not be turned on when the snap on lens is attached. The hard wired dash control will be backlit when the bulb is illuminated.

The dedicated circuit is uses a 10 amp breaker on the power side for overcurrent protection.

The unit uses a Phillips 9011 bulb replaceable from Go-light, Inc. at 800-557-0098.

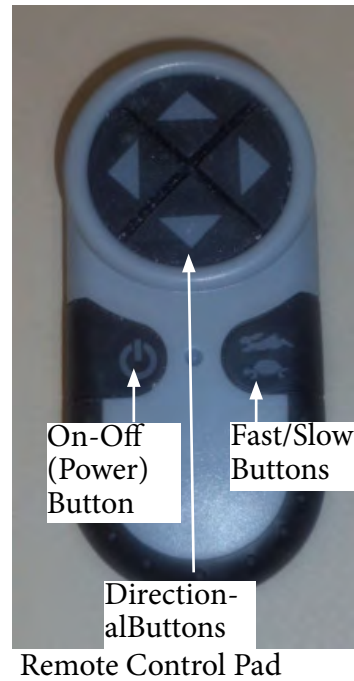



Auxiliary Equipment Operation

SIRIUS MARINE WEATHER-TYPICAL

This option provides peace of mind and safety by allowing the captain to access the latest weather information through satellite. The data can be viewed through the “E” series GPS/Plotter (option) at the helm or the salon television.

The service provides comprehensive weather data and state-of-the-art forecasting including buoy reports, WSI NOWRad® (nationwide high-resolution weather radar imagery) to anticipate coming trouble and high-resolution sea surface temperatures that can help fisherman. Subscribers can use the SIRIUS satellite footprint which blankets 48 contiguous states, most of Canada and Mexico; and waters extending hundreds of miles into the Atlantic and Pacific oceans, the Gulf of Mexico and Caribbean.

SIRIUS MARINE WEATHER ACTIVATION

1. Power up the receiver by activating the power button on the “E” series GPS/Plotter.
2. Dial 1-800-869-5480 to activate the service. The customer normally carries out this operation. Regal supplies a 6 month subscription for the customer.
3. Be prepared with your billing information, subscription preferences and the SIRIUS ID# for your receiver.
4. The SIRIUS ID# of your receiver will be viewable via the “E” series GPS/Plotter.

OVERVIEW

The following information is for United States weather only. A Navtex receiver must be used for worldwide weather.

The weather application superimposes historical, live and forecasted weather graphics and their associated weather data on the “E” series GPS/Plotter. All this information allows the skipper to determine the actual conditions in his vicinity or at another location. Weather forecasts and warnings, detailing current and preferred conditions are updated often using the WSI NOWRad® system.

For types of warnings, watches and advisories, please refer to the NOAA website at www.nws.noaa.gov.

OPERATION

To operate SIRIUS marine weather:

1. The Raymarine SR100 (earlier) or Garmin (later) receiver must be up and running. Also, it will not work in a covered boat house or dwelling.
2. The “E” series GPS/Plotter must be energized.
3. For your vessel to be displayed and for weather reports to be available at your position, you will need a fix for your boat’s position and be within US coastal waters.
3. You must customize a page to include a weather application. The weather application normally is not part of the pre-configured page sets. See the following page.
4. Specify the weather elements you want to display.
5. When you open the weather application, a map is displayed. If you have fixed a position for your vessel, the map will be centered on your boat.
6. Use the cursor to move around the map and view different locations. Use the range button to zoom in and out. For re-centering the map on your boat, use the FIND SHIP soft key.



Typical Weather Application Set-Up

To customize a page on the “E” series GPS/Plotter for weather do the following:

1. Press and hold the “PAGE” key until the “SELECT PAGE SET” box appears.
2. Using either the rotary knob or the directional pad, select the page set to which you wish to add weather.
3. Press the soft key labeled “EDIT PAGE SET”, then press the soft key that corresponds with the page you wish to edit.
4. At this point, you will be able to change the page layout using the directional pad and re-configure all windows in the page or you can leave the layout the same by pressing OK.
5. Press the “ACTIVE” key repeatedly until a red box appears around the application for the selected window (in this case, weather).
6. When your page is set up with the desired set of applications, press “OK”.

Note: Once you actually start to manipulate the pages, on screen instructions will guide you through the process.

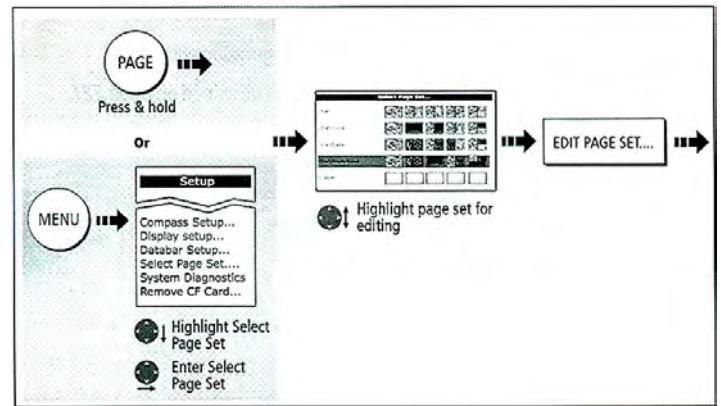

Re-configuring For Weather Application

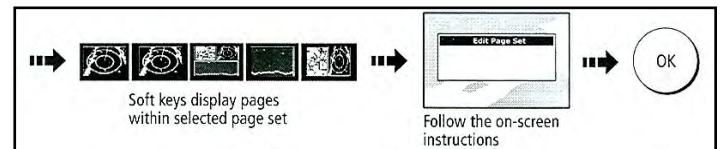

Editing A Page Set

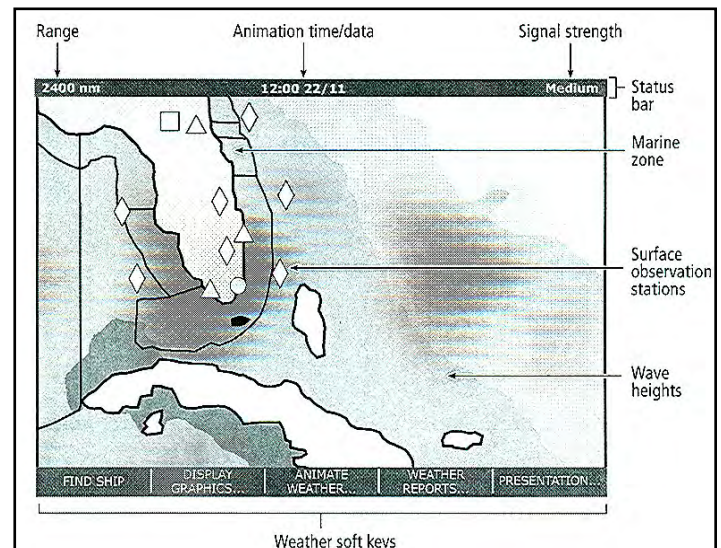

Sirius Marine Weather Map(Typical)



Auxiliary Equipment Operation

STABILIZER- SEAKEEPER

Introduction-

Resonant boat roll is the most disorienting contrast with dry land experience and the least desirable motion on a boat. Uncomfortable, tiring, and probably the greatest cause of seasickness, it has been an unavoidable price to pay for many for the pleasure of being on the waterways.

Seakeeper's® unique state-of-the-art motion control system actively regulates the hydraulic braking system to ensure the anti-roll torque is maximized for all hull designs and for the ever-changing operating and sea conditions.

Theory Of Operation-

Read the following pages for an introduction to operating the gyro. For more detailed information refer to the Seakeeper Operation Manual. Read and understand all safety warnings before attempting to operate the device. If installed, the Seakeeper® uses a gyroscope (gyro) to reduce boat roll motion. The gyro gimbal rotation angle around a predetermined axis (precession rate) is the basis of its operation. The amount of torque applied to the vessel hull to counter a wave induced roll is directly proportional to the gyro precession rate.

The further the gyro is from a vertical zero degree position the lower the anti-roll torque. The entire cycle is actively controlled by an electronic controller and a hydraulic brake system during each roll. At this point the gyro supplies the maximum rolling torque and avoids mechanical contact with hard stops. The mechanism is limited to a maximum gimbal swing of +/- 60 degrees. The gyro features a flywheel integrated inside a cast aluminum vacuum-tight enclosure. The flywheel spins around the vertical axis and is supported by bearings. A brushless motor found inside the enclosure turns the flywheel at high velocity.

The gyro enclosure is secured to two gimbal shafts that are supported by a pair of gimbal bearings on each side. These shafts produce an athwart ship gimbal axis for the gyro to precess to the specified angles.

The gyro enclosure is secured to two gimbal shafts that are supported by a pair of gimbal bearings on each side. These shafts produce an athwart ship gimbal axis for the gyro to precess to the specified angles.

Each gimbal bearing is supported by saddle beams which are bonded to the hull stringers. These beams transfer the loads that the gyro produces to the hull.

An active hydraulic brake mechanism regulates the rotation about the gimbal shaft.

The gyro features a closed cooling system with heat exchanger and reservoir, and temperature regulating valve.

System uses glycol anti-freeze routed through the motor drive box, hydraulic manifold, and the end caps of the enclosure to remove heat.

There is a helm mounted display panel used to start, operate, monitor and shutdown the gyro.

Display provides information in the event of an alarm.

Alarms cause the precession process to stop (Lock) and the gyro to start coasting down (Stop).

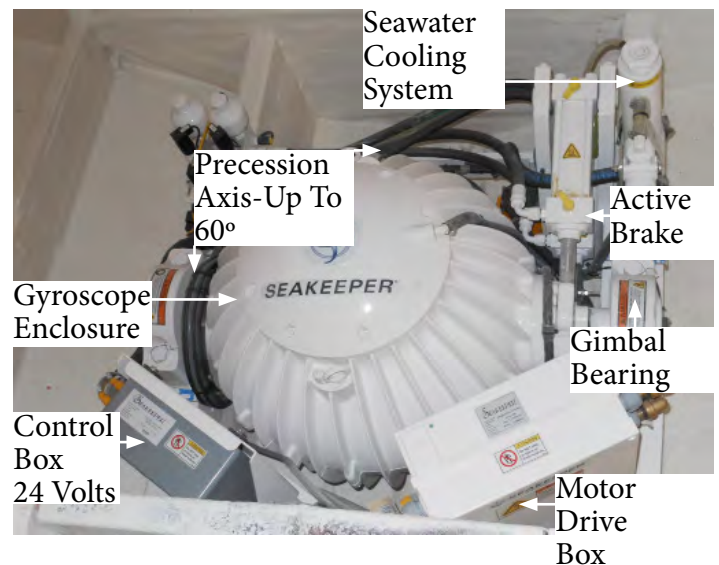



Initializing Seakeeper

To operate the Seakeeper start the upgraded generator and let it run for a few minutes. Remember that the generator is the source of power while at sea. Refer to chapter 4 for generator information. The stabilizer circuit breaker found on the 240 volt side of the ship's AC panel needs to be energized. Next, there is a circuit breaker on the 12 volt (DC) side of the ship's panel marked stabilizer that needs to be activated. Power will now be available to the helm mounted display panel. At this point the Seakeeper can be powered up.

Read the following pages for an introduction to initializing the gyro. For more detailed information refer to the Seakeeper Operation Manual. Read and understand all safety warnings before attempting to operate the device.



Auxiliary Equipment Operation

Display Screens: Overview

- 1) When voltage is initialized at the Gyro Control Box, a splash screen will be shown.



- 2) After the DISPLAY has initialized the HOME screen will be displayed



- 3) The DISPLAY has a set of five buttons that are under the BUTTON ICONS that appear on the display screen. The BUTTONS are the means for selecting the functions of the DISPLAY.





a. HOME Screen BUTTON ICON function

- i.  GYRO ON/OFF and FAULT RESET

1. The ICON will change from red (GYRO OFF) to green (GYRO ON)
2. The ICON will turn red indicating the GYRO is off when a fault appears
3. When a FAULT occurs the BUTTON is used to reset the active fault

- ii.  GYRO LOCK/UNLOCK

1. When the GYRO control is initializing, or the GYRO off, the lock symbols will both be blue

2. When the GYRO is in LOCK mode, stabilization is off, the LOCK

symbol will be red 

3. When the GYRO is UNLOCK, stabilization is on, the UNLOCK symbol

will be green 

- iii.  DISPLAY DAY/NIGHT

1. Toggles the DISPLAY brightness between the Day and Night settings



Auxiliary Equipment Operation

1. Switches the HOME screen views from an animation screen, to a screen displaying arrows with no animation, to a screen that shows GYRO rate on a graph



Home Screen with Animation:
Flywheel will be spinning and
gyro stabilizing



Home Screen with Arrows for
flywheel spinning and stabilizing

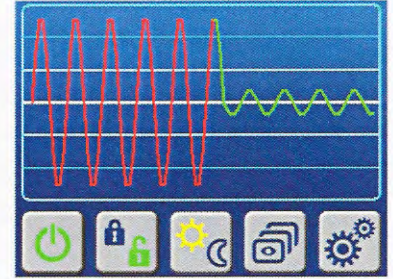

Home Screen indicating Gyro
Rate

v.  SETTINGS SCREEN

1. Changes from the HOME screen to the SETTINGS screen

- 4) When the button is depressed for the SETTINGS screen  the DISPLAY changes to the SETTINGS screen



a. SETTINGS screen BUTTON ICON functions



SEAKEEPER SPECIFICATIONS

Rated RPM	8,000 RPM
Angular Momentum at Rated RPM	8,000 N-M-S
Anti-Rolling Torque at Rated RPM	17,143 N-M
Spool-up Time to Rated RPM	35 Minutes
Spool-up Time to Stabilization (75% Rated RPM)	20 Minutes
Spool-up Power	
AC Motor	3000 Watts Max
DC Motor	240 Watts
Operating Power	
AC Motor (Sea state dependent)	1500-2500 Watts
DC Control	240 Watts
Voltage	
AC Input	208-230 VAC ($\pm 10\%$), 50/60 Hz, Single Phase
DC Input	24 VDC @ 10 Amps
Sea Water Supply to Heat Exchanger	30 LPM (8 GPM) maximum 15 LPM (4 GPM) minimum
Maximum Ambient Air Temperature	60 Deg C (140 Deg F)
Weight	549 Kg (1210 Lbs)



Auxiliary Equipment Operation



WARNING

AVOID SERIOUS INJURY OR DEATH FROM HIGH VOLTAGE COMPONENTS.

THE COMPACT MOTOR DRIVE BOX CONTAINS HIGH VOLTAGE ELECTRONICS AND THE COVER SHALL NOT BE REMOVED WHILE THE FLYWHEEL IS SPINNING EXCEPT BY AN AUTHORIZED TECHNICIAN. THIS HIGH VOLTAGE EXISTS EVEN IF THE FLYWHEEL IS COASTING DOWN AND THE SUPPLY VOLTAGE HAS BEEN SHUT OFF.



WARNING

AVOID SERIOUS INJURY OR DEATH DUE TO REVOLVING COMPONENTS.

IF IT IS NECESSARY TO STOP GYRO MOTION PRESS THE LOCK/UNLOCK BUTTON; THE LOCK SYMBOL WILL TURN RED INDICATING THAT THE GYRO IS LOCKED. NEVER ATTEMPT TO WORK ON THE GYRO UNTIL THE FLYWHEEL HAS STOPPED SPINNING. IN THE EVENT THAT THE GYRO SYSTEM HAS AUTOMATICALLY LOCKED THE GYRO DUE TO AN ALARM OR FAILURE, NO ATTEMPT SHALL BE MADE TO BYPASS THE ALARM OR THE AUTOMATIC LOCK.

NOTICE

THE CIRCUIT BREAKERS SHOULD BE LEFT ON AS LONG AS POSSIBLE WHILE THE GYRO IS SPINNING TO REMOVE HEAT FROM GYRO.

DURING NORMAL OPERATION, THE GYRO SHOULD BE STOPPED WHEN PULLING INTO PORT AND STABILIZATION IS NO LONGER REQUIRED. THIS MAXIMIZES LONG TERM LIFE AS IT ALLOWS THE GYRO TO START THE COAST DOWN CYCLE BEFORE COOLING IS SHUTOFF.

ONCE THE VESSEL IS SECURED IN THE SLIP AND THE CREW HAS SHUT DOWN THE GENERATOR AND ENGINES, THE AC AND DC BREAKERS THAT CONTROL THE GYRO SHOULD BE SWITCHED TO THE OFF POSITION. THE GYRO WILL CONTINUE TO SPOOL DOWN TO ZERO RPM. NOTE GYRO WILL TAKE 4.5 HOURS TO COAST DOWN TO ZERO RPM FROM FULL SPEED. THE DISPLAY WILL INDICATE 0 RPM WHEN THE FLYWHEEL HAS STOPPED.



SWIM (BOARDING) LADDER

When using the swim (boarding) ladder open the hatch and slide the ladder out to the end of the travel. Then flip the ladder over and let it down gently. Make sure you keep your hands and fingers clear of any moving ladder parts especially the hinged top.

Use the safety handrails to ease water entry and exit. When not using the swim ladder be sure to keep the ladder cover over the ladder to prevent trip and fall incidents.

Insist that only one person use the ladder at a time. Periodically check the ladder hardware for tightness and corrosion. Replace fasteners and lubricate hinges as needed.

Read and understand all warning and information labels found on the swim platform and ladder cover. Never exceed the maximum poundage recommended for the swim platform as noted on the label.

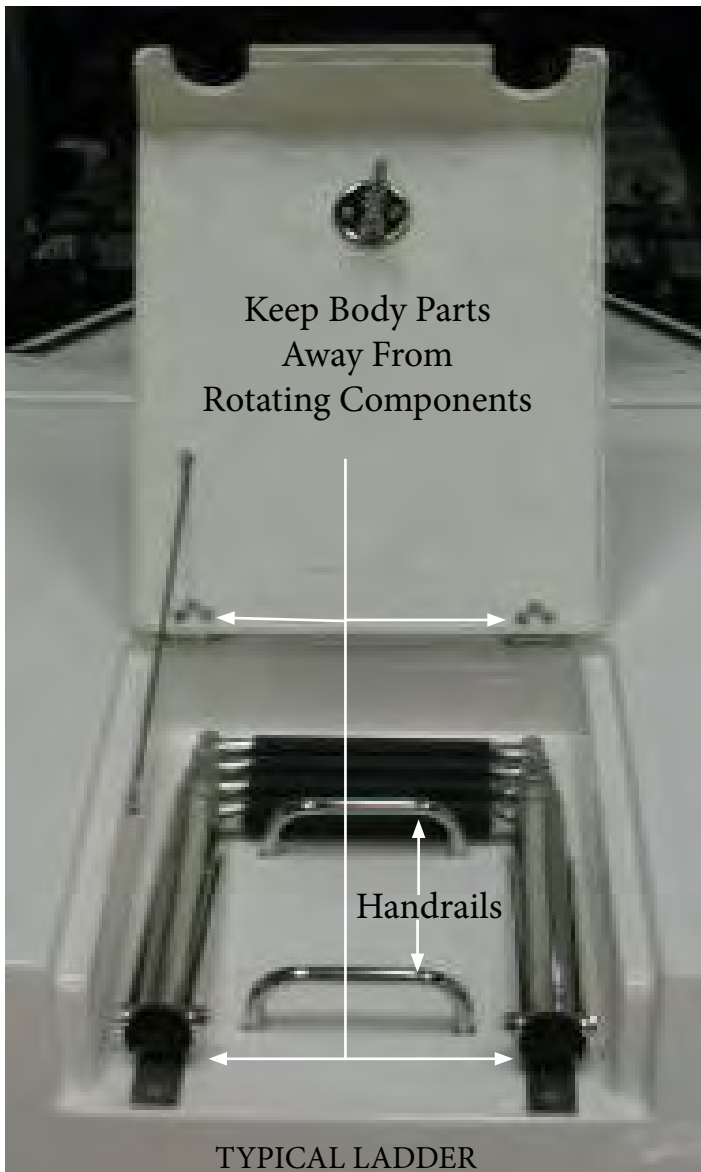
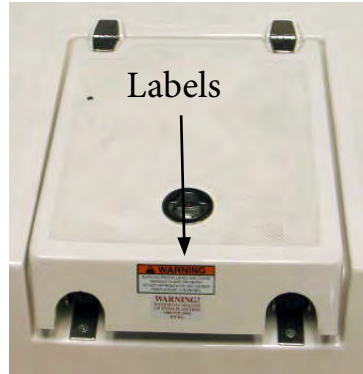

	WARNING
TO AVOID BODILY INJURY TURN THE ENGINES AND GENERATOR OFF AND REMOVE THE IGNITION KEYS WHILE PEOPLE ARE SWIMMING NEAR THE VESSEL AND/OR USING THE SWIM PLATFORM OR LADDER.	



Auxiliary Equipment Operation

SWIM PLATFORM

The swim platform is used with the boarding ladder to enter and exit the water. Never dive from the swim platform or swim under it. The swim platform is not intended to be used for storing heavy objects. Keep the platform surface free of objects to prevent bodily injury due to falling. Periodically inspect all swim platform fasteners and stanchions under the platform for tightness and corrosion. Replace parts as needed.

Do not exceed the swim platform recommended poundage capacity.

Use the swim platform cleats for temporary tying only such as stopping at an on-the-water restaurant or fuel dock. Use the other deck cleats for permanent moorings. When securing lines leave enough slack for local tidal changes.

Never use the swim platform cleats for towing!

Never attempt to lift the boat using the swim platform cleats or any other cleats on the vessel! See the section on sling markers. Never swim around or under the swim platform while the engines are running due to the effects of carbon monoxide poisoning. Read and understand all CO and rotating PROPELLER labels in the safety on board chapter.

WARNING

TO AVOID BODILY INJURY
TURN THE ENGINES AND GENERATOR OFF
AND SAFELY STORE THE KEY FOBS
WHILE PEOPLE ARE SWIMMING
NEAR THE VESSEL, USING THE SWIM
PLATFORM OR LADDER.

WARNING

AVOID SERIOUS INJURY OR DEATH!
NEVER OPERATE THE VESSEL
WITH PEOPLE ON TOP OR HOLDING ON TO
THE SWIM PLATFORM
STRUCTURE OR HARDWARE.



UNDERWATER LIGHTING

OVERVIEW

The underwater lights provide high output, long life and low heat emission. The lights form an electronic cluster known as an LED. The housings are made from a high impact resistant polycarbonate material. The lights are installed at the transom for maximum efficiency. Their beam is blue for increased underwater penetration.

OPERATION

The underwater lights are energized through the switch located at the aft cockpit switch panel. The lights are protected by a 5 amp in-line fuse.



Typical Underwater Light Shown



Cosmetic Care & Maintenance

COSMETIC CARE



This chapter covers the general care of your Regal yacht. Be sure to read and understand all vendor supplied information on cosmetic care. Many cosmetic care topics are described and expanded in the following pages.

For selected items there may not be specific vendor information available in the owner's information packet. Therefore, we have provided customer cleaning information as needed on each of these topics.

Where cleaning methods are suggested try them on a small area before applying to the entire surface. Never use toxic or caustic chemicals on your yacht. Read and understand each cleaning agent before using it. The labels will alert you to limitations and safety information for each cleaner.

Never mix cleaning agents since this may produce an unsafe chemical reaction which could be toxic, produce fire or explosion and/or effects that may be harmful to the human body.

Provide fresh air while using cleaning agents to reduce any effects of chemical inhalation by opening hatches, portlights and the main companionway door. It is recommended to vacate the area until any chemical odors are diminished.

Most of all, use common sense!



BILGE/ENGINE COMPARTMENT

Always keep the bilge pumped out and free of accumulated debris. If oil accumulates on the engine compartment floor becomes it is usually related to engine oil lines, a loose component such as an oil filter, oil pan drain bolt or a leaky gasket/O-ring. Always find the cause of smaller problems before they become larger more expensive ones. The engine compartment, bilge or sometimes called the sump features a light colored gel finish that will be beneficial in finding leak sources.

A periodic bilge cleaning with a brush and bilge cleaner (purchase at a marina or supplier) will be helpful in maintaining an orderly and safe bilge since accumulated dirt and fluids could cause someone to fall. Do not pump bilge contaminated oil overboard but deploy it to a waste receptacle for recycling. Check the fuel system including all hoses, tanks and connectors for possible leaks and deterioration. A stained area normally could suggest a hose or connection leak.

Inspect all wiring including connectors and hangers for tightness. Clean fuel filters as suggested by the engine manufacturer.

Check all engine and water/waste hoses for tightness and deterioration. Tighten all hose clamps as needed.

Check all battery hardware and terminal connections. Fill the battery cells with distilled water (wet-cell type only) to the battery manufacturer's suggested level.

Check the transom area for loose hardware. With IPS systems refer to the vendor owner's manual for any engine room maintenance on the stern drive system.

Do not use any flammable products in the bilge. Use environmentally approved procedures to dispose of oily or soiled cloths.

BOTTOM PAINT

Bottom paint in fresh water normally accumulates a bit of algae and slime over a period of time even more so if the vessel is not used. Most of this can be wiped off with a turkish towel or the back side of a piece of rug while the boat is in the water. Stay away from using a stiff bristle brush, wire brushes or abrasive materials which may harm the bottom paint barrier.

If used in saltwater the bottom may have accumulated some barnacle growth. Sometimes a diver can be hired in lieu of hoisting the vessel to clean the growth.

Periodically, the best way to inspect the bottom is to have the boat lifted out. Make sure the straps are evenly lined up with the sling markers on the deck. Look for scrapes in the gelcoat along with any loose or damaged underwater hardware.

Also, this is an excellent time to check for damaged propellers and underwater hardware. The hull bottom and paint should be inspected annually and touched up as needed by your Regal yacht dealer.

Make sure to leave the required spacing (at least 1") when touching up to protect hull components ie; trim tabs, drive parts, anodes from electrolysis potential. Never paint any of the above mentioned parts with bottom paint.

NOTICE

WIRE BRUSHES, SCOURING PADS,
OR OTHER ABRASIVE TYPE MATERIALS
AND SOLUTIONS SHOULD NEVER
BE USED ON THE HULL OR DECK
OF YOUR BOAT.
THEY CREATE SMALL SCRATCH
MARKS THAT WILL COLLECT MARINE
GROWTH AND OTHER FOREIGN
MATERIALS.



Cosmetic Care & Maintenance

CABINETS



The handcrafted interior cabinets feature a sprayed clear coat finish. This clear coat produces a hard finish which is baked on and is very resilient. Use a warm solution of water and mild detergent to keep the cabinet surfaces looking new. Wipe the surface with the solution using a soft damp cloth, and dry with a soft clean towel. This procedure should eliminate most stains and oily finger marks.

Stay away from heavy scrubbers and compounds which may harm the surface. Avoid polishes containing silicones.

Use the specifications below as a guide for any cabinet repairs or interior refurbishing needs.

APPLICATION	ADHESIVE
WOOD TO WOOD	WOOD GLUE
WOOD TO FORMICA	CLEAR SILICONE
FORMICA TO FORMICA	CLEAR SILICONE
SINK INSTALL	CLEAR SILICONE
CORIAN TRIM	SIKA FLEX 291
MIRROR TO FORMICA	MIRROR MASTIC
GRANITE TO WOOD	SIKA FLEX 291



CANVAS CLEANING INSTRUCTIONS

Canvas should be cleaned regularly before substances such as dirt, roof particles, etc., are allowed to accumulate on and become embedded in the fabric. The fabric can be cleaned without being removed from the boat. Simply brush off any loose dirt, hose down, and clean with a mild solution of natural soap in lukewarm water. Rinse thoroughly to remove soap. **DO NOT USE DETERGENTS!** Allow to air dry.

For heavily soiled fabric, remove the top from the frame. Soak the fabric in a solution that has been mixed to the following proportions: 1/2 cup of bleach and 1/4 cup of Ivory or Lux soap (liquid or soap) per each gallon of lukewarm water. Allow the fabric to soak until the bleach has killed the mildew and the stains can be brushed out with a common kitchen scrub brush. Rinse the fabric thoroughly in cold water to remove all the soap. This may require several rinsings. Incomplete rinsing can cause deterioration of sewing threads and prohibit the fabric from being properly retreated. Allow the fabric to dry completely.

DO NOT STEAM PRESS OR DRY IN AN ELECTRIC OR GAS DRYER!

Excessive heat can damage and shrink the fabric since it is heat sensitive.

This method of cleaning may remove part of the water and stain repellents that was applied to the fabric during its manufacture. It is recommended to retreat with such water repellency products as Apseal and Uniseal. We do not recommend any wax based treatments such as Thompson's Water Seal or any of the silicone products such as SC-15 or Aqua-Tite. Wax based products prevent the fabric from breathing, and encourage mildew growth while the silicone products interact with the original fluorocarbon finish and seem to cause a rapid loss of water repellency. Scotchguard has not been found to be very effective for restoring water repellents to Sunbrella. It seems to work well in the short run, but not long term.

CLEAR VINYL, ZIPPER & SNAP CARE

Never store canvas wet or in an unventilated, moist area. Always roll the canvas instead of folding. This is of particular importance on side curtains or any other part with the clear vinyl "glass". Roll the top carefully around the bows and cover with the storage boot provided.

The clear vinyl "glass" used in side curtains, aft curtains, visors, and camper enclosures is very susceptible to heat and cold. Keep vinyl curtains from touching metal tubing to minimize burning the vinyl.

If the boat is stored with top, side curtains and aft curtain in place, heat build up inside the boat may discolor the vinyl.

To clean the clear "vinyl" glass, use a solution of Ivory or Lux soap, liquid or flakes, and lukewarm water. Allow to air dry. Never use any type of abrasive cleaner as it will scratch the "vinyl" glass. There are many cleaners and scratch removers on the market specifically for clear vinyl. Handle the clear curtains carefully. They are soft and prone to scratching.

Canvas parts are designed with zippers. When zippers are new they can be a little difficult to use. Zip carefully without forcing the zipper or the material. They will loosen with use. A zipper lubricant may be used to help new zippers as well as maintaining used ones. The most vulnerable part of the zipper is the starts. Use care when starting the zipper.

Canvas snap fasteners should be unsnapped as close to the button as possible. Never remove canvas by pulling roughly on the edge of the material. This can damage the canvas as well as the fasteners. Use petroleum jelly on snaps to keep them from developing corrosion especially in harsh environments.



Cosmetic Care & Maintenance

CARPET-INTERIOR

The interior cabin carpet is produced from 100% BCF nylon. The nylon is treated tropically with an anti-soil chemical that will assist in keeping your carpet looking beautiful longer.

General Care and Maintenance

Your carpet is a high luster nylon that can look great for years to come provided you follow some basic care and maintenance. Nylon is the highest performing synthetic fiber in the market and has dense pile that will give a long wear cycle and high performance.

The following will help maintain your carpet:

Regular Vacuuming

This is the most important single factor in keeping carpet beautiful is to vacuum it on a regular basis. Sand and dirt particles will abrade the carpet fibers in a faster manner. This abrasion will cause non-repairable damage to the fiber that will reduce the carpet's life expectancy. Use a vacuum with a beater bar verses a vacuum alone as it will lift the fiber and help open the carpet to allow the vacuum to remove grit.

Professional Cleaning

Interior carpet is the same as high-end residential carpet and the carpet should be treated accordingly. Periodic professional carpet cleaning using either the hot water extraction or dry cleaning powder method will help maintain the beauty of your carpet. This will remove the ground in soil.

Spills

At some point in the life of the carpet, there is always the potential for a spill. Remove the spill immediately. The quicker the spill is removed, the easier it is to clean up. The longer a spill stays on the carpet, the more likely it is to stain the fibers, regardless of the cleaning treatment used. When a spill occurs, always blot the area being cleaned. Do not rub or scrub. Follow the cleaning instructions.

Cabin Door/Cockpit Entrance Mats

Entrance mats on a boat are very important to help reduce the dirt and sand that is brought on to the carpet. Also, entrance mats reduce the amount of moisture being tracked on to the carpet, which will cause matting of the fibers.

Mats can be ordered from your Regal dealer. These mats fit the nautical decor and provide the best surface to catch dirt and sand particles. Also, entrance mats can be obtained from local sources. Look for mats with a non-skid backing

Use approved carpet cleaners only. Always try on a test area first. Many spots and spills can be removed using a cleaner combined with a clean, white terry towel. Try not to soak an area excessively and do not use solvents because most interior carpet is glued in place. Solvents will break down the backing and fibers.

All stains should be removed as soon as possible as this enhances the ability to remove the stain.



COCKPIT COVERING- SEA GRASS



To store sea grass floor covering, roll it tightly. This will keep the product from developing wrinkles which result if folded.

If installed this product features a urethane backing which lends itself to an exceptional solution where style, comfort, and durability must be met as found in our marine environment. The oat colored material contains Microban®. This antimicrobial protection inhibits the growth of stain and odor causing bacteria, mildew, and mold for the life of the matting.

Please follow the care instructions listed below to keep your cockpit floor covering clean and looking like its original appearance.

To clean, simply wipe with soap, water, and a soft sponge or cloth. Standard antibacterial cleanser can also be used. Rinse with clean water and air dry.

Scrub stubborn stains with a soft brush and a bleach based cleanser. This will remove the stain without altering the fabric. Rinse with clean water and air dry.

Do not machine wash or use dishwasher on sea grass.

More permanent stains may result when certain foods or liquids (e.g. tomato, hot pepper sauce, turmeric) are left on the fabric for long periods before cleaning.

Make sure to remove such spills quickly.



Cosmetic Care & Maintenance

COUNTERTOP SURFACES- AVONITE®

Regal has chosen Avonite solid surface counter top material (high gloss finish) because of its elegance and durability. Periodic maintenance will ensure its beauty. Avonite® withstands heat much better than ordinary countertop materials but you must still use a hot pad or trivet when taking materials directly out of the oven or stove top to protect from damaging the surface. Avoid cutting directly on the surface.

Another feature of Avonite surfaces is that they are non-porous. Therefore, dirt and germs do not penetrate it. Avonite surfaces will not support the growth of germs and mildew. To disinfect or clean see the table.

You can use 3M Perfect-it and a soft cloth to remove stubborn stains. The surface must then be machine polished back to its original high gloss finish. If you do not own or have access to this equipment contact your local Avonite Surfaces fabricator for assistance.

Darker colors tend to require more frequent cleaning to maintain a uniform finish. Also, darker colors tend to show fine scratches more easily and require more attention than lighter colors.

DO'S & DON'TS

1. Always use a hot pad or trivet under hot pans or heat producing appliances.
2. Always use a cutting board.
3. Never stand on your countertops.
4. Avoid hard chemicals such as drain cleaners and paint removers.
5. On Regal vessels with high gloss countertops place felt protectors on the bottom of pottery or other hard objects. Avoid sliding hard objects across these glossy surfaces.



PROBLEM	SOLUTION
Dirt and Residue	Use soapy water, ammonia based cleaner (not window cleaner), rinse and <u>wipe completely dry</u> . Commercially available solid surface cleaners such as Clean Encounters® will work well too.
Preventing Hard Water Marks	Rinse & <u>wipe completely dry</u> after cleaning; clean up spills before they dry.
Removing Hard Water Marks	Use a cleaner formulated for removing hard water marks such as CLR or Lime-A-Way
Disinfecting	Occasionally, wipe surface with diluted household bleach (1 part water/1 part bleach). Rinse top thoroughly with water and <u>wipe completely dry</u> .



ELECTRIC GRILL



STAINLESS STEEL SURFACES

The best way to clean metal surfaces on your grill is to wipe them down with a damp cloth and then thoroughly dry. Stubborn spots caused by spillage and discoloration from heat may be removed by lemon juice, vinegar, or chrome polish. Keep these cleaning products away from porcelain enamel surfaces. Never use coarse cleaners, steel wool scouring pads or metal brushes to clean stainless steel. These methods will allow deep scratches to develop on the stainless steel that cannot be removed.

PORCELAIN ENAMEL

Porcelain enamel is glass fused on steel at very high temperatures. It is not overly delicate but must be treated like glass. Sharp blows, radical changes in temperatures, etc; will cause the enamel to crack or chip. Some foods contain acids which will dull the finish of the enamel.

FABRICS-INTERIOR

Clean flat good interior fabrics with dry cleaning fluid style cleaners approved for use with soft fabrics. Allow adequate ventilation and follow the label instructions carefully. Use protective eye wear and gloves. Do not inhale the chemicals.

Use a soft cleanser with feldspar to clean stubborn marks or stains on wallpaper.

Normal interior vinyl such as the headliner need a mild soap and water solution. Rinse immediately with clean water and wipe dry. Always test a small area with a cleaner before applying it to a larger area.



Cosmetic Care & Maintenance

FIBERGLASS & GELCOAT



Routine maintenance is the only practical way to keep the surface of your boat looking shiny and new. Most objects left outdoors will gradually deteriorate from exposure to the sun, water, dust and pollution. Such outdoor exposure can cause your boat's gelcoated surface to change or fade. Darker colors tend to fade more rapidly than

lighter colors because they absorb more of the sun's rays (ultraviolet and infrared).

Basic maintenance includes monthly washing of the boat's surface to remove normal accumulation of soil and stain. Use a mild detergent such as dishwasher powder or liquid. Do not use automatic dishwasher detergent. Avoid any kind of alkaline cleaners such as tri-sodium phosphate (TSP), abrasives, bleaches and ammonia. For best results use cleaners that are recommended for fiberglass. It is recommended that you wax the gelcoat surface twice yearly to prevent loss of gloss and to protect the finish. Use only waxes for fiberglass and follow the label instructions. Apply a 3' x 3' section at a time using clean applicator cloths or a buffing bonnet. When a haze develops, use a power buffer at low speeds (1200-2000 rpm) to remove the haze. Keep the buffer moving to avoid heat build-up. Never wax gelcoat in direct sun.

When the washing and waxing as recommended does not restore the shine it may be necessary to use a fine rubbing compound. Do not apply rubbing compound in direct sunlight. A power buffer at lower speeds does an excellent job to remove impurities from the gel coat that cause dulling. Use light pressure and keep the buffer moving. Re-wax after compounding to buff the surface. "Hairline cracks" or "spider webbing" could develop in the gelcoat surface of a hull or deck. This can be caused by impact or other factors. Small air pockets or gouges may also occur through normal wear. These do not affect the strength of the hull or deck and can be repaired by yourself, a marine professional or a Regal dealer.

The affected area should be chipped or sanded away and a thin layer of color matched gelcoat applied. This layer is then sanded smooth and buffed to its original luster. Most minor scratches, nicks, and dents can be removed by compounding the surface. Marine type compounds can be found at most auto body supply stores.

Specify a number 25 which is a coarser compound up to a number 55 being less coarse. Various glazes and polishes are available as needed. Ask your marine professional or Regal dealer for more information. Fiberglass hulls are strong but they can be damaged. A fiberglass hull has virtually no internal stresses. Thus when a part is broken or punctured, the rest of the hull retains its original shape. A severe blow will either be absorbed or result in a definite localized break. A break of this nature should be checked and repaired by a marine professional or a Regal dealer.

MINOR REPAIRS

You will need the following materials for minor repairs:

- Gelcoat
- Clear Liquid Catalyst
- Putty Knife
- Razor Blade
- Fine Sandpaper (400,600,1000)
- Wax Paper (to cover repair area)



WARNING

AVOID BODILY INJURY!
GELCOAT & FIBERGLASS RESIN
ARE FLAMMABLE.
WORK IN A WELL VENTILATED AREA
FREE FROM OPEN FLAMES.
DO NOT SMOKE!

For minor repairs refer to the following procedure:

1. Clean the area to be repaired and get rid of any wax or grease residues.
2. Clean out scratches, chips, and nicks.
3. Sand area to be repaired so gelcoat will bond.



CAUTION

AVOID BODILY INJURY!
WAXED GELCOAT SURFACES CAN BE VERY
SLIPPERY. DO NOT WAX NORMALLY USED
AREAS OF THE DECK, LINER, OR GUN-
WHALES. DO NOT WAX ANY TEXTURED OR
NON-SKID SURFACES SUCH AS FLOORS,
WALKWAYS, STEPS, LADDERS
OR SWIM PLATFORMS.
ALWAYS WEAR NON-SLIP FOOTWEAR
WHILE ON BOARD THE VESSEL.

4. In a separate container, measure only the amount of gelcoat you will need. Mix a ratio of 2% ratio of catalyst to the amount of gelcoat being used (a spoonful of gelcoat will require only a drop or two of catalyst). Do not pour any unused portions of the gelcoat/catalyst mixture back into either original container.

5. Apply gelcoat to area leaving a slight lift above the surface.

6. Cover the area with wax paper. It will help the mixture to set up faster.

7. Remove wax paper and shave off any extra gelcoat with a razor blade.

8. After the area is shaved smooth, start with the 400, 600, and finally 1000 grit sand papers.

9. Buff the area with compound, polish and a finish wax. You may notice a difference between the repaired area and the original finish due to the natural weathering process.



Cosmetic Care & Maintenance

FLOORS-HARD WOOD

Your Regal yacht may have engineered hardwood floors highlighting the interior. Your flooring was chosen because of its beauty, durability and care-free maintenance. Types used include birch and classic walnut among others.

Here are some do's and don'ts to follow in keeping your yacht flooring like new:

First, do remember that if you have been cleaning residential floors with vinegar and water, oil soap, furniture polish or window cleaner, you may be ruining your costly investment. These cleaners are a big no with hardwood floors.

Excessive wet mopping with water and vinegar can cause wood to expand, possibly permanently damaging the floor in addition to dulling the finish. Other cleaners that have silicone, wax or oil soaps can leave a residue on the finish and may cause the floor to be slippery which is what you do not need with a boat.

One residue-free, proven hardwood floor cleaner formulated specifically for polyurethane-finished hardwood floors is BonaKemi's Swedish Formula® Hardwood Floor Cleaner. This environmentally friendly, non-toxic, ph-neutral cleaner effectively cleans dirt, grease and sticky spills without leaving any dulling residue. Apply per container directions.

Preventative care of your floors is also extremely important for keeping hardwood floors looking like new. Vacuuming or sweeping floors regularly, promptly removing spills, and placing mats at cabin door and cabin stairway landing can be effective in trapping damaging sand and dirt particles before they can damage the floor. Avoid walking on floors with high heel shoes. Walking or tennis shoes with soft soles are better and safer to help prevent falls while on the vessel. The harder heels especially black ones tend to leave scuff marks on the floor surface. It is a good idea to keep the nails of pets trimmed, too.

Note: Use a soft application pad inserted in a long handle to apply product. Rinse often in a clean bucket with warm water which are available at most "box" stores.



Typical Engineered Hardwood Floor



GAUGES/SWITCH PANELS

If any gauges are installed for normal dirt and dust accumulation clean with soft cloth and warm water. Dry with a soft cloth or chamois.

Near salt water environments deposits can build up on the instrument bezels and faces. Use a soft damp cloth to remove the deposits. Do not use abrasives or rough, dirty cloths to wipe instruments.

Follow the same procedure for all switch panels. Use approved touch screen products such as you would use on computer monitors and lap tops.

Do not use any of the following on panels:

1. Lacquer Thinner
2. Dry Cleaning Fluid
3. Acetone
4. Carbon Tetrachloride
5. Benzine
6. Silicone Spray
7. Gasoline
8. Diesel fuel



Sometimes gauges develop condensation inside their faces. in high humidity environments. To eliminate the condensation droplets, energize the instrument lighting and the heat over a short period of time This process will evaporate the gauge condensation.



Cosmetic Care & Maintenance

HULL/DECK

HULL BOTTOM

Never use wire brushes or highly abrasive scouring pads on your hull bottom. It could damage the gelcoat surface or the bottom paint. The bottom of your boat needs to be clean since the build up of natural coatings from water or marine life can potentially create drag and affect boat performance. Use a turkish towel or for heavier build-up a piece of rug to clean the bottom.

HULL/DECK

For normal dirt and insect residue find a soft bristle brush on a long telescopic handle at an automotive store. A good brush is designed with a curved soft base to protect objects it comes in contact with while scrubbing. Rinse down the hull with a hose to loosen up the dirt. Use a mild soap solution in a bucket. Use up and down strokes to clean the hull sides. Rinse off until all residue is removed.

MICROWAVE OVEN

1. Turn off the oven.
2. Keep the inside of the microwave clean. When food splatters or spilled liquids adhere to oven walls, wipe with a damp cloth. A mild detergent may be used on extremely dirty surfaces. Avoid the use of sprays and other harsh cleaners as they may stain, streak, or dull the door surface.
3. The outside surfaces should be wiped with a damp cloth. To prevent damage to the operating parts inside the oven, water must not enter the ventilation openings.
4. Wipe the door and window on both sides, along with the door seals and related parts frequently with a damp cloth to remove any spills and splatters. Do not use any abrasive cleaner.
5. Do not allow the control panel to become wet. Clean with a damp cloth. When cleaning the control panel leave oven door open to prevent the oven from accidentally turning on.
6. If steam accumulates inside or outside of the oven door, wipe with a soft cloth. This may occur when the microwave is used in high humidity conditions and this is normal.
7. It is occasionally necessary to remove the glass tray for cleaning. Wash the tray in warm sudsy water or in a dishwasher.
8. Remove odors from your oven by combining a cup of water with the juice and skin of one lemon in a deep microwaveable bowl, microwave for 5 minutes. Wipe thoroughly and dry with a soft cloth.



CAUTION

AVOID BODILY INJURY!
GELCOAT SURFACES CAN BE VERY
SLIPPERY.
ALWAYS WEAR NON-SLIP FOOTWEAR
WHILE ON BOARD THE VESSEL.
ALWAYS RINSE SURFACES ADEQUATELY
TO AVOID SLIPPING
ON SOAPY SURFACES!



PLASTICS

There are different types of plastic aboard your vessel. Use plastic cleaners and polishes recommended for marine use only. Use proper applicators. Read all instructions carefully. Test the product in a small area first. Use a soft rag and always rinse the surface with water. Ammonia based cleaners will damage plastic parts.

One of the basic rules to cleaning plastic is never use abrasive cleaning products. Even hard plastic surfaces are easily scratched. Stay away from steel wool pads, powdered cleaners with abrasive qualities, or harsh detergents.

Instead use sponges, soft cloths, and mild detergents when cleaning plastic.

While cleaners in aerosol cans are convenient they may not be the best for certain types of plastic. Glass cleaner in a can or a spray bottle is not safe to use on your marine toilet fixture or toilet seat. Many times pits will develop over time and the toilet/seat will appear mottled and will not appear clean no matter how hard you scrub.

Refer to a marine store which possesses the expertise and experience to assist the boat owner in selecting the right cleaner for his marine plastic onboard needs.

NOTICE

NEVER CLEAN PLASTIC SURFACES WITH
A DRY CLOTH OR GLASS CLEANING
SOLUTIONS CONTAINING AMMONIA.
NEVER USE SOLVENTS
OR WIPE WITH ABRASIVES.

RANGE/STOVE

Clean the cook top before you use it for the first time. A thorough cleaning with a recommended product such as Cerama-Brite Cook Top Cleaner will put a clean shiny coating on the cook top before its initial use.

Always remove food spills, grease splatters, and metal rub-off from utensils. First, use a razor blade scraper to remove all spillovers. Then clean the cook top with a paper towel or a clean soft cloth and a recommended cleaner. After using any cleaner always wipe the cook top with a clean, damp cloth (to avoid burned-on cleanser residue) and wipe dry.

Do not use your dish towel or sponge to wipe off the cook top. This may leave a film of detergent or other matter that can cause discoloration the next time the cook top is heated.

Avoid abrasive scouring powders of any kind. Also, avoid using plastic, nylon or metal cleaning pads. They may scratch or melt onto the cook top. Avoid chemical cleaners such as chlorine bleach, ammonia, hydrofluoric acid or chemical oven cleaners. They may etch or discolor the surface.

Do not let anything that melts such as plastics, aluminum foil, or sugar to come in contact with your cook top surface when it is hot. Should something melt onto the surface, immediately move it to a cool area of your cook top with a razor blade scraper, and then remove it from the cook top as soon as possible.



Cosmetic Care & Maintenance

SPOTLIGHT

The spotlight lens should be wiped with a clean, dry soft cloth to remove any debris such as bugs, salt spray or general dirt. Read the manufacturer's literature for more information.

STAINLESS STEEL



Stainless steel is an alloy made from nickel, chromium and iron. It has been very successful in marine environments due to its ability to resist rusting. If the stainless steel product such as a bow rail is exposed to elements such as ocean spray it will begin to rust over time.

If your stainless steel shows signs of rusting:

1. Wash with fresh water.
2. Clean with a good quality chrome polish periodically but no less than twice annually. "Brasso" is another product that works well.
3. Also, using a good quality car wax will provide extra stainless steel protection.
4. For polished finishes that show grit lines an abrasive such as "Scotch Brite" or sand paper can be used. Always test a spot first and "go with the grain".
5. Do not use harsh solvents or cleaners on stainless steel.
6. Do not use steel wool or wire brushes. They will damage the finish.
7. Do not use any type of acids.



STAINS-TYPICAL

Below is a listing of normal stains and clean-up methods. The sooner the stain is removed there is less chance of permanent residue on the surface.

Do not use wire brushes, solvents or harsh chemicals on any stain. Damage to the surface will occur.

FREQUENT STAINS	CLEAN-UP STEPS		
	1	2	3
Coffee, Tea, Chocolate.....	B		
Permanent Marker*.....	E	B	C
Household Dirt.....	A	B	
Grease.....	D	B	
Ketchup, Tomato Products.....	A	B	
Latex Paint.....	A	B	
Oil Base Paint.....	D	B	
Mustard.....	A	B	C
Suntan Oil.....	A	B	
Asphalt/Road Tar.....	D	B	
Crayon.....	D	B	
Engine Oil.....	B		
Spray Paint.....	B		
Chewing Gum.....	D	A	
Shoe Polish*.....	D	B	
Ballpoint Pen*.....	E	B	A
Lipstick.....	A	B	
Eye Shadow.....	E	B	
Mildew*.....	C	B	A
Wet Leaves *.....	C	B	A

A= Soft brush; warm soapy water/rinse/ dry

B= Fantastik cleaner

C= One tablespoon ammonia, 1/4 cup of hydrogen peroxide, 3/4 cup of warm water/ rinse/dry

D= Scrape off residue (use ice to lift gum)

E= Denatured alcohol/rinse/dry

* These products contain dyes which leave permanent stains.



Cosmetic Care & Maintenance

UPHOLSTERY

Cockpit vinyl requires periodic cleaning to maintain a neat appearance and to prevent the build up of dirt and contaminants that may stain and reduce the vinyl life if they are not removed. The frequency of cleaning depends on the amount of use and conditions to which the vinyl is subjected.

Most common stains can be cleaned using warm, soapy water and clear rinses. Scrubbing with a soft bristle brush will help loosen soiled material from embossed surfaces and under welting. If the stains are not removed with the above method use a mild cleaner such as Fantastic. This cleaner should be used only as needed and not the normal means.

With more stubborn stains, rubbing alcohol or mineral spirits may be tried cautiously. Widespread solvent use can severely damage or discolor vinyl.

Try to remove stains immediately before they have a chance to penetrate the surface of the vinyl.

Powdered abrasives, steel wool, or industrial strength cleaners are not recommended for cleaning our vinyl. Lacquer solvents will cause immediate damage. Dilute chlorine bleach before using. Do not wax the vinyl as it may cause cracking. Always wear protective gloves and make sure there is sufficient ventilation when cleaning vinyl. Wear eye protection.

Remember that suntan oil will damage vinyl. Use suntan lotion instead of suntan oil. Exposure to the sun is a natural enemy of vinyl upholstery. For maximum life, use a cockpit cover when the vessel is moored, docked or stored.

Ultra Leather- interior vinyl that may of been featured in the salon sofa, salon seating arrangements, and both aft and forward berths. It can be identified for its softer leather touch over a firmer cockpit vinyl.

Contact your closest yacht dealer for more detailed information regarding the upholstery used on your hull number.

Clean Ultra Leather by following the information below.

1. Remove the stain immediately.
2. Spot clean with mild soap and water.
3. Air dry or dry quickly with warm setting of a hair dryer.
4. For stubborn stains, use mild solvent.
5. For tougher stains Fantastik® and Formula 409® brand spray cleaner have been shown to be successful.
6. Disinfect with a 5:1 bleach solution.

For the following stains, a mild detergent may be used. Blot or wipe stains immediately.

- A. Ketchup, Mayonnaise
- B. Butter
- C. Red Wine, Liquor
- D. Coffee, Tea, Coca-Cola®
- E. Make-Up, Face Cream, Lipstick
- F. Machine Oil
- G. Urine, Blood
- H. Steak Sauce, Soy Sauce
- I. Chocolate
- J. Milk



Ballpoint Pen Removal Instructions

1. Wipe the stain off with ethanol (rubbing alcohol).
2. Prepare a solution of 50% non-chlorinated bleach, 50% water.
3. Place a thin line of tissue over the ink stain.
4. Apply the non-chlorinated bleach solution to the tissue. Be sure not to saturate the tissue.
5. Cover tissue with polyethylene film (plastic wrap) to prevent the non-chlorinated bleach solution from drying.
6. Check on stain repeatedly.
7. Do not leave the non-chlorinated beach solution on for more than 1 hour.
When the stain looks almost gone, remove the tissue and wash the stain with water.
9. To neutralize the bleached area, place tissues on the bleached area and apply 15% hydrogen peroxide solution.
10. Leave on for 30 minutes, & then remove the tissues.
11. Remove the peroxide residue with water.

WINDSHIELD WINDOW FILM

Your yacht windshield may feature a protective coating that helps guard against infrared and ultraviolet radiation from the sun which results in a cooler cockpit. During the curing process of the 7 protective film layers you may notice changes in the optical clarity which results in a cloudy appearance. If this happens, it is normal and will go away. After the moisture dries, the hazy appearance will disappear as the film bonds to the glass. Note that with a newer boat in a cooler climate the drying time may be accentuated. Average drying or curing time is 45-60 days after initial installation.

Cleaning instructions for treated windows;

1. Use a soft towel, cloth or clean synthetic sponge.
2. Do not use solutions that contain abrasive materials.



Cosmetic Care & Maintenance

MAINTENANCE



This section covers maintenance procedures on selected standard and optional Regal installed and/or related equipment. Engine and propulsion equipment, electronic and specific entertainment components are found by referring to individual vendor information located in the owner's

information packet.

The engine/propulsion and generator owner's manual are quite detailed and should be read and understood before attempting to undertake any maintenance issues. Heed special attention to all caution, warning and danger labels found in the engine/propulsion and generator manual. Also, the major electronic and entertainment components are outfitted with detailed system descriptions, wiring schematics, and contact information. The internet can be helpful for select maintenance issues.

Numerous web-sites are currently available from vendors on their particular product maintenance procedures and schedules.



AIR CONDITIONER:

Before each outing inspect the thru-hull fitting for leaks. Make sure the seacock is open. Also, the sea water strainers located under the engine room center walk-thru should be checked periodically for foreign objects and accumulated debris. To clean the strainer, first position the seacock handle to the “off” position. Unscrew the strainer fasteners by turning counterclockwise, remove the wire strainer, and blow it out if possible with compressed air. Reinstall the strainer, make sure the gasket on the top of the seacock is centered, and tighten the fasteners. Check for leaks since sucking air into the system could cause the seawater pump to malfunction. See the illustration.

Inspect the air filter monthly. The air conditioner filter is located at the condensation unit at both forward and aft A/C units. To clean the filter remove it and rinse with plenty of fresh water. Blow with compressed air as needed.

Check the AC hose output located on the hull side insuring there is a full discharge when the AC pump is running. If there is little or no discharge shut down the unit and immediately find the cause of the problem.

Periodically check the drain located at the compressor to make sure the entrance to the hose at the AC pan is not clogged with foreign matter.

If clogging occurs, blow out the hose with compressed air and pour in a bleach/water solution at 5/1 parts water to bleach.

Be sure to read and understand the A/C owner’s manual before attempting any maintenance. It covers the operating system and equipment more thoroughly than can be done here. Pay close attention to all safety labels since both high pressure and high voltage are part of the A/C system.

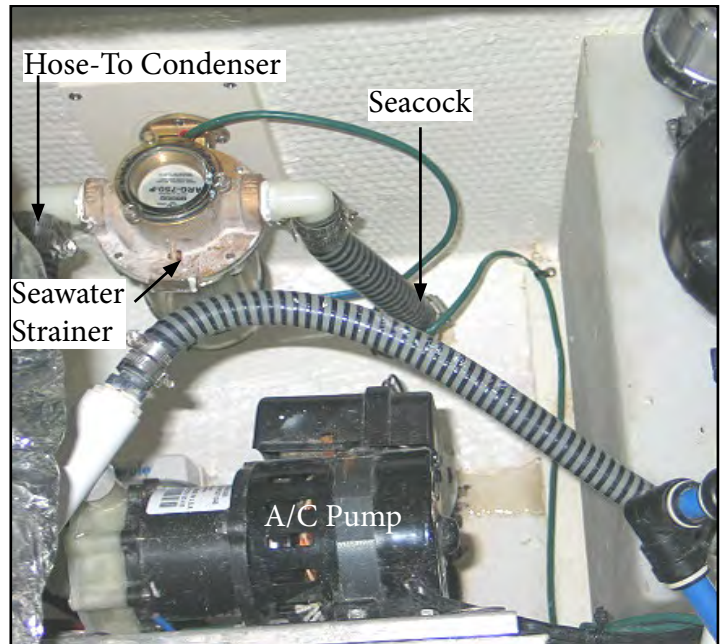

TYPICAL COMPONENTS SHOWN

WARNING

TO PREVENT BODILY INJURY OR DEATH!
DISCONNECT THE A/C BREAKER AT THE
MAIN A/C PANEL BEFORE OPENING ANY
COVER ON THE A/C UNIT.

WARNING

TO PREVENT BODILY INJURY OR DEATH!
DUE TO THE HIGHLY PRESSURIZED
REFRIGERANT FOUND IN THE AIR
CONDITIONER UNIT, DO NOT LOOSEN
OR REMOVE ANY FITTINGS.

REVERSING VALVES

All reverse cycle units use a reversing valve: the valve must be energized periodically to keep the internal parts moving freely. To do this, switch the AC unit into heat for a few seconds once a month.

SEAWATER STRAINER

Check the AC pump for proper seawater flow by cleaning the seacock strainer basket. Check the overboard discharge for proper water flow. Check seawater intake speed scoop for obstructions. Make sure hoses are not looped, kinked or crushed.



Cosmetic Care & Maintenance

TYPICAL VECTOR COMPACT AC SYSTEM

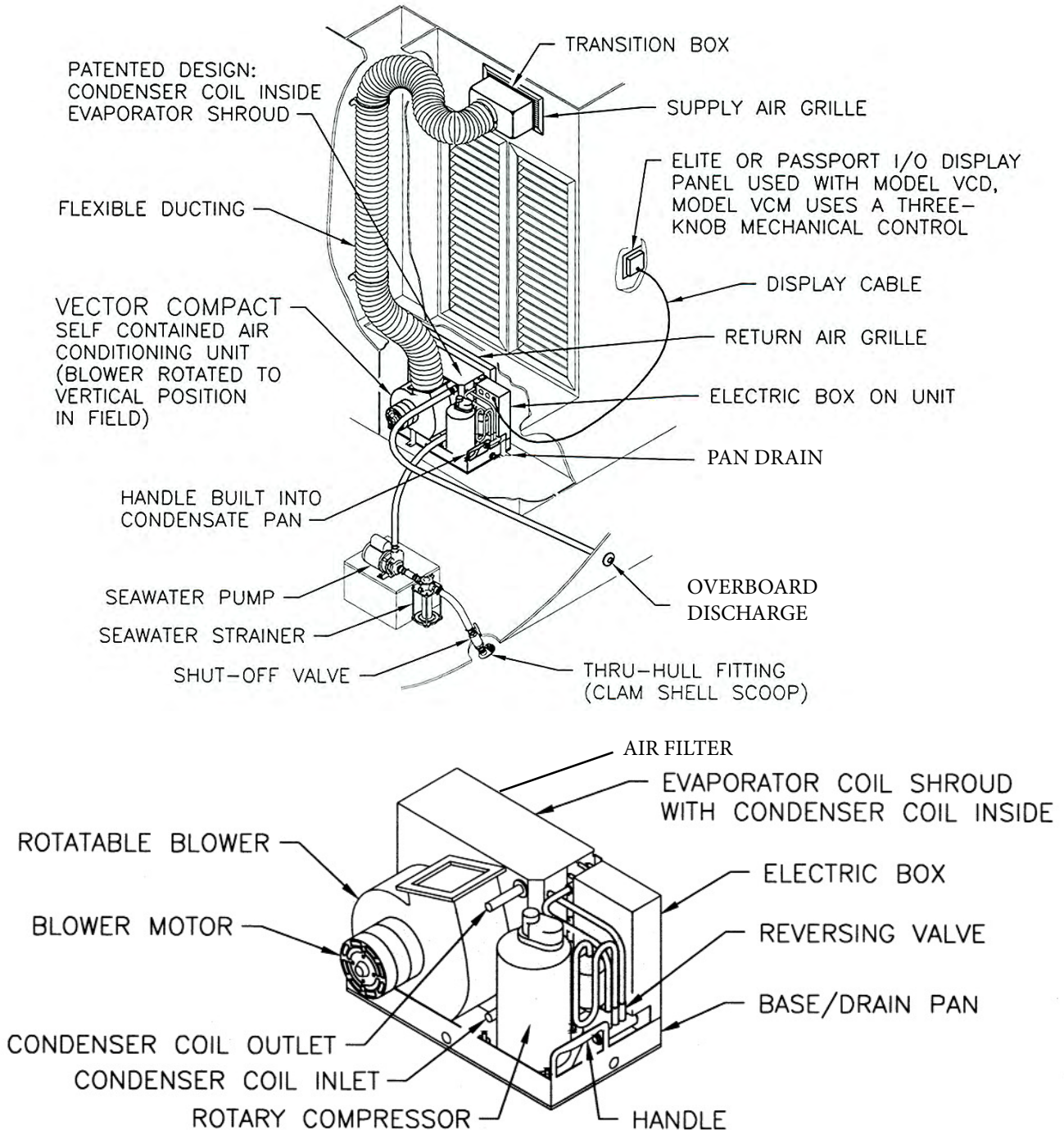



CONDENSER COIL CLEANING

Note: It is best to get an air conditioning expert familiar with marine a/c to do the periodic maintenance mentioned below. The information will assist the technician.

1. With the system turned off at the ship's AC electrical panel, disconnect the inlet and outlet connections of the condenser coil.
2. Use chemical resistant hoses (MAS white PVC 5/8" I.D., etc.) to connect the inlet of the condenser coil to the outlet of a chemical resistant, submersible pump (MAS P-500 pump, etc.) and let the hose connected to the coil outlet flow freely into the container mentioned below.
3. Place a strainer or piece of screen over the inlet of the pump and submerge the pump into a container filled with a 5% solution of muriatic or hydrochloric acid and fresh water or use a premixed over-the-counter solution. Use as large a container as possible to hold the solution (2 to 5 gallons).

5. Circulate fresh water through the coil to flush any residual acid from the system.
6. Restart the system and check operational parameters to ensure thorough cleaning has taken place. Additional cleaning may be necessary with extreme contamination.

NOTICE

FOR THE PURPOSE OF PROTECTING
THE ENVIRONMENT,
DISPOSE OF ANY CONTAMINATED
ACID SOLUTIONS IN ACCORDANCE WITH
FEDERAL, STATE AND/OR LOCAL
REGULATIONS



CAUTION

AVOID BODILY INJURY!
AVOID SPILLING OR SPLASHING
THE SOLUTION.
FOLLOW THE WARNINGS
AND RECOMMENDATIONS GIVEN
BY THE MANUFACTURER
OF ANY ACIDS
OR PREMIXED SOLUTIONS.

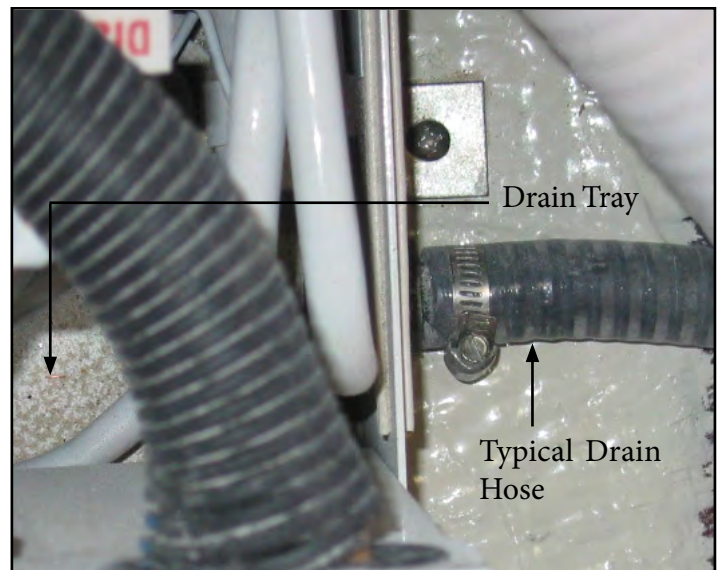

4. Power the pump and circulate the solution through the condenser coil for 15-45 minutes depending on the size of the coils and the extent of the contamination. Visual inspection of the solution in the container should indicate when the contamination removal has stopped.

AIR FILTERS

Check the A/C system air filters monthly. To clean the filter, remove it from the unit, rinse with water, air dry and reinstall. See chapter 7 for filter locations.



Cosmetic Care & Maintenance

BATTERIES

Periodically check your battery terminals for corrosion build-up. If you find a greenish, powdery substance, remove the cable connections and clean both the terminals and the connectors with a wire brush. When the cleaning is finished reconnect the battery cables and coat the terminals with an approved grease or petroleum jelly to help prevent further corrosion. Check the electrolyte level at least every 30 days, more often in hot weather. The level should be maintained between the top of the battery plates and the bottom of the fill cap opening. Add distilled water as needed after charging the batteries. Do not overfill because sulfuric acid could run over and cause burns or an explosion. Check specific gravity levels with a hydrometer which can be purchased at auto retail stores.



Typical Engine Batteries

Tighten all battery connectors securely. Check their tightness by pulling on the connectors. They should not move from their tightened position. Be sure to reinstall the positive boot over the battery terminal after tightening the battery post connection. While using the boat, keep an eye on the volt meters to monitor the charge level of each battery bank. Monitor the charge with the engines turned off (static condition).

The engine alternators recharge the batteries. A fully charged battery will indicate between 12 and 14 volts on the voltmeter. Readings below this could indicate a dead battery cell or a charging system malfunction which should be checked by a marine professional.



WARNING

TO PREVENT BODILY INJURY!
WEAR GOGGLES, RUBBER GLOVES
AND A PROTECTIVE APRON
WHEN WORKING WITH A BATTERY.
BATTERY ELECTROLYTE CAUSES SEVERE
EYE DAMAGE AND SKIN BURNS.
IN CASE OF SPILLAGE,
WASH AREA WITH A SOLUTION OF
BAKING SODA AND WATER.

Batteries should be charged outside the boat. Do not smoke or bring flames near a battery that is being or has recently been charged. The hydrogen gas generated by battery charging is highly explosive.

Set the batteries on a block of wood not concrete since the batteries will lose their charge if left on a cement surface. Do not allow a metal object or loose wires to spark across battery posts while working close to the battery. Contact across terminals will cause a short circuit and possible electrical burns, fire, explosion or personal injury.



WARNING

TO PREVENT BODILY INJURY!
BATTERIES CONTAIN SULFURIC ACID
(POISON) WHICH ALSO CAN CAUSE BURNS.
AVOID CONTACT WITH THE SKIN,
EYES & CLOTHING.
IF CONTACTED,
FLUSH WITH WATER AT LEAST 15 MINUTES.
IF SWALLOWED,
DRINK LARGE AMOUNTS OF WATER OR
MILK. FOLLOW UP WITH MILK OF MAGNESIA,
BEATEN EGG OR VEGETABLE OIL.
GET MEDICAL ATTENTION IMMEDIATELY!



BATTERY MAINTENANCE

Maintenance Free Type

The Group 31 “maintenance free” engine cranking batteries are not all together maintenance free. Unlike regular batteries there are no water fill caps to remove on this style battery but several other items need to be monitored periodically.

1. Check both positive and negative terminal hardware for tightness. Loose connections are known to discharge a battery very quickly.
2. Make sure all terminals are clean. If not a battery cleaner tool (available at car parts stores) or old toothbrush should be used to clean both the positive and negative terminals. Use a small amount of baking soda and water. Remove any residue from the terminal area with a disposable damp cloth.
Install corrosion protection to the posts before reinstalling the terminals. Refer to the illustration.
3. After all preventative maintenance is completed slide the red boot back over the positive terminal. This will prevent any object from arcing across the positive terminal to ground possibly causing a fire.

House- (Fill Cap Type)

The single house “deep cycle” house battery located in the blue and white battery box needs periodic maintenance for optimum performance. Remove the cover by turning the 2 white knobs in a counterclockwise direction. Since this type of battery features fill caps each cell’s water level can be monitored and distilled water can be added as needed. Follow these maintenance steps for the house battery.

1. The first item to be checked is the open-cell voltage. Use a dedicated battery tester or a voltmeter. With the battery fully charged with no circuits energized the voltage across the terminals should be 12.5 to 12.6 volts.



Cosmetic Care & Maintenance

If the battery is not completely charged, but still adequate to crank the engine over, you may see a reading closer to 12 volts.

2. If the battery shows less voltage or will not charge up completely it's time to use a hydrometer. This device checks the proportions of sulfuric acid and water in the electrolyte which is a precise indication of the level of charge. Check all cells. If the readings are below 75% charge the battery. If the electrolyte level is too low to read with a hydrometer, add distilled water only (tap water will eventually ruin a battery's capacity) to any cells in which the electrolyte isn't touching the bottom of the fill port. Do not overfill any cells.

Take another hydrometer reading the following day after the boat has been run and the distilled water has had an opportunity to mix.

If the level of electrolyte is very low, suspect that your yacht's charging system may be generating too high a voltage. The maximum voltage you should see across the battery terminals with the engine running as read by a voltmeter well above idle is 14.6 volts.

3. Check both positive and negative terminal hardware for tightness. Loose connections are known to discharge a battery very quickly.

4. Make sure all terminals are clean. As discussed earlier, a battery cleaner tool along with a toothbrush should be used to clean both the positive and negative terminals. Use a small amount of baking soda and water. Remove any acid residue from the terminal area and battery top with a damp cloth. Be sure to wear plastic gloves and eye protection. See the illustration.

Install anti-corrosion protection to the posts before reinstalling the terminals. This lubricant is available as a paste or spray type and can be found at most marina or auto supply stores.

Be sure to reinstall any red (+) battery (anti-short) boots.

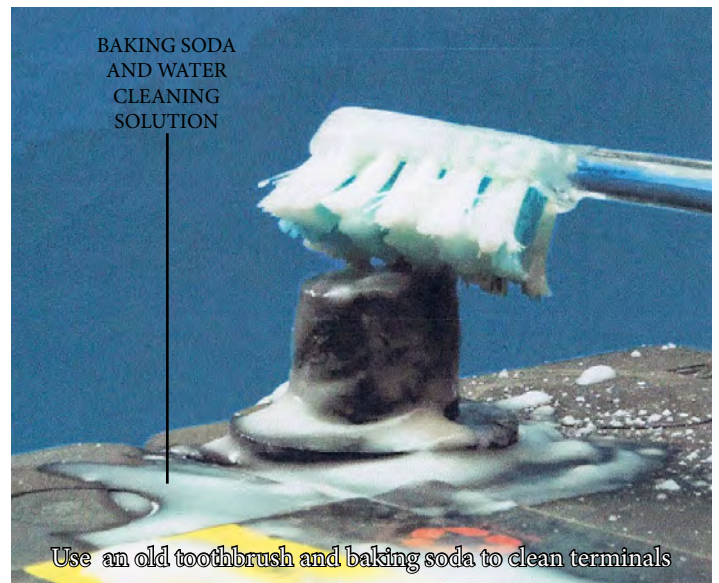



CAUTION

AVOID EYE DAMAGE/SKIN BURNS!
WEAR GOGGLES & RUBBER GLOVES
WHEN WORKING WITH BATTERIES.

AVOID CONTACT WITH SKIN,
CLOTHING OR EYES.

IN CASE OF CONTACT,
FLUSH WITH WATER
FOR AT LEAST 15 MINUTES.

IF SWALLOWED,
DRINK LARGE QUANTITIES
OF WATER OR MILK.

FOLLOW WITH MILK OF MAGNESIA,
BEATEN EGG OR VEGETABLE OIL.
GET MEDICAL ATTENTION IMMEDIATELY.



CAUTION

TO PREVENT BATTERY ARCING
FIRST REMOVE THE NEGATIVE BATTERY CABLE
FROM THE BATTERY.



Cosmetic Care & Maintenance

BATTERY PARALLEL SWITCH

If the battery parallel switch fails to operate, check the breaker located inside the starboard helm locker. Always find the cause of the problem before resetting the circuit breaker.

A second area to investigate is the battery parallel solenoid located in the engine room. When the switch is pressed the solenoid energizes the appropriate second battery for additional engine cranking capability.

Normally, if you hear a solenoid click it is operating properly. Check all solenoid and battery connections for tightness.

BATTERY SWITCH PANEL

If the battery switch (DC distribution panel) should lose power to one of the batteries, check the breakers close to that battery switch. Look for a “popped breaker. The above problem could be recognized by the appropriate icon not being lighted at the DC distribution panel. These breakers protect the charging/battery circuitry. Always find the cause of the overload before resetting the circuit breaker.





TYPICAL BILGE PUMP/FLOAT SWITCH

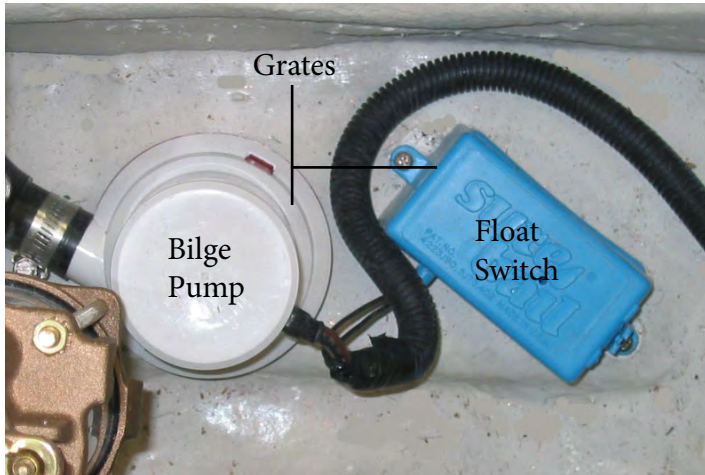

Your vessel offers as standard equipment a bilge pump service. Periodically check the grates for debris and test spray the units down with water. Make sure that a steady stream of water exits the through hull fitting indicating the hose from the bilge pump itself is clear. Periodically check all hoses, clamps and electrical connections for tightness.



SLIDING GLASS DOOR-SALON ENTRY

Periodically clean the lower door tracks since debris can clog the track resulting in a door that may jerk instead of slide to open or close. Use a vacuum or a soft damp cloth. Lubricate the latch and lock mechanism sparingly with a powdered graphite available at the big box stores. Stick the tube in the key hole and squirt in the graphite. Wipe off any excess with a soft cloth.

ELECTRONICS-GARMIN

General Maintenance

Since there are no user-serviceable parts on electronic products they should be serviced only by specific marine electronic certified factory technicians.

Some products generate high voltages, and so never handle the cables/connectors when power is being applied to the equipment.

When powered up, all electrical equipment produces electromagnetic fields. These can cause adjacent pieces of equipment to interact with one another, with a consequent adverse effect on operation. In order to minimize these effects and enable you to get the best possible performance from your electronic equipment, guidelines are given in the installation instructions, to enable you to ensure minimum interaction between different items of equipment, i.e. ensure optimum Electromagnetic Compatibility (EMC).

In some installations, it may not be possible to prevent the equipment from being affected by external influences. In general this will not damage the equipment but it can lead to spurious resetting action, or momentarily may result in faulty operation.

Certain atmospheric conditions may cause condensation to form on the instrument window. This will not harm the instrument and can be cleared up by increasing the illumination setting.

Periodically clean any electronic display screens with a soft damp cloth. Do not use any harsh chemicals, solvents or abrasive materials to clean the instrument.

Note: For detailed information on each component refer to your electronics owner's manuals in the owner's information packet. Also, the vendor can be found on-line or phone your closest Regal yacht dealer.



ELECTRONICS-VHF RADIO

If installed the VHF marine radio has been constructed to be virtually maintenance free. With a little attention to a few basic care points, the unit should provide years of service.

1. Although the unit is waterproof by design, keep it as dry as possible. When cleaning the cockpit, never use a direct water nozzle on the unit.
2. Clean the exterior with a soft, non-abrasive cloth.
3. Do not use any solvents or other chemicals for cleaning the VHF radio.
4. Periodically inspect the radio case, electrical wiring and antenna for physical damage.

Note: For further information refer to your electronics owner's manuals in the owner's information packet. Also, the vendor can be contacted on-line or phone your closest Regal dealer.



FIRE EXTINGUISHING SYSTEM - AUTOMATIC

Inspect the pressure gauge before each outing. The illustration shows the ready and discharge condition of the actuator. Remove and weigh the unit (minus brackets) every 6 months on an accurate scale (Do not use any hand held scales). If weight is below that shown on the unit nameplate, it must be removed from service immediately. If leakage is suspected, brush liquid soap on all points of possible leaks, or submerge entire unit in clean fresh water and watch carefully for 5 or 10 minutes. Leaks will appear as tiny bubbles. If leakage is found return to the factory immediately for repair or replacement. Remember the two most important requirements to assure full charge and reliability of your Fireboy system are:

1. Visual inspection of the gauge and the actuator to determine if it has actuated.
2. Weighing to determine the true contents of the agent in the system.

All models from 75 cubic feet are re-chargable. Recharging is possible only if the unit has leaked out verses losing agent due to a fire.

Should the indicator light fail to come ON when the ignition key is ON, first check the pressure gauge and actuator to see if the unit has discharged. If not check the breaker. Next, using a continuity tester, check the electrical pressure switch on the system bottle itself. Pull the molded rubber connector off by pulling straight away from the manifold, and place the probes of the continuity tester directly on the spade connectors. This pressure switch should show a closed circuit.

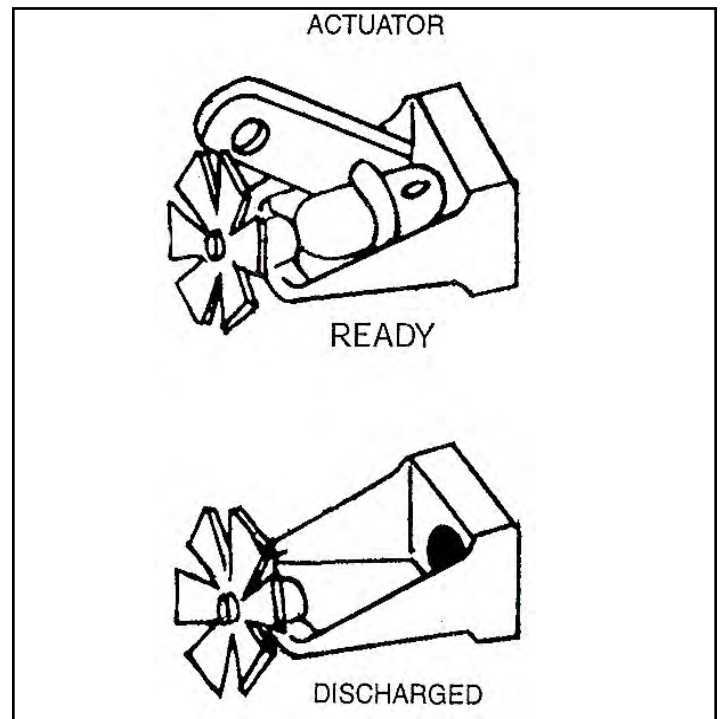

Next, check the continuity of the entire wiring circuit. The indicator lamp is an LED (light emitting diode) and cannot be tested with a continuity tester.

A simple method to test LED'S is to remove the lamp and touch the red wire to the + terminal and the black wire to the - terminal of an ordinary 9 volt battery. Should the indicator lamp be faulty, replacement lamps are available from Fireboy.

Should the continuity of the pressure switch indicate an open circuit, the system will have to be returned to the factory for either replacement or repair.



Cosmetic Care & Maintenance

FUEL SYSTEM

Periodically (at least twice annually) inspect the fuel tank components for loose clamps at the vent, fill, return and feed locations. Examine each hose for signs of deterioration and leakage. Check the fuel sender for loose fasteners and leaks at all areas of contact. Also, inspect the fuel tank for signs of leakage or abrasion. Tighten all components as needed.

Note: Do a visual inspection before each cruise. Again, include the high pressure diesel engine fuel hose components along with the diesel fuel filters both in-line and connected to the engine. Also, with dual fuel tanks check the diesel fuel transfer pump connections.



GENERATOR/ DIESEL-TYPICAL

Overview

Your vessel features a diesel generator. Read and become familiar with the generator owner's manual. It provides a variety of operational, safety and troubleshooting information. The output voltage under a full load can be easily periodically checked by observing the AC voltage meter found on the AC/DC panel. The output voltage should be between 110 -120 volts AC (60 hertz-US), and 220- 240 volts AC at (50 hertz- International). Voltages outside these specifications could indicate a generator malfunction. Make sure all fluid levels are checked before starting the generator. The generator seacock handle must be in-line with the seacock and the sea water strainer must be free from debris.

The generator features an automatic shut down system of sensors controlling high exhaust temperature, high water, low oil pressure, and high RPM. If one of these sensors engages, the generator will shut down. The source of the problem then needs to be determined. Use the owner's manual troubleshooting section as a reference.

There is a fuel filter in the system that periodically needs checking and cleaning. Refer to the owner's manual.

Disconnect the battery cables before doing any generator maintenance. Inspect and clean the carburetor flame arrestor periodically by blowing off with compressed air. Inspect all fuel system fittings for leakage periodically. Be sure proper ventilation is present when servicing the fuel system components. Inspect all water and heat exchanger fittings periodically for leaks. Repair or replace components as needed. Be sure the generator is completely cold before performing any maintenance on the water system due to possible hot water and or antifreeze filled components. Be sure to catch and dispose of any antifreeze coolant properly. Refer to the generator owner's manual regarding antifreeze recommendations for type and mixture concentrations.

There is a zinc anode located in the raw water part of the heat exchanger. Replace if 50% eroded. It is self sacrificing thereby reducing the effects of electrolysis to the generator water system.

Check the drive belt deflection with the generator stopped. At the longest span, push down at the center. You should generate a movement of 3/8 to 1/2 inch. Refer to the generator manual for more information.

When refilling the crankcase with oil follow the specifications given in the owner's manual. Dispose of used oil in an environmentally friendly manner. Following are selected detailed maintenance functions on the diesel generator. Refer to the generator owner's manual for more information.

Note: Read and understand the following safety warnings before performing any maintenance procedures.



WARNING

AVOID SERIOUS INJURY FROM
ACCIDENTAL GENERATOR STARTING!
DISCONNECT THE BATTERY CABLES
BEFORE WORKING ON THE GENERATOR.



WARNING

AVOID SERIOUS INJURY FROM A HOT
GENERATOR AND EXHAUST SYSTEM.
DO NOT WORK ON GENERATOR
UNTIL THE UNIT COOLS.



WARNING

AVOID SERIOUS INJURY
FROM ROTATING PARTS!
OPERATE THE GENERATOR ONLY
WHEN ALL SCREENS, COVERS &
GUARDS ARE IN PLACE.



Cosmetic Care & Maintenance

TYPICAL DIESEL GENERATOR PARTS DESCRIPTION

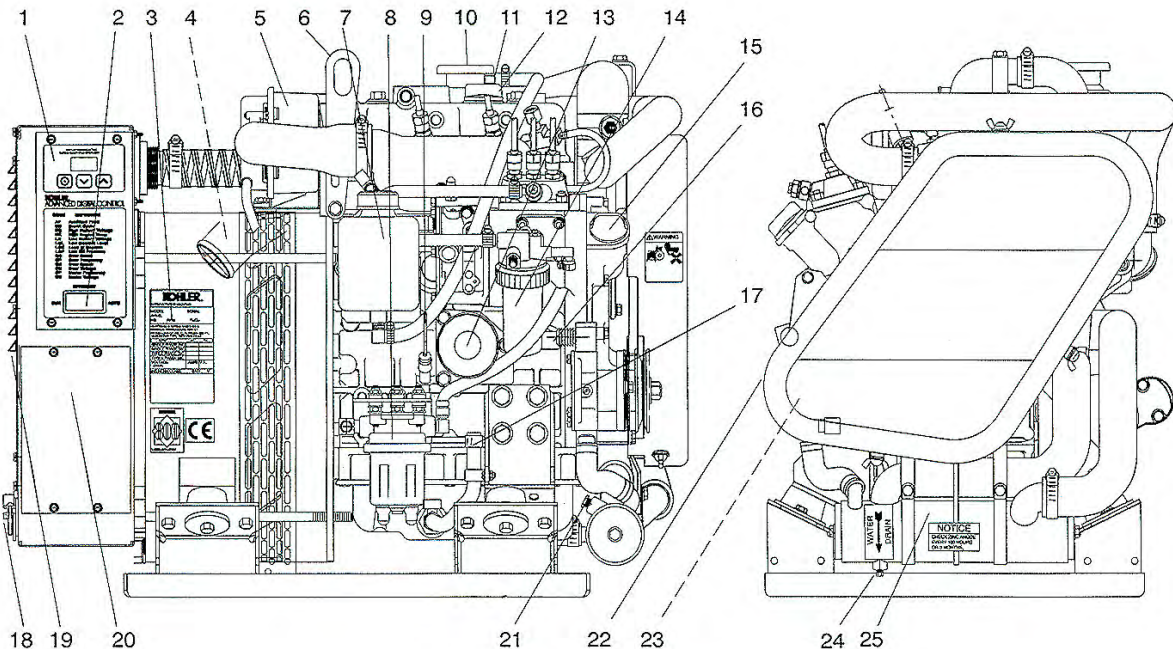

13-24EOZD & 11-20EFOZD Models Non Service-Side View

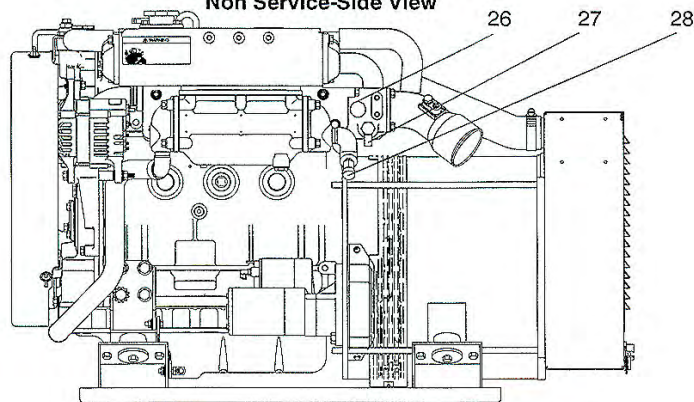

- | | |
|---|---|
| 1. ADC 2100 Control | 17. Oil drain valve and hose |
| 2. Run-Off/Reset-Auto switch | 18. Strain relief for the load lead cable |
| 3. Nameplate | 19. Alternator cooling air inlet |
| 4. Mixing elbow (water outlet/exhaust outlet), far side | 20. AC circuit breaker panel |
| 5. Air intake silencer/cleaner | 21. Anticorrosion zinc anode (seawater drain) |
| 6. Lifting eye | |
| 7. Coolant overflow bottle (location varies by model) | 22. Belt guard |
| 8. Fuel feed pump | 23. V-belts |
| 9. Oil check/dipstick | 24. Engine coolant drain (all models except |
| 10. Coolant pressure cap | 25. Heat exchanger (all models except 13-24EOZD & |
| 11. Coolant overflow tube | 26. Heat exchanger (13-24EOZD & 11-20EFOZD models, internal |
| 12. Oil fill (engine top) | to exhaust manifold) |
| 13. Lube oil filter | 27. Seawater drain (13-24EOZD & 11-20EFOZD models) |
| 14. Fuel filter | 28. Engine coolant drain (13-24EOZD & 11-20EFOZD models) |
| 15. Oil fill (front gear cover) | |
| 16. Seawater pump and water inlet | |



Cosmetic Care & Maintenance

GROUND FAULT OUTLET:



The GFIC (Ground Fault Interrupter Circuit, GFIC abbreviated) outlets should be tested monthly. To test the unit, depress the reset button. Then press the test button. The reset button should pop out.

If it does not, contact a qualified electrician or marine professional to replace the device.

Refer to Chapter 4 where it explains the system operation and shows the circuitry throughout the

vessel. The GFIC is normally located at the beginning of a circuit so that all receptacles further down the circuit are protected. That could be a reason why several components plugged into outlets will not work when a GFIC is not functioning.

Note that selected units show a black GFIC duplex and mounting plate.



HEATER-HOT WATER

A. The most important maintenance factor with the hot water heater is that it is winterized with Winterban (RV anti-freeze; alcohol style) in freezing climates. Use the water heater drain valve to vacate water from the tank. The water will automatically drain into the shower sump pump and then will be sent overboard. Make sure the water heater breaker is turned off before any winterization is started to prevent the element from being burned out.

B. If the system is constantly being used in warmer climates it is a good idea to periodically drain the hot water valve for 30 seconds or so to eliminate any scale that has built up inside the hot water heater. Turn the breaker off just as a precaution.

C. The hot water heater and heat exchanger parts are made of aluminum. If engine flushing is required by the manufacturer be sure to disconnect the heat exchanger from the system temporarily. The caustic chemicals will damage the hot water heater aluminum parts. Re-plumb the heat exchanger back after engine flushing.

D. Test the T&P valve periodically to make sure it works properly. Its purpose is to let off excess water vapor (steam) if the thermostat should stick and a critical temperature situation develops within the tank. Pull on the valve to test it. The water will vacate to the shower sump pump and then overboard.

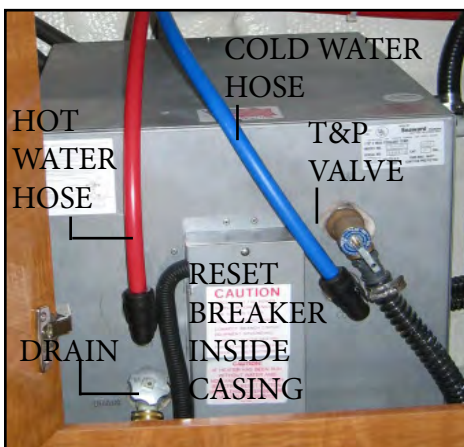



Cosmetic Care & Maintenance

HIGH WATER ALARM

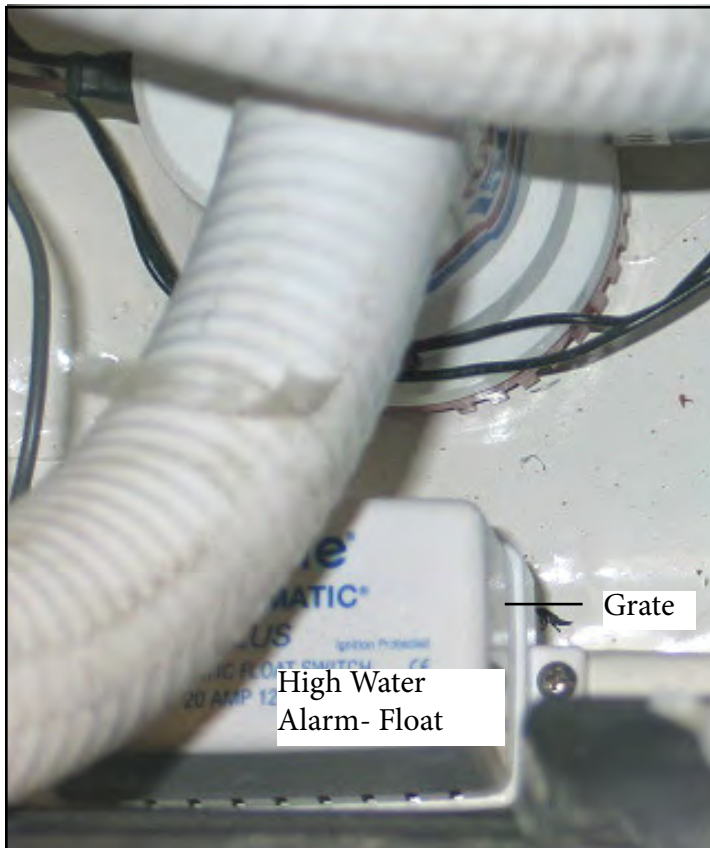

The high water alarm float is located in the engine room. Periodic maintenance consists of visually inspecting the float grate cover for debris and removing any accumulation.



WARNING

TO PREVENT BODILY INJURY OR DEATH
NEVER USE AUTO ANTIFREEZE IN A MARINE
WATER SYSTEM OR ANY OF ITS PARTS.
AUTO ANTI-FREEZE IS HIGHLY TOXIC
AND POISONOUS TO THE HUMAN BODY.



HORN (TYPICAL AIR OPERATED)



The typical air horn set features an air pump which is located under the salon whisper wall ceiling covering. The horns emit a sound that can be heard much louder than the typical electrical horn. This extra distance capability can be useful in ship to ship crossings especially when foul weather is present.

Check the horn assembly for debris and insect nests periodically. Use an auto grade chrome cleaner on the horn assembly at least 2 times annually. After each cruise, rinse the horn assembly with fresh water. Check the fasteners for tightness annually along with the deck sealant for complete sealing coverage.



Typical Air Horn Pump

Normally the air horn pump requires no maintenance. If problems exist contact your closest Regal dealer.



OIL CHANGE SYSTEM

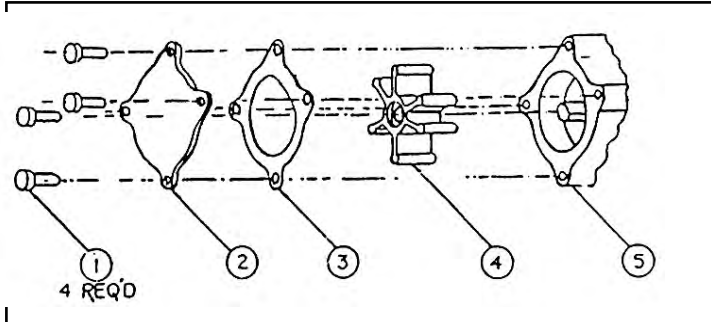

The oil changer system requires little maintenance up to the 500 hour period. At that time the impeller needs to be replaced. Earlier replacement may be necessary if the oil changer has been operated dry, foreign objects have broken the impeller vanes down, or improper liquids have been run through the system. For impellers and gaskets, call 1-800-922-4804.

To change the impeller:

1. Remove the four screws(1).
2. Remove the cover plate (2) and old gasket (3).
3. With fingers, remove damaged or worn impeller (4).
4. Clean the inside of the pump looking for foreign materials and any partial impeller vanes that may be stuck in the chamber. Also, check the hose barbs and hoses leading to the outside for debris.
5. Apply Vaseline or similar lubricant to both the inside of the pump head (5) and to the outside of the impeller (4).
6. Align the flat surface on the inside of the new impeller with the flat surface on the motor shaft. Push into place while twisting the blades in a clockwise direction.
7. Place the new gasket (3) on the pump body face, align holes and replace cover (2). Tighten all 4 screws evenly.



PLUMBING CONNECTORS

Plumbing connections to the red and blue fresh water lines require special instructions when they are to be removed or replaced. Be sure to turn off the water for that circuit at the manifold before starting any plumbing repairs.

1. To remove a tee, 90 degree, or straight connector fitting first remove the cap on the end of the fitting by using a slotted screwdriver. Insert the screwdriver in the cap slot and turn 90 degrees. Cap will release from the fitting.

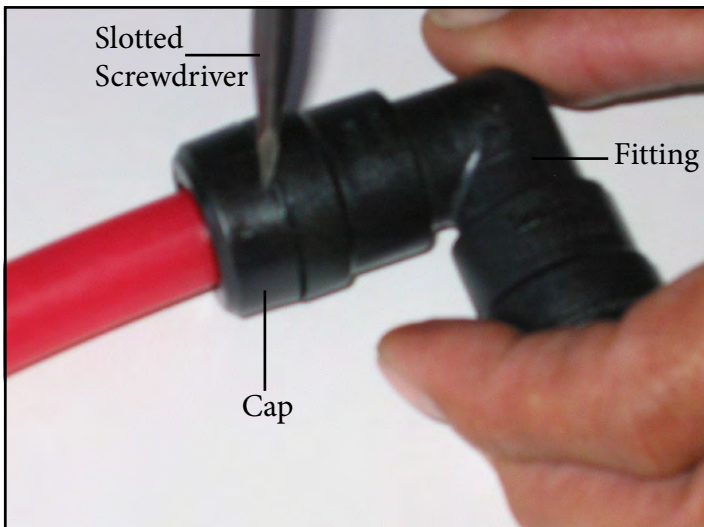

2. Push the connector and collar together. Hold the collar next to the connector with your finger. Pull and the connector/collar will release itself from the water line.

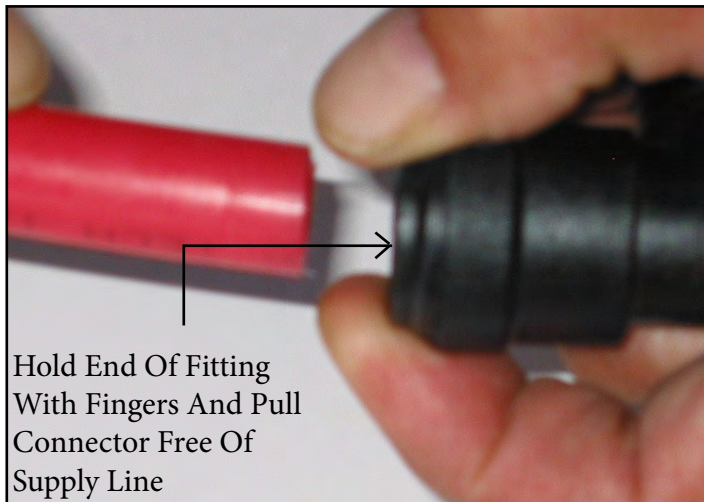

To reinstall a plumbing connection to a water line make sure the line is cut off square and the end is smooth. This will aid in ensuring a leakproof connection.

1. Install the cap on the supply line. You may need to use a slotted screwdriver to remove the cap from a new fitting.
2. Simply push the fitting on to the supply line until pressure is felt. This ensures it is completely in the fitting.
3. Push the cap on the collar until it snaps in place. Turn on the water pressure and check for leaks.

Note: With the connector in place, a movement between the line and connector is normal.



Cosmetic Care & Maintenance

PRESSURE PUMP-FRESH WATER

The fresh water system in general requires very little maintenance.

1. See the equipment operation chapter defining the recommended seasonal disinfection procedure.
2. The fresh water filter needs to be cleaned periodically. Simply remove the hose clamp and unscrew the fresh water filter to access the screen. Rinse the screen off to remove any foreign debris. Be sure to use teflon tape on the pump fitting threads before installing the filter. Reinstall the components and check for leaks.
3. Periodically check all fittings for leaks.
4. In colder climates, use Winterban or its equivalent in all the fresh water system components after draining the system.
5. Select units use a fuse located at the positive pump wire.

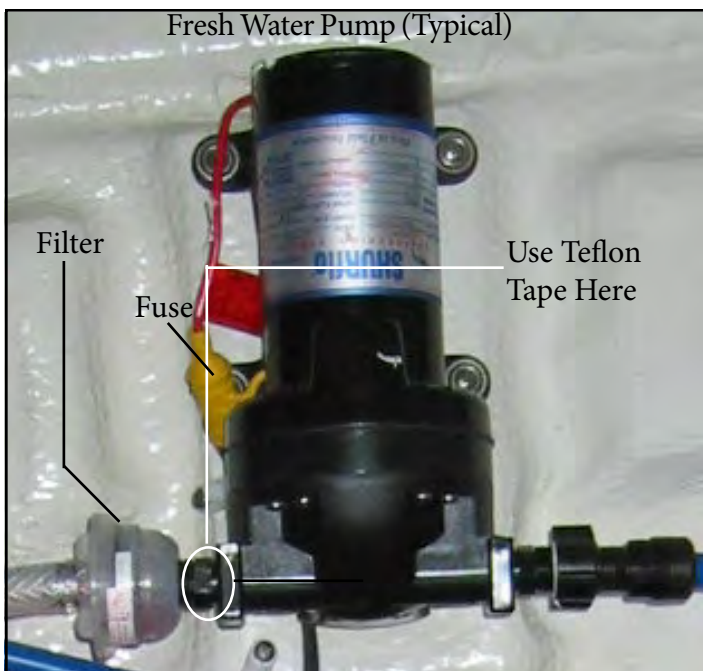



PUMP-OVERBOARD DISCHARGE



If your boat is equipped with an overboard discharge pump pay close attention to what materials are flushed through the waste system as it could become clogged. Do not pump garbage, rags, or sanitary napkins through the overboard discharge pump (macerator). Flush the waste tank and pump with fresh water with each pump out. Do not run the pump dry or for extended periods of time since the impeller can be damaged.

Pump the waste system out at decommissioning time and rinse fresh water through the entire system periodically to keep the hoses clean of debris especially the pump out hose.



STEREO/DVD PLAYER/TELEVISION

Since most of the same cleaning and maintenance tips overlap on these entertainment components, they will be grouped together.

1. To clean the CD slots in stereos, DVD players use a dry or slightly water moistened swab to remove any buildup of debris. This monthly procedure will assist in preventing the CD discs from being scratched.
2. To clean the faceplates of the various units use a dry soft cloth. If the faceplate is stained badly, use a moist cloth with a neutral cleaner. Do not use harsh, caustic or alcohol based chemicals to keep the letters from coming off the faceplate. Do not use silicone spray or WD-40 since they could damage mechanical parts.
3. If these units will not play CD's properly it they may have developed condensation. Wait 1 hour and retry.
4. Keep all remote controls out of extreme heat and high moisture environments. Change batteries often for best operation.
5. Periodically check CD discs for scratched and dirty ones. Clean the dirty ones with a cleaning kit which can be purchased at most electronic stores.
6. With flat screen televisions, do not attempt to service the unit yourself since high voltage exists.
7. To clean the flat screen display, dampen a soft cloth with water or a mild detergent. The best cleaner is a screen cleaning tissue specifically designed for antistatic coating. Never use flammable cleaning materials or glass cleaners with ammonia since they attack the television screen surface.



TELEVISION FLAT SCREEN MONITOR

These cleaning recommendations cover TV's that may be installed in the main cabin, forward and master staterooms and cockpit. Regular cleaning of the these units will help extend their life. Turn the power off at the breaker before you begin any cleaning procedure.

Cleaning The Screen

Wet a soft cloth in a mixture of warm water and fabric softener or dish washing detergent. Wring out the cloth until it is almost dry. Wipe the screen to remove dust and debris.

Remove any excess water from the screen and let the screen air-dry before you activate the television breaker and turn the unit on.

Cleaning The Cabinet

Use a soft, lint-free cloth to clean the cabinet off. Again, do not use a wet cloth.

NOTICE

WHEN LEFT FOR EXTENDED PERIODS
TURN THE TELEVISION BREAKER
TO THE OFF POSITION TO HELP PREVENT
POWER SURGES OR LIGHTNING DAMAGE.

NOTICE

TO PROTECT THE INTERNAL TELEVISION
COMPONENTS OF THE TELEVISION
REMOVE THE TELEVISION FROM THE
VESSEL IN FREEZING CLIMATES.
CONTACT YOUR REGAL DEALER
FOR TECHNICAL SERVICE.



TRIM TABS

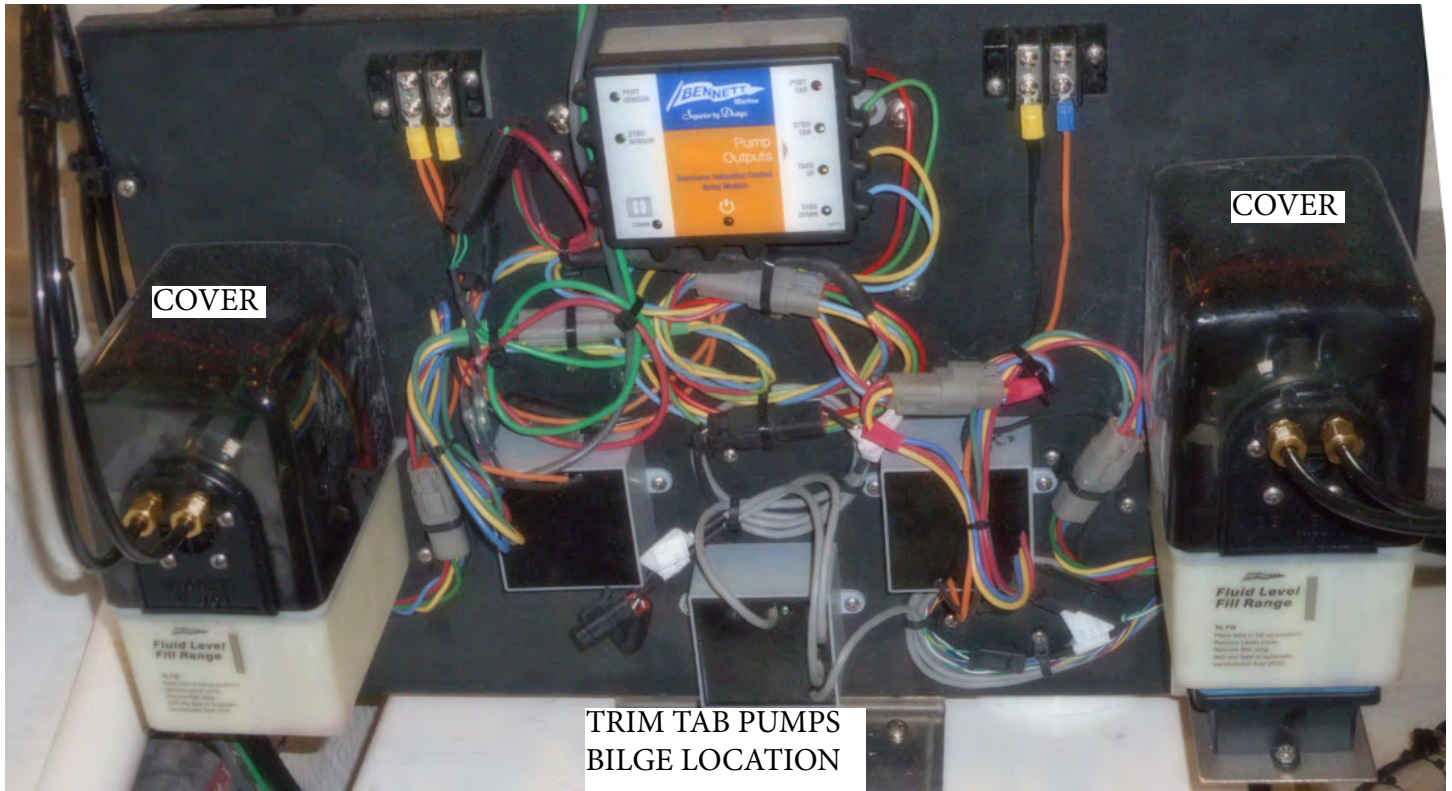

Trim tabs are located on the outer edges of your yacht transom below the swim platform. All mechanical and electrical connections should be periodically checked for tightness, corrosion, and chafing. If a malfunctioning tab is suspected, run each tab in and out while someone looks at each tab to make sure it is moving up and down the proper distance. Replace any zinc anodes mounted on trim tabs when at one half their life as determined by size. Check anodes twice a month.

The trim tabs may be painted for corrosion protection. Do not paint the anodes as they protect the tabs from galvanic corrosion.

Check the hydraulic power unit fluid (HPU) level. The pumps are located in the bilge (sump) starboard side. To refill, remove the cover and filler plug. Fill with any type automatic transmission fluid (ATF). The fluid level should be 2" from the reservoir bottom.

Note as a safety factor there is a separate pump for port and starboard tabs along with separate electronic system boxes.



Cosmetic Care & Maintenance

UNDERWATER HARDWARE- SEACOCKS & Volvo- Checking V-Drive Sea Water Strainer

Inspect the thru-hull seacocks before each outing. Make sure the connections between the output hose and the valve are tight. Look for water leaks around the area where the valve and hull meet.

Every 30 days open and close each thru-hull valve several times. This will guard against the valve seizing in the open or closed position. Also, make sure the valve handle is tightly fastened. Secure any loose valve handles.

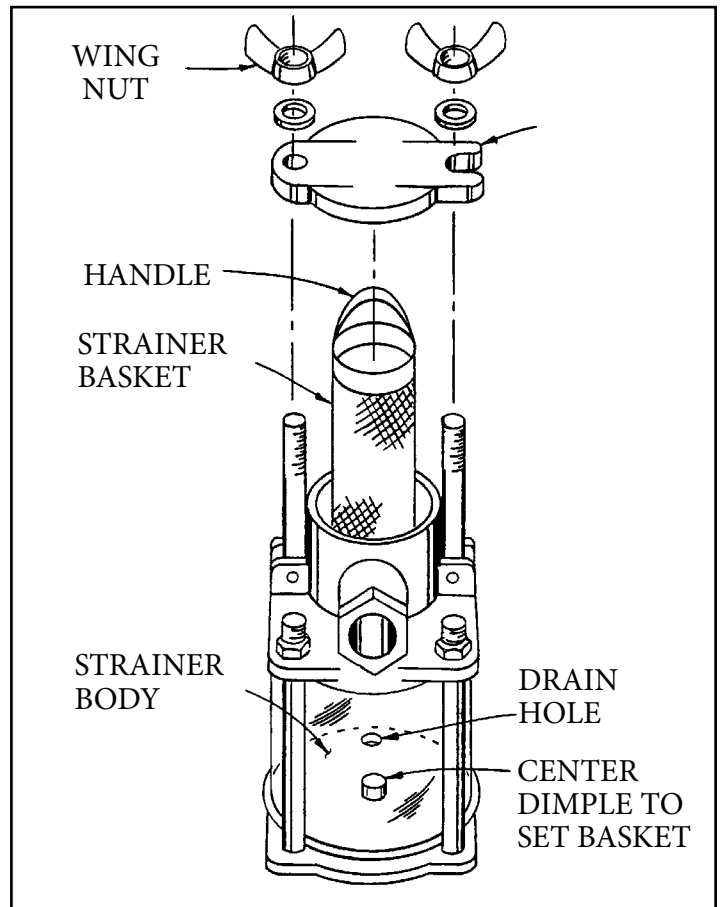
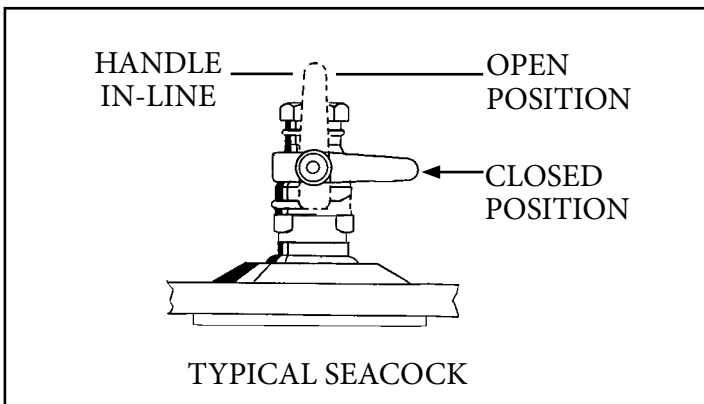

TYPICAL STRAINER

Before servicing the sea water strainer make sure the appropriate seacock has been closed to prevent water entering the boat. If possible blow out the strainer basket with compressed air or use a metal type brush to remove any accumulated material from the screening material. Make sure the strainer is aligned in the center dimple on reinstallation.

Check all parts for wear and possible leaks including any gasket surfaces. Do not overtighten the strainer hold down fasteners which could cause strainer body damage especially on the newer plastic versions. Use original replacement marine parts only. After all parts are reassembled open the seacock and check for leaks. Notice there is a drain hole in the bottom of the strainer body.



TOILET-VACUUM DESIGN

Vacuum style toilet systems need to be cleaned periodically for maximum sanitation and operational efficiency. Clean the bowl with a cleaner such as Bon Ami which will not abrade the toilet bowl lining. Do not use chlorine solvents or caustic chemicals such as drain openers because the various system seals may be damaged.

Use the following procedure monthly or when leaving the vessel for extended periods.

1. Fill bowl with water.
2. Add 1 cup of biodegradable powdered laundry detergent.
3. Flush toilet by pressing the pedal for about 2 minutes. Release foot pedal to close flush ball.
4. Most marinas offer a service that uses a vacuum hose connected to the deck waste fitting that pulls the waste from the tank. We suggest using a hose after the process and shoot a few bursts of fresh water down the waste fitting at the deck. This helps the residue left from the pump-out process from building up in the waste hose.

If an odor is apparent from the system try the following:

1. Clean the system out using the above procedure.
2. Check to see that the vent from the holding tank to thru-hull fitting is not clogged.
3. Periodically add the correct holding tank deodorant either Secure or Sealand liquid.
4. Annually replace the in-line vent waste filter normally located in the bilge. This filter can be ordered from a Regal dealer or your local marine supply store.
5. Refer to the toilet owner's manual for further information.



Cosmetic Care & Maintenance

VACUUM CLEANER

CLEANING STRETCH HOSE

The stretch hose on occasion has a tendency to get clogged especially if you have pets on board. To clean the hose:

1. Lift the hose up at both ends and dispense some liquid detergent into both ends.
2. With a garden hose, holding both ends still up, fill 3/4 with water.
3. Shake hose up and down, let detergent loosen the dirt and clogged debris.
4. Stretch the hose as far as you can (2 people required) and wash the dirt out with the full pressure of a garden hose. Repeat as necessary.
5. Hang hose up on one end. Let hose drain and dry completely.



TYPICAL MAINTENANCE SCHEDULE- VOLVO IPS DIESEL ENGINE



WARNING

AVOID PERSONAL INJURY BEFORE PERFORMING ANY MAINTENANCE WORK READ AND UNDERSTAND THE OWNER'S MANUAL. IT CONTAINS THE RECOMMENDED PROCEDURES.

NOTICE

MAINTENANCE POINTS MARKED WITH A * MUST BE PERFORMED BY AN AUTHORIZED VOLVO PENTA DEALER.

The IPS propulsion package is designed to provide many years of reliability and satisfaction. To keep the unit running at peak performance a service maintenance schedule is recommended. Only basic information is conveyed here. Refer to the Volvo operation manual for detailed information or contact a Volvo authorized service center.

BEFORE EACH OUTING OR DAILY:

- ◆ Engine & Sump- General inspection
- ◆ Engine Oil- Check Level
- ◆ Coolant- Check Level
- ◆ Leaks- Check After Starting Engines
- ◆ Drive Unit Oil- Check Level

EVERY 14 DAYS

- ◆ Drive Belts- Wear Check
- ◆ Seawater Filter- Clean
- ◆ Battery- Check Electrolyte Level

(1) Oil change intervals vary, depending on oil grade and sulfur content of fuel.

EVERY 100-200 HOURS OR YEARLY

- ◆ Engine Oil- Change (1)
- ◆ Engine Oil Filter- Change (2)

EVERY 200 HOURS OR YEARLY

- ◆ Crankcase Ventilation Filter- Change
- ◆ Air Filter- Change
- ◆ Drive Belts- Check Tension
- ◆ Compressor- Check Oil Level
- ◆ Seawater Pump- Check Impeller
- ◆ Sacrificial Anodes- Check Air Cooler, Heat Exchanger
- ◆ Fuel filters- Change
- ◆ Paint- Touch-Up As Needed
- * Exhaust & Cooling Hoses
- * Hose Clamps- Tighten
- * EVC System- Check With Diagnostic Equipment

EVERY 400 HOURS OR YEARLY

- ◆ Drive Unit- Oil & Filter- Change
- ◆ Drive Unit- Corrosion Protection- Check Anodes

EVERY SECOND YEAR

- ◆ Coolant- Change

EVERY 400 HOURS OR YEARLY

- ◆ Drive Unit- Oil & Filter- Change
- ◆ Drive Unit- Wear Check Propeller & Steering

EVERY 600 HOURS OR ONCE EVERY 5 YEARS

- ◆ Turbocharger- Inspect & Clean
- ◆ Drive Unit- Wear Check Propeller & Steering

(2) Always change the oil filter with each oil change.



Cosmetic Care & Maintenance

TYPICAL MAINTENANCE SCHEDULE- VOLVO IPS DIESEL ENGINE

EVERY 200 HOURS OR YEARLY

- ◆ Drive Belt- Change
- ◆ Compressor Oil- Change
- ◆ Drive Belt At Compressor- Change
- ◆ Heat Exchanger Inspection/Cleaning
- ◆ Intercooler- Inspection & Cleaning
- ◆ Exhaust & Water System Hoses- Inspection Of Hoses & Clamps

NOTICE

MAINTENANCE SCHEDULES ON ENGINES OFTEN CHANGE AS IMPROVEMENTS ARE MADE WITH THE PRODUCT. ALWAYS VALIDATE ENGINE INFORMATION FOUND IN THIS MANUAL BY CHECKING WITH AN AUTHORIZED VOLVO DEALER.



VOLVO IPS ENGINE/DRIVE COMMON PARTS IDENTIFICATION

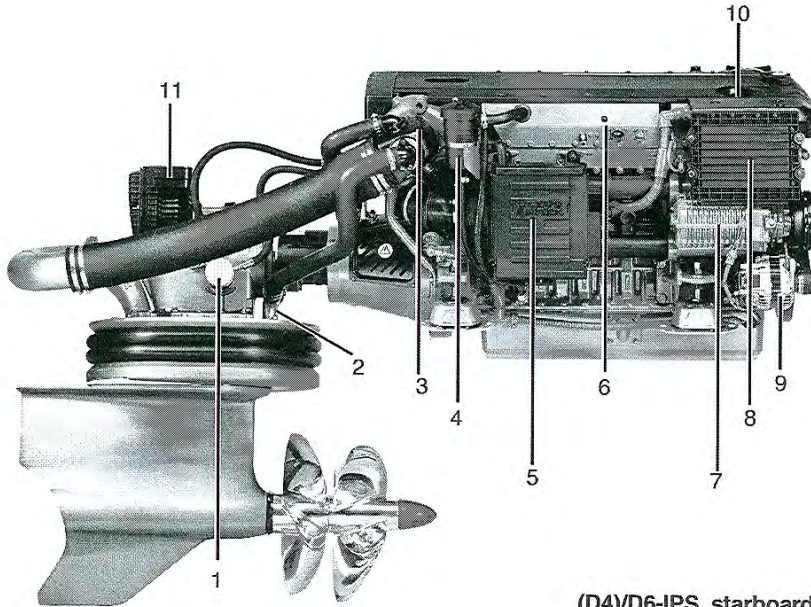

(D4)/D6-IPS, starboard

1. Oil filter, drive-unit
2. Water shut off valve, drive-unit (only D6)
3. Turbocharger
4. Crankcase ventilation filter
5. Air filter
6. Aux stop
7. Compressor
8. Engine control unit
9. Generator
10. Oil filler cap
11. Volvo Penta IPS, Servo Unit Steering (SUS)

D6-IPS, port

12. Sea water filter
13. Sea water pump
14. Fuel filter
15. Oil dipstick, engine
16. Oil bypass filter
17. Oil filter
18. Charge air cooler
19. Cooling water intake
20. Oil dipstick, drive-unit
21. Water shut off valve (drive-unit)
22. Oil filler cap, drive-unit
23. Automatic fuse
24. Expansion tank

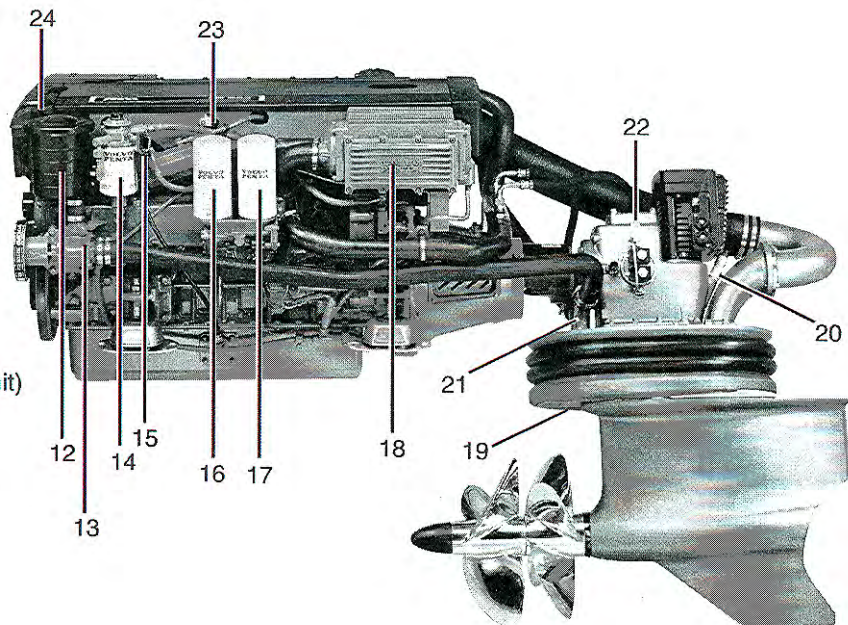



Cosmetic Care & Maintenance

Volvo IPS- Draining/Bleeding The Pre-Filter

There is a diesel pre-filter located in the bilge. It affords additional protection to catch debris such as dirt and water in the fuel. There is a fuel system shut off valve located at the inlet side of the pre-filter.

To bleed the filter do the following:

1. Turn off the fuel valve at the inlet side of the filter.
2. Use a suitable container under the fuel filter.
2. Open the vent screw. Drain off any water by opening the plug at the bottom of the filter.
3. Once drained, close the bottom plug.
4. Unscrew the hand pump. It will pop up.
5. Prime the hand pump. Air bubbles and fuel will purge out of the vent plug. Once the air is completely out of the system close the vent plug. Pump the hand pump a few more times and push it down. Screw it tight in a clockwise direction.

NOTICE

TO PREVENT POSSIBLE DAMAGE TO THE ENVIRONMENT ALWAYS DISPOSE OF USED DIESEL IN A FRIENDLY MANNER.

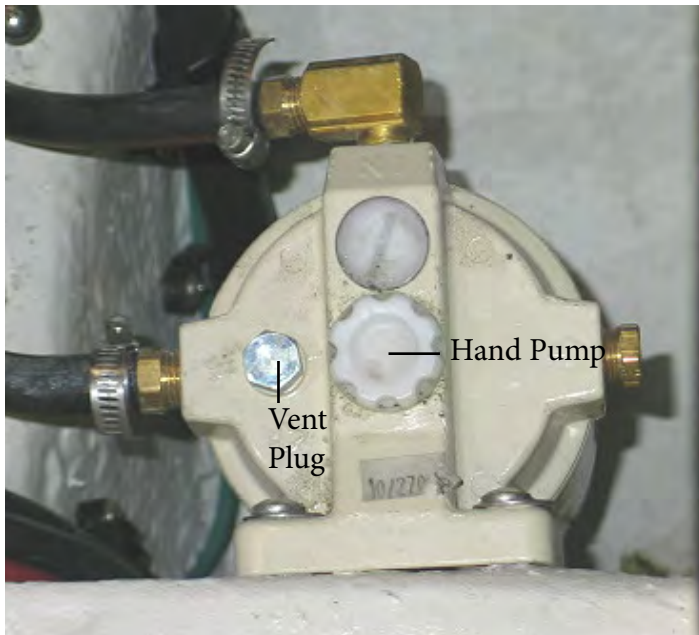



Volvo IPS- Engine Circuit Breakers

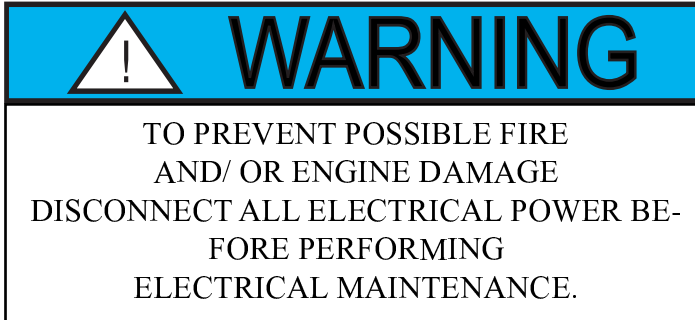

There are circuit breakers on the engine to protect the engine and drive unit wiring circuits. The circuit breakers will shut the power down if an overload occurs.

Symptoms of a circuit breaker problem would be not being able to start the engine or instrumentation not functioning while running the engine or the EVC system failing.

It is important to find the cause of the overload before the circuit breaker is reset. The circuit breaker can be reset by pushing in on it.

Number 1 is the stern drive breaker location and number 2 is the engine breaker location.

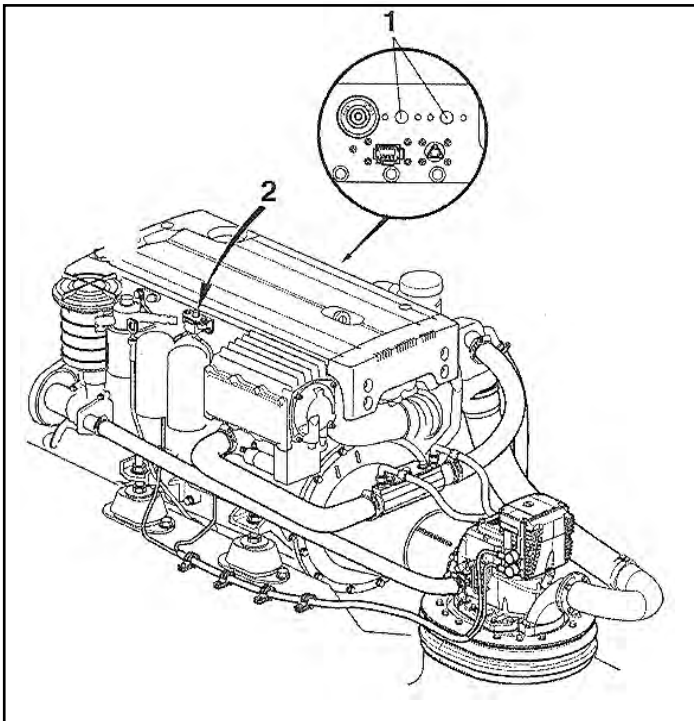



Cosmetic Care & Maintenance

Volvo IPS Propellers- Removing

WARNING

AVOID BODILY INJURY.
REMOVE IGNITION KEY(S)
FROM SWITCH(ES)
BEFORE PERFORMING PROPELLER
MAINTENANCE.

Propellers are important for the vessel to run at peak performance levels and to save fuel. Damaged propellers should be changed immediately.. Carry an extra set of propellers on board since it may be difficult to find the same diameter and pitch replacements in the field.

1. Remove the spinner using the special allen type tool (1) and ratchet or purchase a long allen wrench at a box store.
2. Remove the locking ring with the same special tool combination by unscrewing the four socket cap screws (2). Remove the nut (B) and locking ring (3). Remove the forward propeller from the propeller shaft.
3. Release the locking ring for the aft propeller with the special tool by unscrewing the four socket cap screws (4). Remove nut (C) and locking ring (5). Remove the aft propeller from the propeller shaft.
4. Wipe the propeller shafts with a clean, dry cloth.

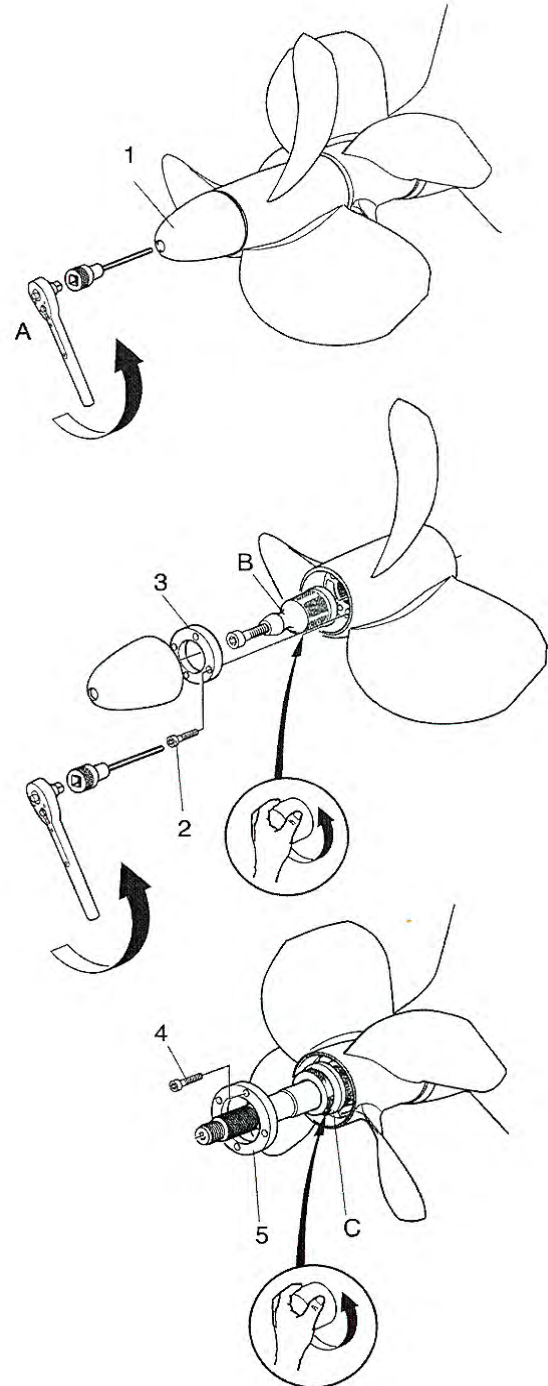



Volvo IPS Propellers- Installing



WARNING

AVOID BODILY INJURY!
ALWAYS REMOVE KEYS FROM
IGNITION SWITCHES BEFORE
BEGINNING PROPELLER MAINTENANCE.

Reassembly of the dual propeller unit requires that the propeller shaft be clean to start and the proper lubricants be applied to the unit.

1. Apply a water-resistant grease such as Volvo # 828250 to the propeller shaft splines.
2. Install the aft propeller. Screw on the aft nut (C) and hand tighten until it reaches the end of its travel. Install the locking ring (5). Tighten the locking ring with the special tool and the four socket cap screws (4). Torque from 17.5 to 20.5 ft. lbs.
3. Install the forward propeller on the propeller shaft. Screw on nut (A) by hand and install locking ring (3). Tighten the locking ring with the special tool and the four socket cap screws. Torque from 17.5 to 20.5 ft. lbs.

NOTICE

TIGHTEN SCREW (D) UNTIL IT BOTTOMS OUT
OR IT WILL NOT BE POSSIBLE TO CHANGE
THE PROPELLER WITHOUT DAMAGING
THE SPINNER.

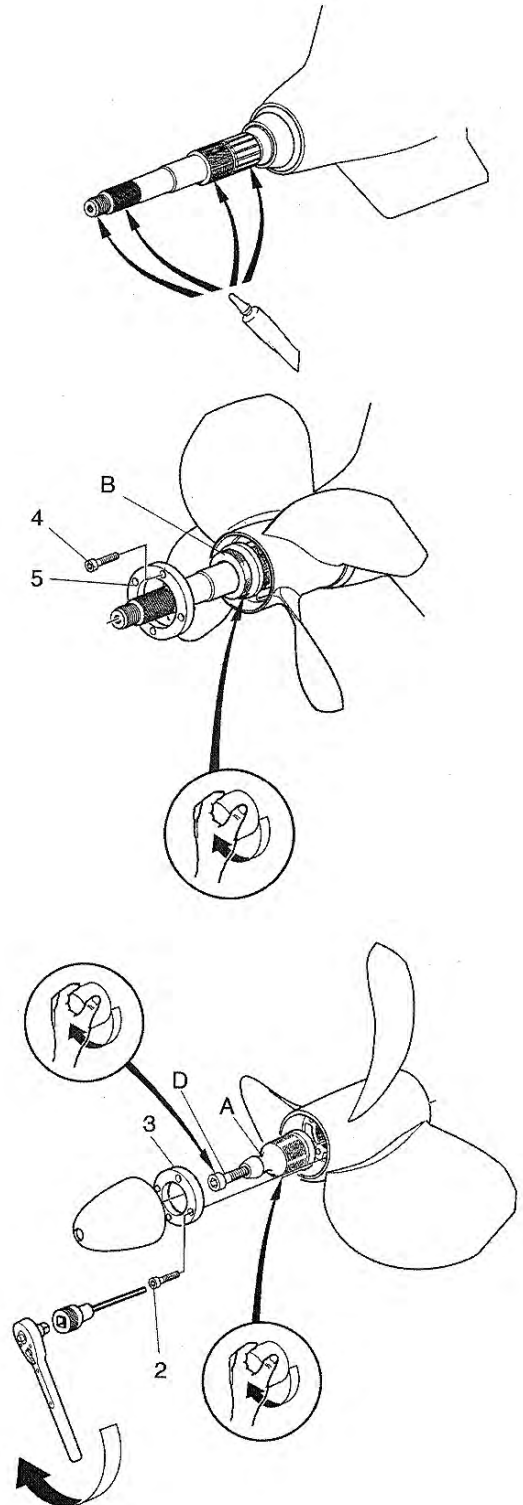



Cosmetic Care & Maintenance

Typical IPS Propeller Specifications

Following are the propeller specifications for yachts using the following IPS engines:

Yacht Model	Volvo Engine Model	Propeller Type
42 GRANDE	IPS 500	T3
COUPE	IPS 600	T3
42 FLY	IPS 500	T4
	IPS 600	T4

Note: All propellers are Nibral Type Material



WINDLASS



The typical windlass needs periodic maintenance to keep it in top running condition. Every 6 months the manufacturer recommends that the unit be disassembled and all the above deck parts be washed down with fresh water. Lightly oil (SAE 10) the seal, shaft, cone clutch and spline. Ensure that the

base, below the gipsy, is cleaned well and the sealing ring is checked. Grease the threads on the chain pipe cover and stripper screws before re-assembly.

The bearing is self lubricating and should not require servicing.

Below the deck check regularly the condition of the motor/gear box and terminals and re-apply grease when necessary. The motor/gear box is two part epoxy painted to protect it against corrosion as it is constructed of steel and lives in the harshest environment on your craft. If corrosion on the motor is evident, clean and repaint with marine grade oil based enamel paint.

Note: Refer to the windlass operator's manual for additional and more detailed maintenance information.



WARNING

TO PREVENT BODILY INJURY
REMOVE THE CHAIN FROM WINDLASS
BEFORE PERFORMING MAINTENANCE.



Flybridge Overview



INTRODUCTION

This chapter is dedicated to the “Fly” version of the Regal 42 footer. Most other parts of the vessel are identical to the Grande Coupe. This chapter will add some feature and system information unique to the Fly version.

Note that features, components and systems shown may be optional and not installed on your vessel. As always, check with your closest Regal yacht dealer regarding any aftermarket options. Regal retains the right to change features, components and systems along with their availability at any time.



FLY DASH FEATURES-TYPICAL

Note that select components may be optional and may not be installed on your vessel.



AUTO FIRE EXT. SYSTEM GAUGE

BRIDGE LTS. ACCESSORY PLUG

ENGINE START PANEL

TRIM TABS

ADJUSTABLE HELM SEAT

HIGH WATER ALARM

VOLVO JOYSTICK

SWITCH PANEL

GARMIN 16" PLOTTER

GARMIN VHF RADIO

VOLVO CONTROL



Flybridge Overview

TYPICAL BRIDGE LAYOUT



The photo above displays a typical bridge layout. Note the electronics mast which may feature closed array radar along with satellite television domes. Also, a VHF antenna is found here.

A fly bridge bimini top provides shade and rain protection. Be sure to read and understand the warning regarding bridge persons capacity shown in pounds and kilograms. Do not exceed these limits.

Also, when the bridge is occupied keep the entry hatch closed and latched. If there is a chain at the bridge rail keep the chain latched when vessel is in motion (see warning label on next page).

	WARNING
DO NOT EXCEED FLY BRIDGE PERSONS CAPACITY 661 LBS./ 300 KG'S	

	WARNING
KEEP BRIDGE ENTRY HATCH CLOSED & LATCHED WITH PASSENGERS ON BRIDGE.	



The vessel may feature a drawer style bridge refrigerator which is installed behind the helm seat.

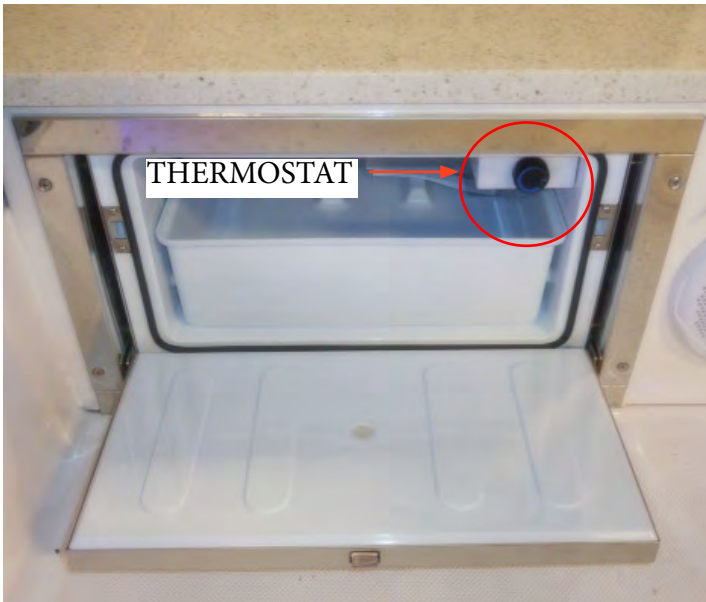

It fits under the bench seat. It features a pull-out tray to for easy access. At the upper right of the unit notice the thermostat control. Turn the knob clockwise to make the temperature cooler or counterclockwise to make temperature warmer.

TYPICAL BRIDGE DRAIN

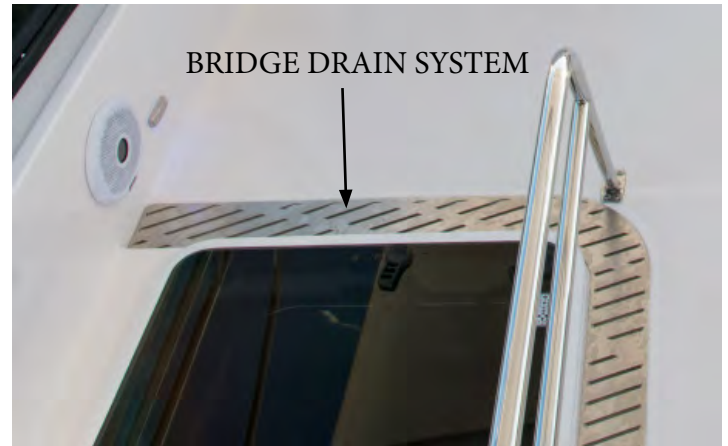

The bridge drain system evacuates runoff bridge water and sends it overboard via a hull side fitting. The stainless steel cover can be removed as needed to clean any debris in the drain holes or the drain raceway.

Notwithstanding, there is a similar cockpit drain system just aft of the salon aft enclosure area. Remove cover and clean periodically as needed.



Flybridge Overview

TYPICAL BRIDGE SEATING OPERATION



The bridge helm seat is adjustable fore and aft through a lever rod component located under the front of the seat. Simply push the rod to the right and while holding it in position push the seat back to the desired location and then release the rod. it will lock the seat in the nearest track detent.



The bridge passenger seat is adjustable fore and aft through an adjustment rod located at the side of the seat. Simply pull the knob and while holding it in position push the seat to the desired location and then release the rod. it will lock the seat in the nearest track detent.



Note the position of the seat hinge. To travel from the upright to the lay down position pull up on the seat to engage the seat in the lay down detent section of the hinge.

Also, there is a center detent for a tilted seat position.



TYPICAL BRIDGE STAIRWAY



The bridge entry way stairway features wide treads and a handrail system to provide safe access to and from the bridge. The teak steps can be maintained by periodically using teak reconditioning products. Be sure to wipe treads off sufficiently to remove any residue .Use a stainless steel polish as needed to retain the corrosion properties of the hand rails, etc.



Flybridge Overview

FLY BRIDGE BIMINI TOP

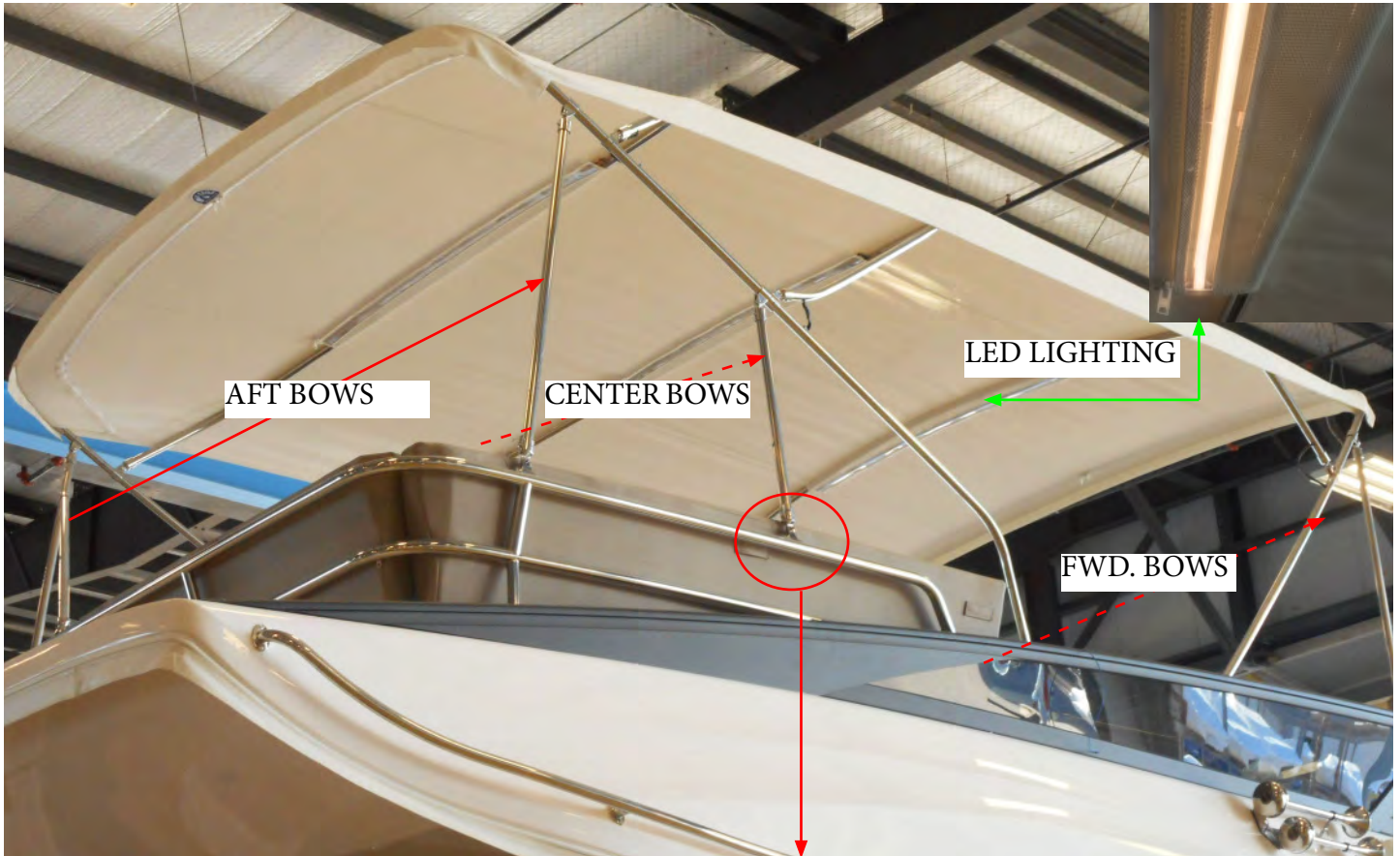

The bridge features a bimini top which affords shade from the sun and protection from the elements. It is a light, UV protected marine fabric. The top assembly is furnished with a complete set of stainless steel bows for durability. The top utilizes 3 sets of bows to assemble or disassemble the cover.

To assemble the cover pull the assembly toward the bow and secure the forward bows. Now pull down as needed on the aft end of the cover and secure the aft bows. Finally, connect the shorter center bows. Check to see that all hardware is fastened securely.

To disassemble the cover disconnect the front bows. Next, disconnect the center bows and finally the aft bows. Lower the assemble toward the aft floor to store in place.

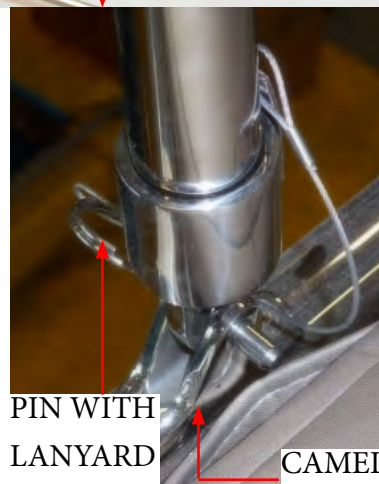

When securing the bimini bows push down and align the hole on the bow end with the camel hole and push the pin through the camel as far outboard as possible. This will latch the bow in place.

Note that there is a LED lighting strip inside each top bow section of the top. The upper helm accessory switch activates the light bars.



Troubleshooting

DIAGNOSTIC CHARTS

The following diagnostic charts will assist you in identifying minor electrical, electronic, fuel, and mechanical problems. Some of the items listed require technical training and tools. Additional up-to-date information is available in the various operation manuals as select items and their troubleshooting techniques may change since the printing of this manual and/or are too numerous to cover in this manual such as electronics components.

Contact your closest Regal dealer, marine professional or internet for further information.

Many times the root cause of a problem can be found using a step by step process of elimination.



WARNING

AVOID BODILY INJURY AND DEATH!
BEFORE PERFORMING ANY MAINTENANCE
WORK TURN OFF THE BATTERY SWITCH AND
REMOVE THE KEYS
FROM THE IGNITION SWITCH.



CAUTION

TO AVOID BODILY INJURY!
USE ONLY APPROVED MARINE
REPLACEMENT PARTS.



CAUTION

TO AVOID BODILY INJURY!
SOME EQUIPMENT CONTAINS HIGH
VOLTAGE. USE CAUTION WHEN SERVICING
ELECTRICAL COMPONENTS.



BOTTOM PAINT



Factory installed antifouling paint is a top-of-the-line product but does need periodic touching up. No paint can be effective under all conditions of exposure.

Man made pollution and natural occurrences can adversely affect antifouling paint performance. Extreme hot and cold water temperatures, silt, dirt, oil, brackish water and even electrolysis can diminish the effects of antifouling paint. Therefore, the vessel bottom needs to be checked periodically to make sure it is clean and no growth is occurring. Lightly scrub the bottom with a soft brush to remove anything from the antifouling surface. Scrubbing is particularly important with vessels that are idle for extended periods of time.

The bottom coating is most effective when the boat is being used on a continuous basis.

On select yachts maintain a 1 1/2" clearance from all anodes, drive units and other underwater gear. Never paint over anodes as they will cease to work properly.

Bottom paint needs to be periodically refurbished. Contact your Regal yacht dealer or a marine professional for additional information.



ELECTRICAL DIAGNOSTICS (AC)

PROBLEM	POSSIBLE CAUSE	POSSIBLE FIX
No AC power	Main shore power breakers tripped or in "off" position	Energize shore power inlet breakers
	Dock power in "off" position	Activate dockside power
	Shore power cord not connected	Plug in shore power cord; twist to lock
	Faulty connection	Repair as needed
	Earlier yachts-Triple breaker tripped at output of isolation transformer	Repair as needed. Reset breakers
	Later yachts-ELCI breaker tripped	Repair as needed. Reset breaker.
Nuisance Tripping- Main ELCI	Component causing excessive draw	Repair/Replace part. Reset ELCI
No power to AC outlets and/or equipment	Main AC ship's panel breakers tripped or in "off" position	Reset or activate main breakers
	Shore power cord not connected	Plug in shore power cord
	GFCI tripped	Find cause of trip. Reset GFIC
Main ship's breaker continues to trip	Faulty main breaker	Contact yacht authorized dealer
Inadequate AC power with genset running	Electrical demand greater than electrical output	Turn off appropriate equipment breakers to lessen load



ELECTRICAL DIAGNOSTICS (DC)

PROBLEM	POSSIBLE CAUSE	POSSIBLE FIX
No DC (12 volt) power	Battery switch in "off" position	Turn selector switch to "on" position,
	Weak or dead battery	Charge or replace battery
Battery not charging (engine running)	Loose belt	Tighten belt
	Faulty alternator	Repair/replace alternator
	Faulty volt meter	Replace volt meter
Battery will not hold charge	Faulty or old battery	Replace battery; use exact replacement
12 volt equipment not working	Equipment switch in "off" position	Switch to "on" position
	Circuit breaker/fuse blown	Reset breaker. Replace fuse.
	Weak or dead battery	Replace battery
	Corroded connection	Eliminate corrosion
	Loose wire	Tighten connection
	Internal equipment short	Replace equipment component



ELECTRONICS- GENERAL

The Garmin electronic packages installed on present yachts are very system specific when troubleshooting. Each package is very unique and we could not cover all the systems here. Therefore, refer to the vendor supplied operator's manual for specific troubleshooting information related to an individual electronic component.

In addition, helpful information is readily available on the internet at each vendor site for the retail customer. Information can be downloaded as needed with additional on-line contact and tech services available. Also, contact your closest Regal yacht dealer where you will find factory trained professionals to assist you in solving more technical electronic component issues.



FRESH WATER DIAGNOSTIC CHART

PROBLEM	POSSIBLE CAUSE	POSSIBLE FIX
Air in water system	Water tank empty	Fill water tank. With pump "on" bleed air from lines until water flows without air.
Fresh water pump cycles on and off	Water system leak	Locate & repair water leak.
No water at sink faucet	Breaker blown	Reset breaker
	Water tank empty	Refill water tank
	Switch turned off	Turn switch to "on" position
	Blocked water filter; pinched line	Clear obstruction or straighten line; clean water filter
	Manifold valve turned off	Turn on manifold valve
	Loose or disconnected wire	Check wire connections
Low water pressure	Defective fresh water pump	Replace water pump
Weak pressure at transom shower	Line pinched	Find/Repair pinched line
Water to pump. No output.	Faulty fresh water pump/pressure switch	Replace fresh water pump or pressure switch
Fresh water pump continues to cycle	Defective pump pressure switch	Replace pressure switch



PERFORMANCE DIAGNOSTICS

PROBLEM	POSSIBLE CAUSE	POSSIBLE FIX
Excessive vibration	Material obstructing propeller	Reverse engines to remove material
	Bent drive propeller shaft	Call authorized Regal/Volvo dealer
	Bent propeller blade	Repair/replace propeller
	Noisy drive bearing	Repair drive unit
	Damaged drive casting	Replace damaged casting
Poor performance	Trim incorrect	Adjust trim
	Unbalanced load	Adjust load
	Engine problem	Call authorized Regal/Volvo dealer
Engine speed/rpm is low	Growth on hull	Hoist vessel; clean bottom
	Poor quality fuel	Call authorized Regal/Volvo dealer
	Insufficient air supply to engine	Check air filtes, ventilation system
	Accumulation of bilge water	Check for leaks
	Trim tab in "up" position	Check trim tab functions/pump fluid levels



REFRIGERATOR DIAGNOSTIC CHART		
PROBLEM	POSSIBLE CAUSE	POSSIBLE FIX
Refrigerator not cold	Compressor will not start	Turn breaker on at the main ship's service panel
	Thermostat set too high or on/off switch is in the off position	Reset thermostat or activate on-off switch
	Compressor starts but does not cool fridge	Contact repair professional
	Door latch not closing or door seal not seated	Adjust latch or replace seal
	Condenser coils dirty	Remove fridge/clean coils with brush or vacuum
Not running on DC	Check for defective thermostat or converter, low battery	Relace thermostat, converter or battery
Not running on AC	Inadequate input voltage	Make sure proper voltage exists on ship's main AC panel.



SHORE CABLE SYSTEM

COMPLAINT	PROBABLE CAUSE	RECOMMENDED ACTION
Non-functional (either no power or unit has power and does not respond)	<ul style="list-style-type: none"> <input type="radio"/> Tripped breaker <input type="radio"/> Power wire incorrectly connected to relay assembly <input type="radio"/> Defective motor <input type="radio"/> Defective relay box 	<ul style="list-style-type: none"> <input type="radio"/> Reset breaker <input type="radio"/> Replace relay assembly <input type="radio"/> With power switch on and voltage across motor wires — if no response, replace motor
Pays out cable only	<ul style="list-style-type: none"> <input type="radio"/> In-Limit switch circuit open <input type="radio"/> Power inputs reversed <input type="radio"/> Defective relay or diode <input type="radio"/> Bad power switch 	<ul style="list-style-type: none"> <input type="radio"/> Check in-limit switch <input type="radio"/> Check polarity on DC input wires <input type="radio"/> Replace relay assembly <input type="radio"/> Check power switch
Retracts cable only	<ul style="list-style-type: none"> <input type="radio"/> Out-Limit switch circuit open <input type="radio"/> Defective relay <input type="radio"/> Bad power switch 	<ul style="list-style-type: none"> <input type="radio"/> Check out-limit switch <input type="radio"/> Replace relay assembly <input type="radio"/> Check power switch
Tripped DC breaker	<ul style="list-style-type: none"> <input type="radio"/> Main pulley too tight <input type="radio"/> Cable jammed and kinking <input type="radio"/> Defective motor 	<ul style="list-style-type: none"> <input type="radio"/> Adjust pulley <input type="radio"/> Check for adequate storage space and/or cable for undue kinking — see Cable Adjustment (pg. ?) <input type="radio"/> Disconnect motor wires from relay box. Apply power directly to motor wires; motor should run one direction or other — no response from motor; replace motor



SIRIUS MARINE WEATHER

LED STATUS

The LED at the connector panel provides valuable troubleshooting information on the status of your weather system.

The LED blinks green while the system is operating normally. If the unit detects a problem, the LED blinks amber to indicate a warning or red to indicate an error. The pattern of the LED blink is a code representing the nature of the problem. For multiple warnings/errors the codes are given in sequence with a 1.5 second pause between the indications.

It is normal during the first minute of initial power that the SR100 status LED shows no activity and remains off. During the second minute the status LED will start to flash the amber or red fault strings. Typically, during normal operation, a flashing green LED will occur within 90 seconds of initial power. If there is no LED indication of any sort displayed after 90 seconds you should check the circuit breaker.

A blinking red LED indicates an internal fault condition and a marine electronics technician should be contacted.

The following table shows the LED status codes and their meanings:

LED COLOR	LED PATTERN	DESCRIPTION
GREEN	BLINKING	NORMAL OPERATION
AMBER	1 SEC ON 1 SEC OFF	ANTENNA UNHOOKED
AMBER	1 SEC ON 1 SEC OFF 1SEC ON 1SEC OFF	SEATALK CABLE UNHOOKED
RED	BLINKING	I N T E R N A L FAULT



TELEVISION DIAGNOSTIC CHART

PROBLEM	POSSIBLE CAUSE	POSSIBLE FIX
Screen is black. Power indicator is off.	TV breaker not activated	Activate TV breaker on ship's main service AC panel.
	TV and/or DVD not turned on.	Activate TV or DVD player.
TV signal weak.	TV antenna breaker not activated or wrong antenna breaker in use.	Activate TV antenna breaker. Check antenna switch for proper signal button.
Image too light or dark.	Brightness or contrast improperly adjusted.	Readjust brightness or contrast to owner's manual specifications.
Horizontal bars appear to flicker, jitter, or shimmer on the image.	Fine function not adjusted properly.	Adjust fine function to owner's manual specifications.
Vertical bars appear to flicker, jitter or shimmer on the image.	Coarse function not adjusted properly.	Adjust coarse function. Then adjust fine function.
Screen is blank and power indicator light is steady amber or blinks every 1/2 or 1 second.	Power management system being used.	See power saver in owner's manual.
Image not centered on screen	Horizontal or vertical adjustments off.	Readjust horizontal or vertical controls.



TOILET (TECHMA) DIAGNOSTIC CHART

PROBLEM	CAUSE	ACTION/SOLUTION
Toilet does not flush or flushing performance is poor	Waste tank is full (tank indicator light on wall switch is RED) Clog at pump inlet Solid object in macerator Low voltage	Empty waste tank before continuing to use toilet. Override full tank lock-out may cause waste tank to overflow Clear clog Call Tecma at (800-521-3032) Check for no more than 10% decrease in voltage when macerator is running. If voltage decreases more than this there may be wiring problem
Water does not enter bowl during flush or water add cycle	Water supply line kinked or not connected No power to water pump Water supply has been turned off Electronic control problem	Check that supply line is properly connected to fresh water supply. Check for kinks in water supply line Check that circuit breaker has not tripped, check all pump electrical connectors Check water supply valve at manifold Call Tecma at (800-521-3032)
Water level in bowl has changed after flush	Flush refill mode has been changed	Reprogram flush refill mode; see Tecma owner's manual
Water continues dripping briefly into bowl after flush cycle is complete	Toilet is installed below water line with vacuum breaker in water supply line	Normal operation; if only a small amount drips from the nozzle
Bowl drains dry after flush	Water is siphoning out of the bowl	Discharge hose from macerator pump bent. Straighten hose
Wall switch does not appear to light up or does not stay lit	No power to toilet Wall switch not properly connected to toilet Wall switch has entered sleep mode	Check that breaker is not tripped. Check electrical connectors are mated Ensure wall switch electrical connector is fully engaged at controller Wall switch enters sleep mode after 8 hours of continuous inactivity but remains functional. No action needed
	Wall switch electronics problem	Call Tecma at (800-521-3032)
Toilet is inoperative and there is no lighting in the wall switch	No power to toilet	Check that breaker is not tripped. Ensure all electrical connectors are mated. Call Tecma.



VACUUM CLEANING SYSTEM

If The Motor Stops Suddenly:

1. The most common cause is a clogged hose. Try to unclog the hose with a long stick or by shaking the hose until the clogged debris clears.
2. The bag is overfilled and fine dust has clogged the bag.
3. The vacuum cleaning tools are clogged.
4. The motor (exhaust) filter is dirty and should be cleaned or replaced.
5. Ensure that the area around the main unit is free of clutter to provide proper amount air to the unit. This will help prevent the unit from shutting down.



TYPICAL WINDLASS

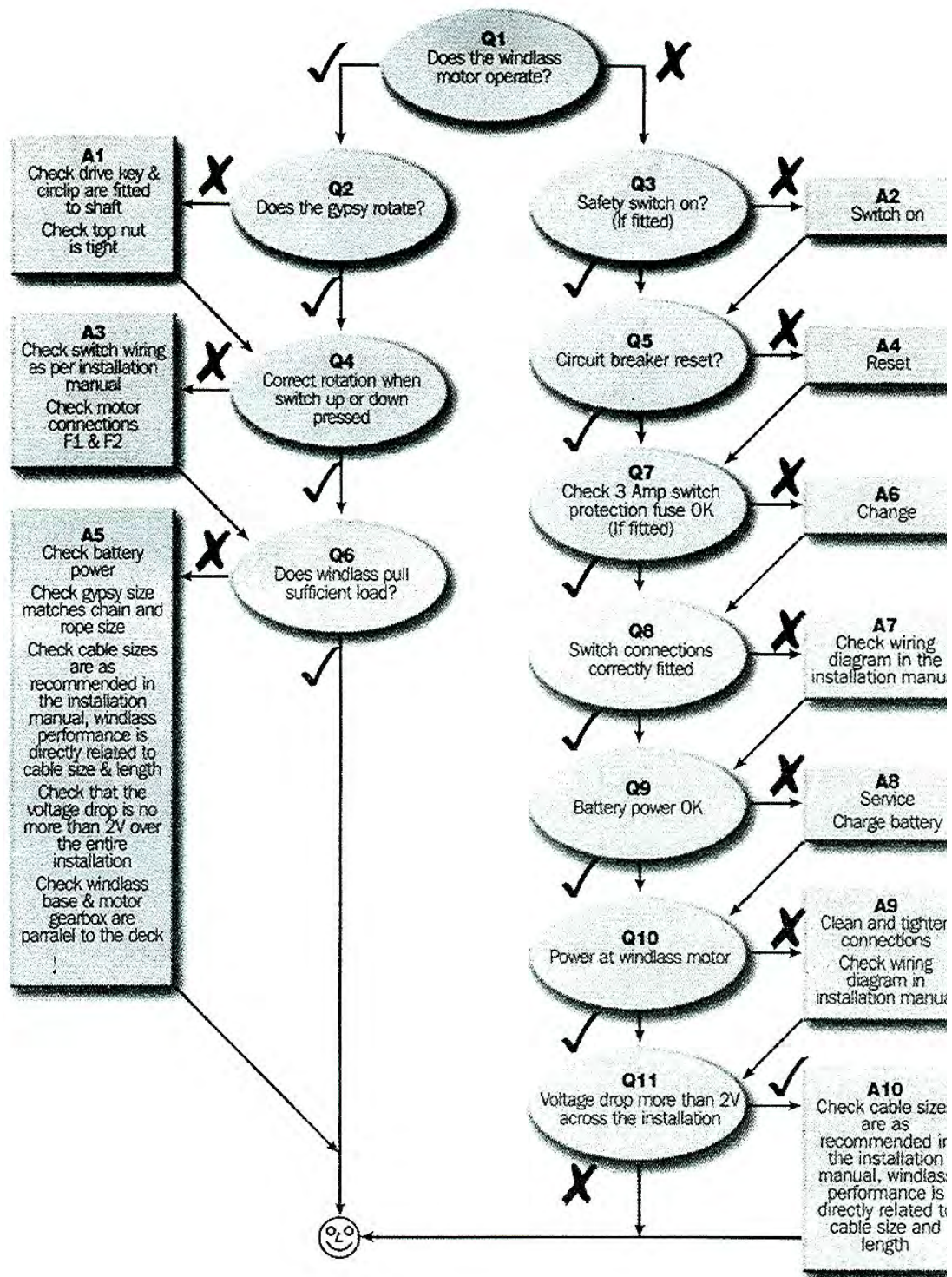



Storage & Winterization



INTRODUCTION

Storage procedures are outlined in this chapter. These are general guidelines to follow in colder climates. Be sure to familiarize yourself with all relevant information in the owner's packet. Special winterization procedures are necessary for the boat equipment and systems. Use the enclosed checklists to help you identify areas of concern and maintenance. These lists cover land stored boats either inside or outside.

It is best to contact your closest Regal yacht dealer or marine professional for winterization information. They possess the advanced service know how needed to tackle the more complex yacht systems.



WARNING

EXPLOSION, FIRE & POLLUTION HAZARD!
DO NOT FILL FUEL TANK
TO RATED CAPACITY.
LEAVE ROOM FOR EXPANSION.

NOTICE

YOUR WARRANTY DOES NOT COVER
DAMAGE TO YOUR BOAT IF IT IS NOT
PROPERLY STORED AND WINTERIZED.
CHECK WITH A REGAL DEALER OR
MARINE PROFESSIONAL ABOUT
WINTERIZATION PROCEDURES.

NOTICE

REMOVE ALL BATTERIES
WHEN VESSEL IS STORED
FOR EXTENDED PERIODS



DECOMMISSIONING CHECKLIST

BOAT

- Check hull bottom for any fiberglass damage. Repair as needed.
- Apply a coat of wax to hull and deck surfaces.
- Pour a pint of 50/50 antifreeze into bilge pump.
- Remove batteries. Trickle charge over extended periods. Do not set batteries on cement. Use wood blocks.
- Remove all loose gear from boat such as life jackets, etc. Inspect and store in cool, dry environment.
- Remove drain plug. Clean drain plug hole of debris as needed. Enclose drain plug in plastic bag and tie to steering wheel.
- Drain the waste system per instructions in this chapter. Make sure bow is higher than stern to permit proper drainage.
- Clean all upholstery and store so it breathes.
- Conduct a visual inspection to ensure boat is balanced properly. Bow should sit slightly up especially if outside.
- Cover boat with tarp. Tie down for wind protection if outside. Prop tarp up as needed to provide proper ventilation. Be sure not to cover up the fuel vents.
- Drain the fresh water system per instructions in this chapter.
- Send in appropriate equipment for calibration such as the automatic fire extinguisher canister or CO detectors.
- Never use blocking to support the hull bottom as structural hull damage may occur to the vessel.

ENGINES

The propulsion systems on your yacht are complex in scope. In colder climates, it is recommended that your Regal yacht dealer winterize your boat's engines. Regal dealers have undergone extensive factory training covering the Regal yacht product line. Also, the dealer is equipped with the parts and tools to perform a care free winterization procedure.

- Run engine. Pour a fuel stabilizer/conditioner in the fuel tank. Allow time for it to circulate through the fuel system. Top off fuel tanks to help prevent condensation.
- Change all engine fluids as referenced in the engine manufacturer's owners manual.
- Drain cooling and exhaust system or have a marine professional "pickle" the engine with antifreeze and rust preventative.
- Spray all exterior parts with a rust preventative.



Storage & Winterization

GENERAL NOTES ON ANTIFREEZE

Engine cooling fluids must be replaced with a marine antifreeze solution; mix antifreeze according to directions for the lowest expected temperature. The above method is much more reliable than just draining the engines and manifolds because sometimes pockets of water can form which can freeze in cold temperatures and cause engine damage. Draining the system fosters rust in engine parts. Historically, antifreeze was originally made with methanol. It was because of its chemical nature to escape into the atmosphere and a high corrosion factor on engine metals that it was replaced.

Today, ethylene glycol is used in auto and marine engine applications because of its positive thermal properties. On the downside ethylene glycol contains silicate rust inhibitors that can clog up marine heat exchanger surfaces. This is why it is so important to follow the engine manufacturer maintenance schedules which include changing the antifreeze periodically. In addition, the unpleasant odor of antifreeze is caused by tolytriazole which also contributes to it being environmentally hazardous. Notwithstanding, ethylene glycol is poisonous to the human body along with animals. Therefore, it cannot be used in potable marine water systems.

Propylene glycol is considerably less toxic and retail products are labeled as “non-toxic antifreeze”. It is the product of choice for marine water and waste tanks in freezing climates. It is available at marinas, RV dealerships, and retail marine outlets.

IPS DRIVE UNITS

Since the IPS drive units are located under the vessel it makes good sense to use a Regal yacht dealer to ensure the units are winterized and have their seasonal maintenance. The yacht dealer can check all drive related systems along with the installed propellers. This is a great time to have the propellers checked for balance and knicks.

Also, when the the propellers and hardware are off the propeller shaft and seals can be checked for vacuum and pressure along with touching up the drive unit.

Refer to your Volvo IPS operator’s manual for a specific drive information and maintenance schedules.

NOTICE

USE A SPECIAL NON-TOXIC ANTIFREEZE
IN THE FRESH WATER & WASTE SYSTEM
WHICH IS AVAILABLE AT RV AND
MARINE DEALERS.
DO NOT USE AN AUTOMOTIVE
TYPE ANTIFREEZE.
IT CAN BE HIGHLY
POISONOUS AND CORROSIVE.



AIR CONDITIONING:

There are several methods of winterization; some work better than others. The various methods employed using a 50/50 biodegradable antifreeze/water solution are:

1. Pumping of antifreeze solution into the overboard thru-hull fitting, and discharging through the intake thru-hull fitting.
2. Use of the seawater pump to move antifreeze solution through the system and discharging through the overboard thru-hull fitting. Close the seacock, remove the hose for the strainer outlet, raise the hose above the AC pump (to prevent loss of prime) and pour in antifreeze solution. Pump solution through system. The strainer and hose to seacock will also need to be drained.
3. Use of pressurized air to force water from the intake through the overboard discharge.

Note: Any method that causes the antifreeze solution to flow downward is the method of choice. By this means, the antifreeze solution will displace any water trapped and eliminate the possibility of freezing in hidden areas. In addition, since the seawater pump utilizes a magnetically driven impeller, the impeller should be removed from the wet end assembly, wiped with an alcohol solution, and stored in a warm, dry area until commissioning takes place.

BATTERIES:

Remove the batteries and check the electrolyte level. Store in a cool, dry place. Add distilled water as necessary to top off the battery.

Monthly recharging or continuous trickle charging should be done to insure the battery life during storage. Do not store a battery on cement as it may discharge.

FUEL TANK

Fill the fuel tank to minimize condensation but do not overfill. Leave enough space for fuel to expand and add a fuel stabilizer to diesel prior to storage following the manufacturer's recommended procedures.

NOTICE

FOR THE PURPOSE OF PROTECTING
THE ENVIRONMENT,
DISPOSE OF ANY CONTAMINATED
ACID SOLUTIONS
IN ACCORDANCE WITH
FEDERAL, STATE AND/OR LOCAL
REGULATIONS.



Storage & Winterization

TELEVISION:

The television manufacturer recommends that the unit be removed from the vessel in freezing climates. To remove the flat screen do the following:

1. Pull out the power plug from the rear of the television.
2. Unscrew the antenna cable.
3. While someone holds the flat screen, remove the screws that hold the television to the bracket.
4. Do not touch the flat screen or push in on it while trying to remove the unit as component damage may result.
5. Remove the television and store at room temperature.





WASTE/TOILET SYSTEM:

1. Pump out waste holding tank, flush the tank with fresh water and pump out again.
2. With **non-toxic** antifreeze in the fresh water tank, operate head until antifreeze flows into bowl of each head. Allow time between flushes for the vacuum to build up.
3. Operate macerator until antifreeze has a steady flow coming from the discharge fitting. Pour non-toxic propylene glycol antifreeze solution in head and flush head as needed to produce enough flow to winterize the macerator.
4. Leave at least 2 gallons of **non-toxic** antifreeze solution in the holding tank during storage.

NOTICE

USE A SPECIAL NON-TOXIC ANTIFREEZE
IN THE FRESH WATER & WASTE SYSTEM
WHICH IS AVAILABLE AT RV AND
MARINE DEALERS.
DO NOT USE AN AUTOMOTIVE
TYPE ANTIFREEZE.
IT CAN BE HIGHLY
POISONOUS AND CORROSIVE.



Storage & Winterization

WATER SYSTEM-FRESH

1. Turn on the fresh water pump switch.
2. Open all faucets including transom shower and allow tank to empty.
3. Drain the water heater; shut off water pump switch.
4. Mix **nontoxic** antifreeze with water in accordance with the manufacturer's recommendations.
5. Pour solution into the fresh water tank.
6. Turn on fresh water pump switch.
7. Open each cold water faucet one by one beginning with the one furthest away from the tank and purge the system until a steady stream flows from the faucet. Then close the faucet.
8. Repeat step 7 for hot water faucets.
9. Shut off water pump switch.
10. Pour a quart of **non-toxic** antifreeze into shower drain. Run the shower pump until a steady stream flows from the discharge fitting.
11. Leave at least 2 gallons of **non-toxic** antifreeze solution in the holding tank during storage.



Glossary & Index

Following is a brief list of nautical terms useful in everyday boating experiences and communications. For more detailed glossaries of nautical terminology we recommend you check your local library, the internet or a marine store for boating books.

GLOSSARY

Abeam: at right angles to the fore and aft line and off the boat

Aboard: on or in the boat

Above: the part of the boat on a bavin vessel which is above the interior of the boat

Aft, After: aft is the boat section toward the stern or back of the boat

Admidships: toward the center of the boat from either side to side or rear to front

Beam: the width of a boat at its widest part

Bilge: the lower interior of the hull of the boat

Bitter end: the end of a line also the end of an anchor line

Bow: the front, or forward part of the boat

Bulkhead: the vertical partition or wall of a boat

Cast off: to let go or release

Chine: the line fore and aft formed by the intersection of the side and bottom of the boat

Chock: deck fitting used to secure or guide anchor or tie lines

Cleat: deck fitting with protruding arms around which lines are secured

Cockpit: the seating space used to accomodate passengers

Cuddy: a small cabin in the fore part of the boat

Deck: the open flooring surface on which crew and passengers walk

Draft: the depth from the waterline of the boat to the lowest part of the boat, which indicates how much water is required to float the boat



Chapter 12

Fathom: a measurement of depth; one fathom equals six feet	PFD: personal flotation device; required for each person aboard
Fender: a cushion hung from the side of a boat to prevent it from rubbing against a dock or against other boats	Port: the left side of the boat when facing forward (an easy way to remember the difference between “port” and “starboard” is that both “port” and “left” have four letters)
Fend off: to push off to avoid sharp contact with dock or other vessel	Shank: the main body of an anchor
Fore: the part of the boat toward the bow or front	Sheer: the curve of the boat’s deck from fore to aft when seen from the side
Freeboard: the height of the top side from the waterline to the deck at its shortest point. (The distance from the sheer or gunwale to the water)	Starboard: the right side of the boat when facing forward
Galley: cooking area	Stern: the aft end of the boat
Gunwale: rail or upper edge of the side of the boat	Stern drive: an inboard/outboard (IO) unit
Hatch: an opening in the deck to provide access below	Stringer: strengthening integral unit fastened from fore to aft inside the hull and fiberglass encapsulated for added strength: much like the skeleton system of our body
Head: toilet	Top off: to fill up a tank
Hull: the part of the hull from the deck down	Transom: the vertical part of the stern.
IPS: inboard propulsion system by Volvo	Trim: the boat’s balance when properly loaded
Keel: the lowest point of a boat	Wake: the path of a boat left astern in the water
Knots: a measurement of speed indicating nautical miles per hour	
Lee: the side opposite that from which the wind is blowing; the side sheltered from the wind	
Leeward: the direction toward which the wind is blowing	



Glossary & Index

A		C	
AC Current	93	Cabinet Care	249
	316	Canvas	313
AC Panel	100		250
Accidents	40	Carbon Monoxide	35
Air Conditioning	194	Carbon Monoxide Detector	38
	266		195
Alcohol Myths & Facts	39		275
Antenna- GPS	210	Cardiopulmonary Resuscitation	189
Anchoring	187	Carpet- Interior	251
		Cockpit Covering- Seagrass	252
		Countertop Surfaces	253
B		D	
Batteries	66	Dealer Responsibilities	16
	270	Decommissioning	330
Battery Charger	73	Diagnostic Charts (Troubleshooting)	314
Battery Management Panel	78	Diesel Fuel Filter	61
Battery Parallel Switch	77	Direct Current (DC)	65
	164	DC Panel	83
	273		316
Battery Switches	67	Distress Signals	29
Battery System Breaker	72	Diver's Flag	42
Bilge-Engine Compartment	170	Docking	186
Bilge Pump	211	Dock Lines	184
	274	Dockside Power (Shorepower)	93
Bottom Paint	212		323
	315	Dockside Water Inlet	120
Breaker Panel	85	Dockside Pump-Out	133
Breast Lines	184	Door (Salon Entry)	276
Bridge Clearance	51	Door (Transom)	214



Chapter 12

E		G	
ELCI	96	GFIC	104
Electrical	64		283
	348	Galvanic Isolator	98
Electronics:	318	Gelcoat Maintenance	255
Auto Pilot	156	General Boating Safety	22
Chartplotter	148	Generator	106
Depth Sounder/Sonar	158		219
Radar	155	Generator Maintenance	280
		Getting Underway	179
Sirius Marine Weather	159	Glossary	336
Sirius Satellite Radio	147	Gray Water System	130
Emergency Steering	176		
Engine	160		
	299	H	
Entertainment System	144	Hatches	197
Environmental Awareness	192	Heater-Hot Water	128
Equipment Operation	193		222
Exhaust	35		284
		High Water Alarm	165
F			224
Fabrics-Interior	254		285
Fenders	183	HIN	11
Fiberglass Maintenance	255	Hull/Deck	259
Fire Extinguishers	26	Hypothermia	190
	217		
	278	I	
Fires	189	Index	336
First Aid	189	Instrumentation/Gauges	166
Flooring	257		258
Float Plan	13		320
Fresh Water System	120	International Distress Signals	29
	319		
Fuel System	55	J	
	279	Joystick	172
		K	
		Knots	186



Glossary & Index

L		R	
Lights/Lighting	31	Range/Stove	205
	199		260
M		Refrigerator	322
Maintaining PFD'S	26	Registration Information	16
Markers-For Slings	225	Relay (VSR)	74
Mayday	30	Remote Control	171
Metal (Stainless Steel)	261	Right-Of-Way	44
Minimum Required Equipment	34	Rules Of The Road	44
Monitor Panel	74		
	230		
N			
Navigation Aids	48		
Navigation Light Rules	31		
Navigation Rules	44		
O			
Oil Change System	226		
Oil Spills	32		
Overboard Discharge Pump	134		
	290		
Overloading	23		
Owner's Packet	10		
Owner Responsibilities	17		
P			
Personal Flotation Devices	24		
Plastics	260		
Plumbing Connectors	288		
Pollution Regulations	32		
Pre-departure Questionnaire	179		
Propellers	177		
Propulsion	175		
Pressure Pump-Fresh Water	123		
	231		



Chapter 12

S		T	
Safety Labels	21	Technical Drawings	347
Seacocks/Strainers	118	Technical Information	342
	125	Television	202
	295		296
Seat- Helm	204		327
Shorepower (See Dockside Power)		Toilet	131
Shower-Transom	125		296
	233		326
Shower Sump Pump	128	Towing	188
	291	Trim Tabs	137
Sound Producing Devices	30	Troubleshooting	314
Specifications/Dimensions	386		
	387	U	
Spotlight	234	Underwater Lighting	246
Spring Line	184	Upholstery	263
Stainless Steel	261		
Stains	262	V	
Stern Line	184	VHF	30
Stereo	147		165
	292		277
Sunpad/Chaise Lounge	213	Vacuum Cleaner System	208
Swim Ladder	244		327
Swim Platform	245	Valves-Fuel/Generator	59
		Ventilation System	58
			162
		Vessel Information Sheet	12
		Visual Distress Signals	27
		Volvo Joystick	172
		W	
		Waste System	129
		Windlass	139
			306
			328
		Winterization	329
		Z	
		Zipper Care	250



Technical



A portion of the technical drawings found in this chapter are actual product drawings from the Regal factory. These drawings should be of special interest in mechanical and electrical troubleshooting. The equipment in the drawings is discussed in the various sections of this manual. Understanding specific systems and related drawings will go a long ways in solving problems. Refer to the vendor owner's manual regarding many of the components found on your vessel.

TECHNICAL INFORMATION

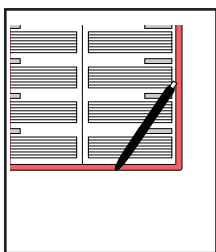

Note that all product specifications, models, standard, optional equipment, systems, along with the technical information is subject to change without notice.

For more information contact your nearest authorized Regal dealer.

For the location of your nearest authorized dealer call 407-851-4360

or you can contact Regal through the internet at : www.regalboats.com. Your Regal dealer has received special factory training on the entire product line and his services should be employed to solve more technical problems.



TYPICAL LABEL LOCATIONS

NOTICE
Retrieval of Windless Chain
 Winch operator may be required to periodically spread chain out within anchor locker

WARNING
 KEEP CHAIN LATCHED
 WHEN VESSEL IS IN MOTION!

WARNING
 DO NOT EXCEED FLY BRIDGE
 PERSONS CAPACITY OF
 661 Lbs./300 Kg's>

SLING

Discharging of waste within the 3 mile U.S. coastal limit is prohibited by federal law. Shut off valve must be secured closed within U.S. Waters.

DISCHARGE OF OIL PROHIBITED
 THE FEDERAL WATER POLLUTION CONTROL ACT PROHIBITS THE DISCHARGE OF OIL OR OILY WASTE INTO OR UPON THE NAVIGABLE WATERS AND CONTIGUOUS ZONE OF THE UNITED STATES IF SUCH DISCHARGE CAUSES A FILM OR SHEEN UPON, OR DISCOLORATION OF THE SURFACE OF THE WATER, OR CAUSES A SLUDGE OR EMULSION BENEATH THE SURFACE OF THE WATER. VIOLATORS ARE SUBJECT TO A PENALTY OF \$5,000

SLING

WARNING
 To minimize shock and fire hazards:
 (1) Turn off the boat's shore connection switch before connecting or disconnecting shore cable.
 (2) Connect shore-power cable at the boat first.
 (3) If polarity warning indicator is activated, immediately disconnect cable.
 (4) Close shore-power inlet cover tightly. DO NOT ALTER SHORE-POWER CABLE CONNECTORS

WARNING
 Carbon monoxide (CO) can cause brain damage or death.
 Engine and generator exhaust contains odorless and colorless carbon monoxide gas.
 Signs of carbon monoxide poisoning include nausea, headache, dizziness, drowsiness, and lack of consciousness.
 Get fresh air if anyone shows signs of carbon monoxide poisoning.
 See Owner's Manual for information regarding carbon monoxide poisoning.

WARNING
 GASOLINE VAPORS CAN EXPLODE BEFORE STARTING ENGINE. OPERATE BLOWER 4 MIN. AND CHECK ENGINE COMPARTMENT FOR GASOLINE LEAKS OR VAPORS. RUN BLOWER BELOW CRUISING SPEED.

WARNING
 TRANSOM DOOR MUST BE CLOSED AND SECURE WHEN ENGINE IS RUNNING

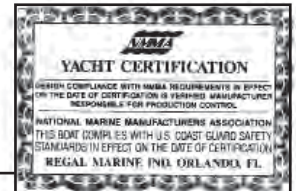

POWER SWITCH AT BOW ANCHOR WINDLASS MUST BE IN OFF POSITION WHEN NOT IN USE.

THE DISCHARGE OF PLASTIC OR GARBAGE MIXED WITH PLASTIC INTO ANY WATERS IS PROHIBITED. THE DISCHARGE OF ALL GARBAGE IS PROHIBITED IN THE NAVIGABLE WATERS OF THE UNITED STATES AND, IN ALL OTHER WATERS, WITHIN THREE NAUTICAL MILES OF THE NEAREST LAND.

THE DISCHARGE OF DUNNAGE, LUMBER, AND PACKING MATERIALS THAT FLOAT IS PROHIBITED WITHIN 25 NAUTICAL MILES FROM THE NEAREST LAND.	OTHER UNGROUND GARBAGE MAY BE DISCHARGED BEYOND 12 NAUTICAL MILES FROM THE NEAREST LAND.	OTHER GARBAGE GROUND TO LESS THAN ONE INCH MAY BE DISCHARGED BEYOND THREE NAUTICAL MILES OF THE NEAREST LAND.
--	--	---

A PERSON WHO VIOLATES THE ABOVE REQUIREMENTS IS LIABLE FOR A CIVIL PENALTY OF UP TO \$25,000, A FINE OF UP TO \$50,000, AND IMPRISONMENT FOR UP TO FIVE YEARS FOR EACH VIOLATION. REGIONAL, STATE, AND LOCAL RESTRICTIONS ON GARBAGE DISCHARGES ALSO MAY APPLY.

WARNING
 Carbon monoxide (CO) can cause brain damage or death.
 Carbon monoxide can be present in the cabin.
 Signs of carbon monoxide poisoning include nausea, headache, dizziness, drowsiness, and lack of consciousness.
 Get fresh air if anyone shows signs of carbon monoxide poisoning.
 Get fresh air if carbon monoxide detector alarm sounds.
 Carbon monoxide detector must be functioning at all times.

WARNING
 LEAKING FUEL IS A FIRE AND EXPLOSION HAZARD. INSPECT SYSTEM REGULARLY. EXAMINE FUEL SYSTEM FOR LEAKS OR CORROSION AT LEAST ANNUALLY.

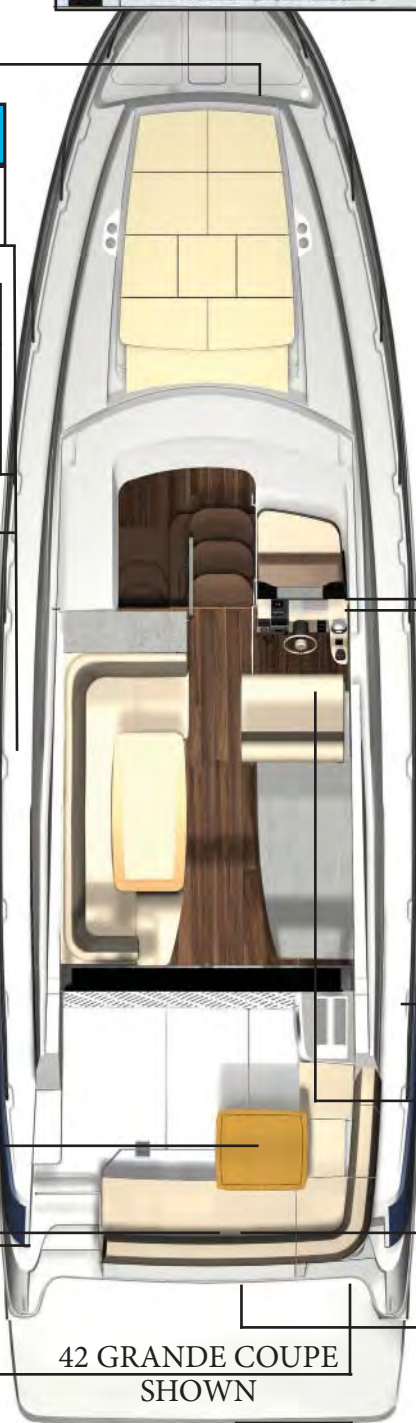

42 GRANDE COUPE
 SHOWN

WARNING!
 MAXIMUM CAPACITY OF SWIM PLATFORM
 1000 POUNDS
 453 KG

WARNING
 Carbon monoxide (CO) can cause brain damage or death.
 Engine and generator exhaust contains odorless and colorless carbon monoxide gas.
 Carbon monoxide will be around the back of the boat when engines or generators are running.
 Move to fresh air, if you feel nausea, headache, dizziness, or drowsiness.

*Note-Drawing Not To Scale
 Labels & Locations Subject To Change

Note: Labels Vary By Model



42 GRANDE COUPE/FLY DECK FEATURES

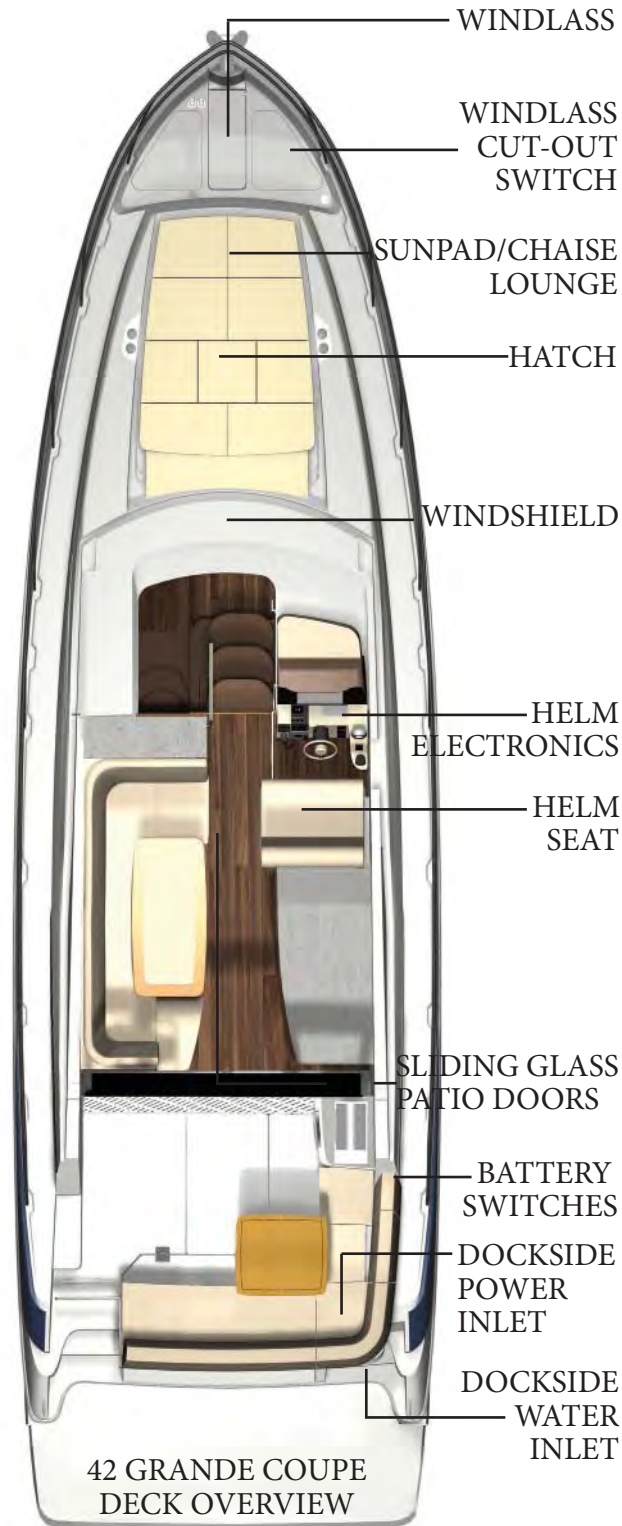

*NOTE: NOT TO SCALE/SELECT FEATURES SHOWN



42 GRANDE COUPE/FLY CABIN FEATURES

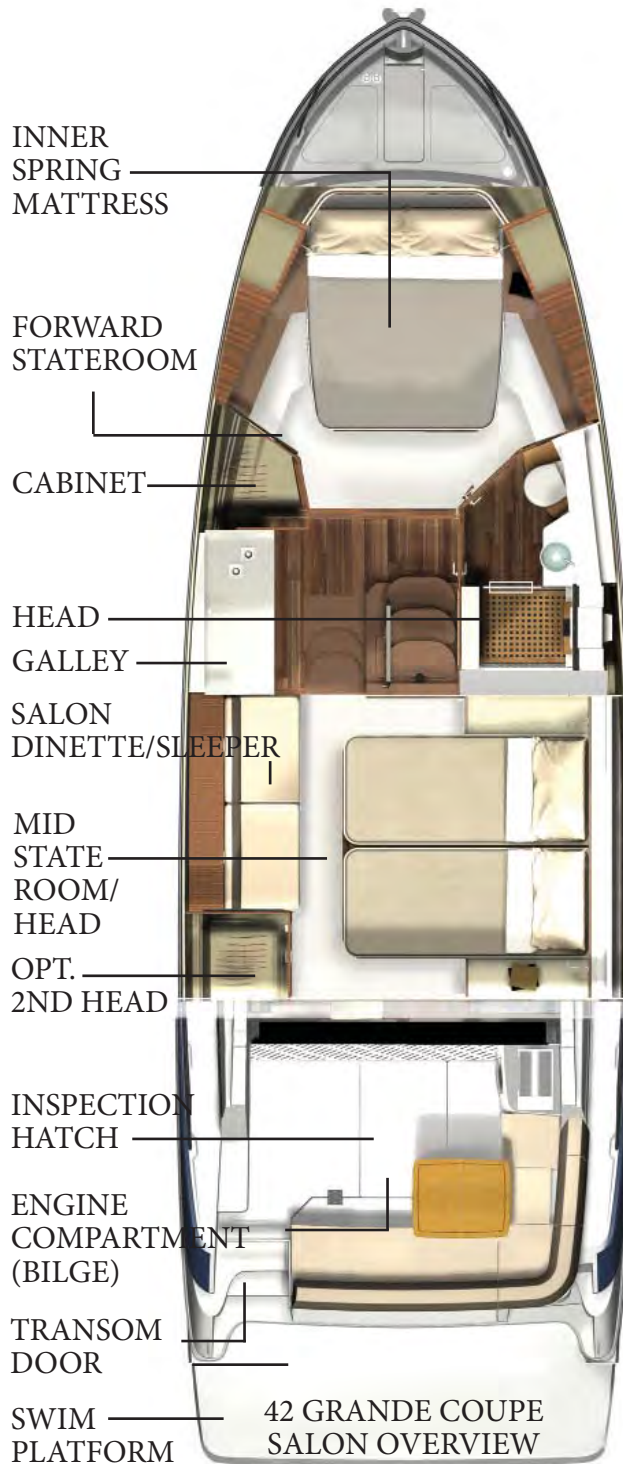

*NOTE: NOT TO SCALE/SELECT FEATURES SHOWN



42 FLYBRIDGE FEATURES

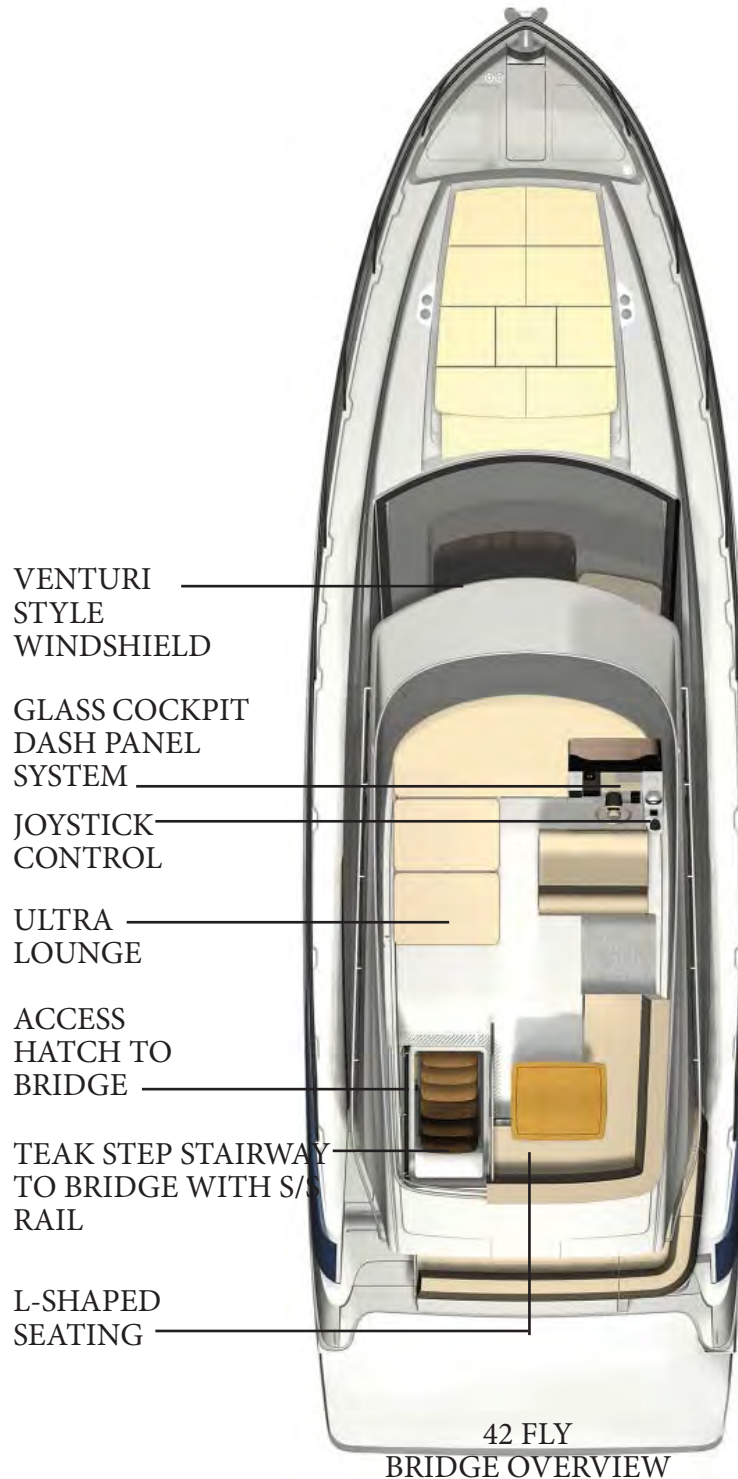

*NOTE: NOT TO SCALE/SELECT FEATURES SHOWN



TECHNICAL DRAWINGS

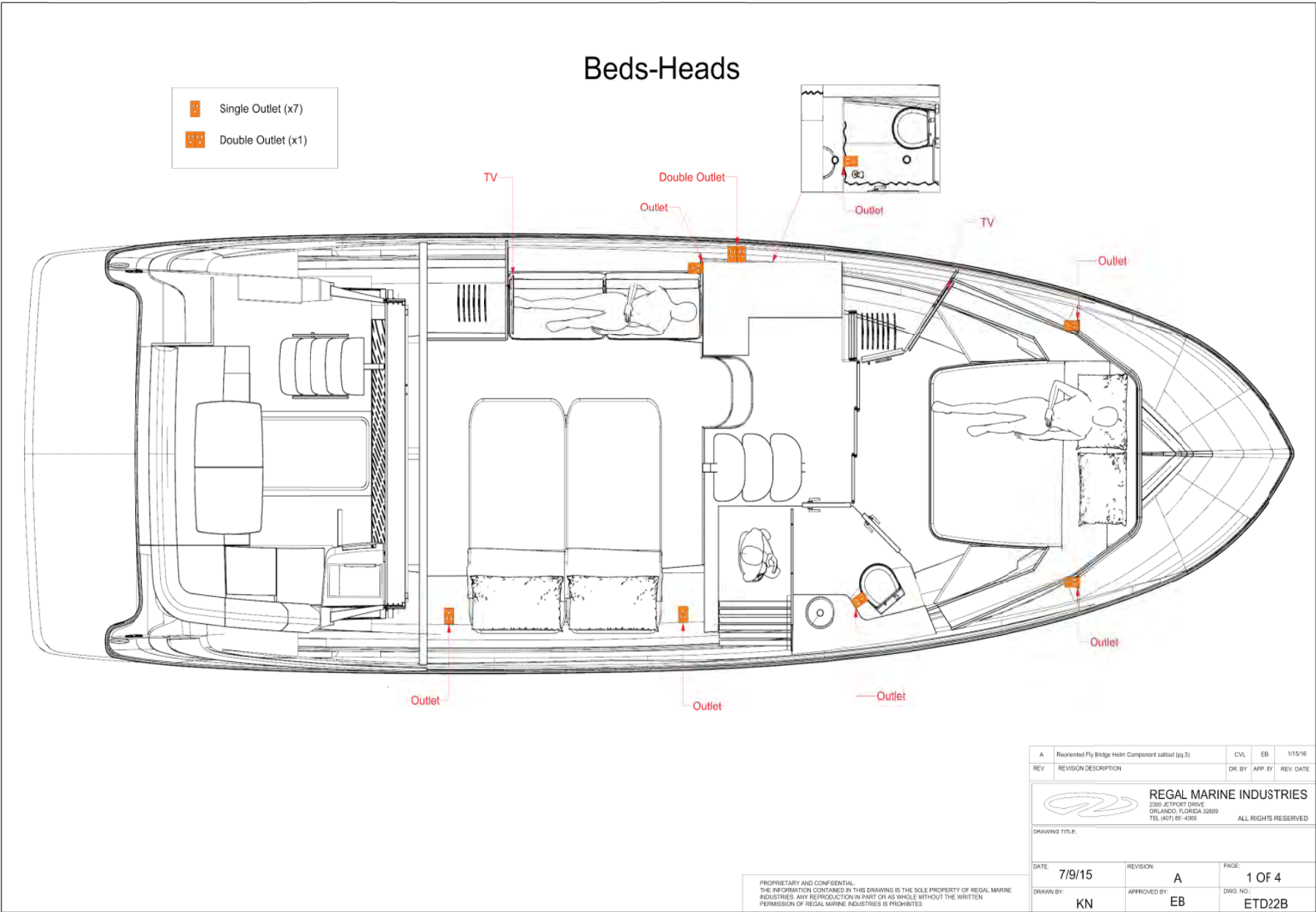

42 GRANDE COUPE/FLY ELECTRICAL OULLETS

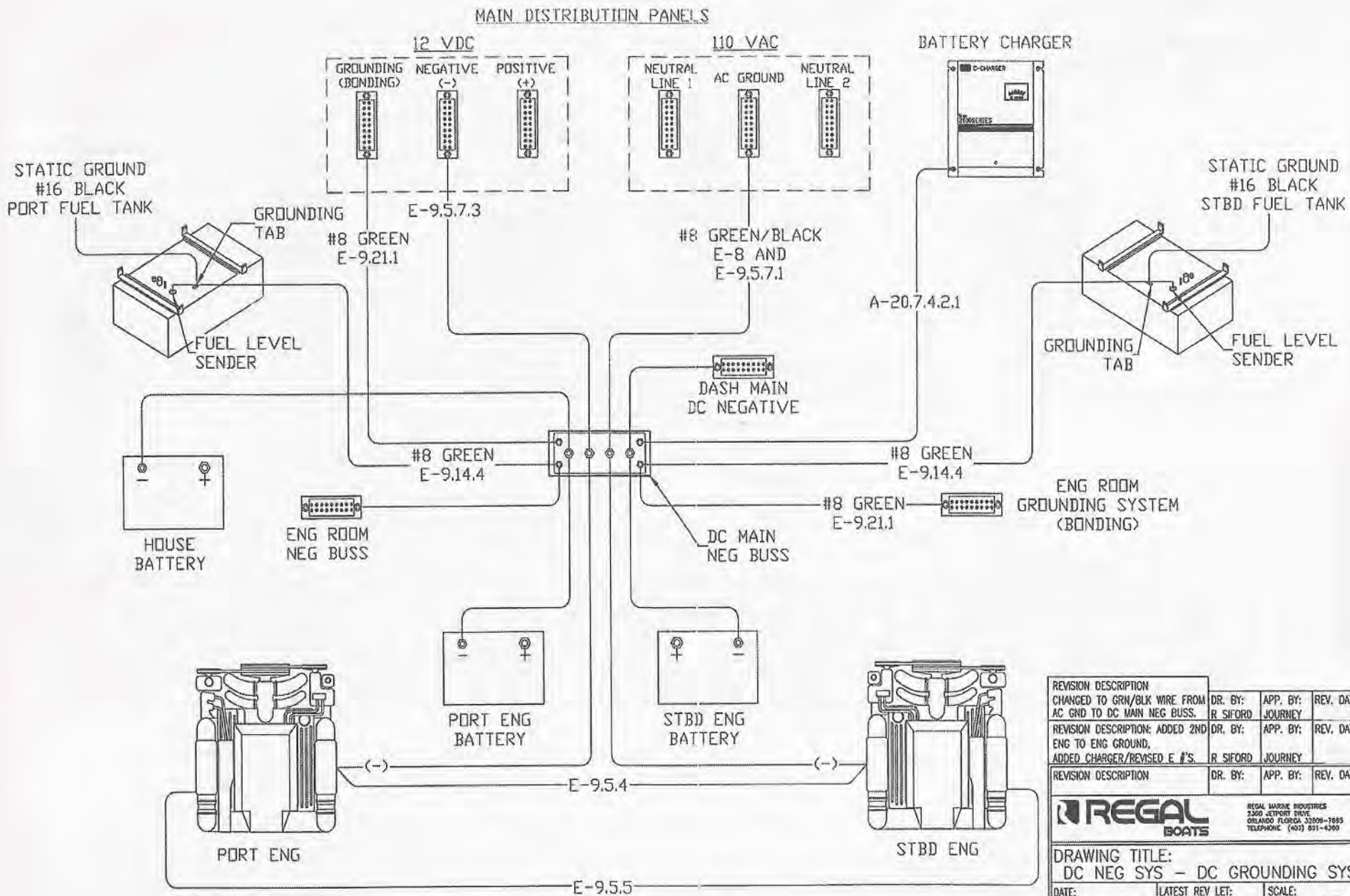

REVISION DESCRIPTION CHANGED TO GRN/BLK WIRE FROM AC GND TO DC MAIN NEG BUSS.	DR. BY: R SIFORD	APP. BY:	REV. DATE:
REVISION DESCRIPTION: ADDED 2ND ENG TO ENG GROUND, ADDED CHARGER/REVISED E. #'S.	DR. BY: R SIFORD	APP. BY: JOURNEY	REV. DATE:

REVISION DESCRIPTION	DR. BY:	APP. BY:	REV. DATE:
----------------------	---------	----------	------------

REGAL BOATS

REGAL MARINE INDUSTRIES
2300 JETPORT DRIVE
ORLANDO FLORIDA 32809-7685
TELEPHONE (407) 651-4369

DRAWING TITLE:
DC NEG SYS - DC GROUNDING SYS

DATE:	LATEST REV LET:	SCALE:	NTS
DR. BY:	APP. BY:	DWG. NO.:	

TYPICAL DC GROUND CIRCUITRY

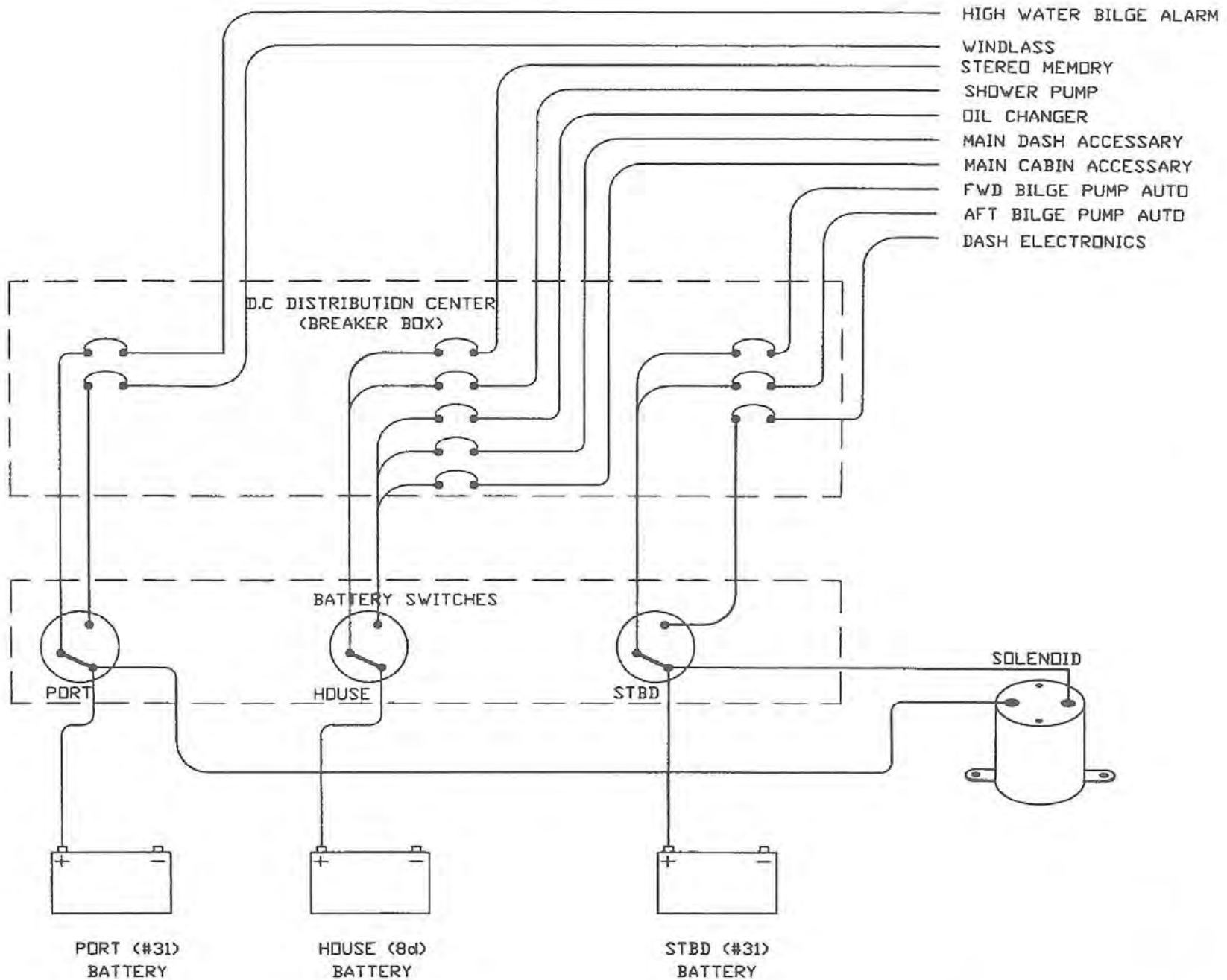

TYPICAL BATTERY MANAGEMENT PANEL CIRCUITRY

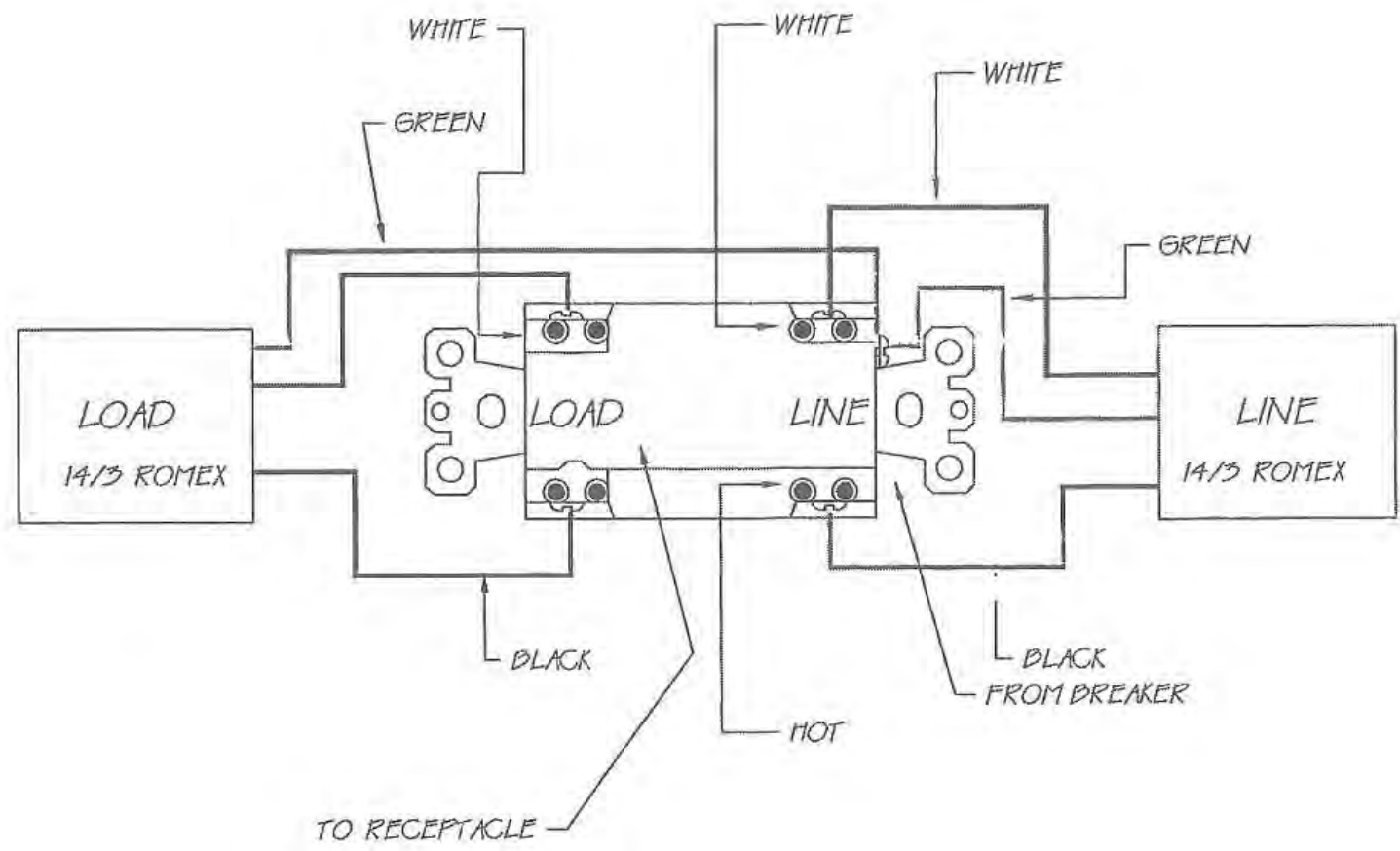

REVISION DESCRIPTION	DR. BY:	APP. BY:	REV. DATE:
		REGAL MARINE INDUSTRIES 2322 WETPORT BLVD ORLANDO FLORIDA 32809-7895 TELEPHONE (407) 651-4500	
DRAWING TITLE:			
110 VOLT GROUND FAULT CIRCUIT INTERRUPTER			
DATE:	LATEST REV LET:	SCALE:	
DR. BY:	APP. BY:	DWG. NO.:	

TYPICAL GFCI CIRCUITRY

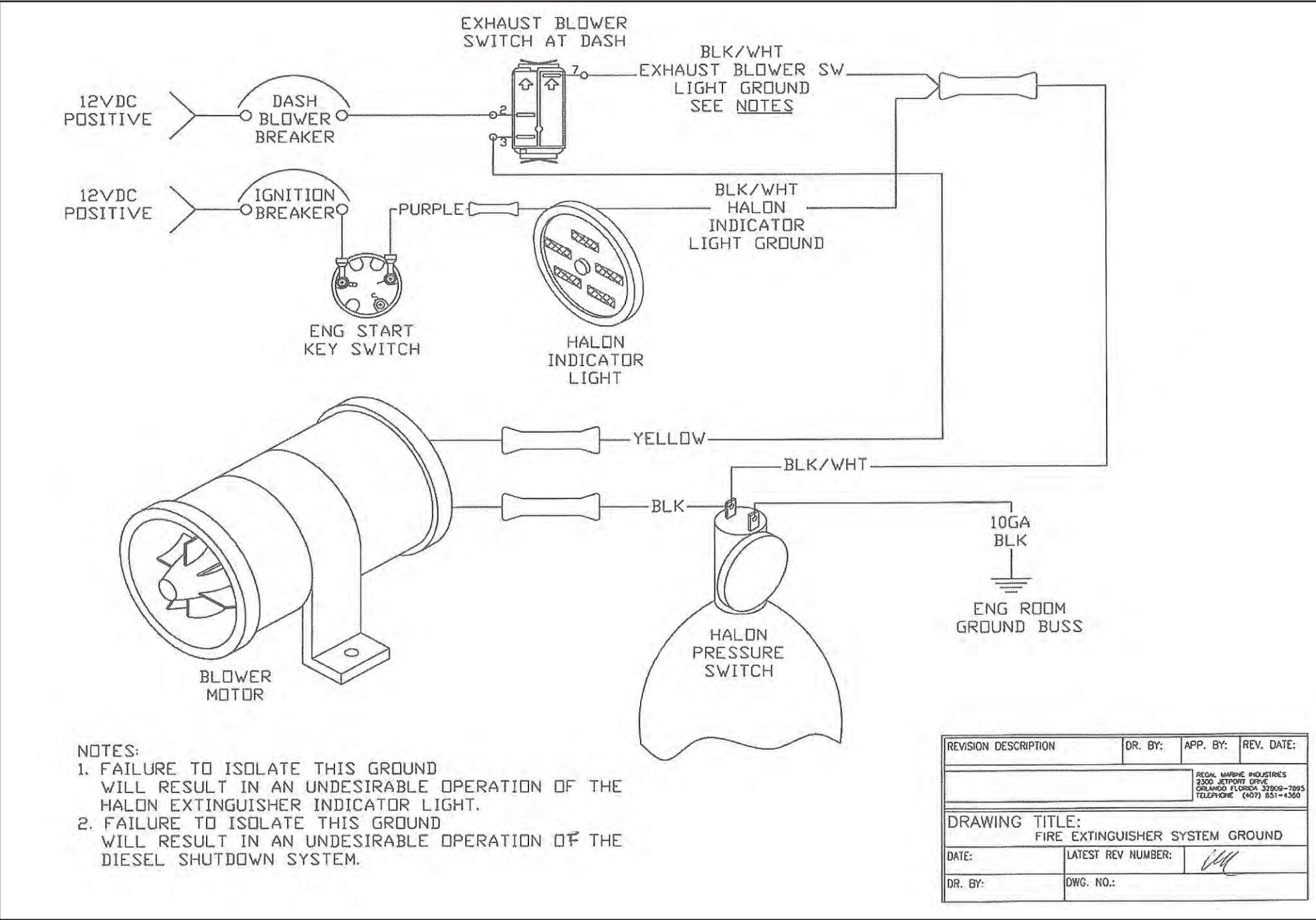

TYPICAL FIRE EXTINGUISHER GROUND CIRCUITRY

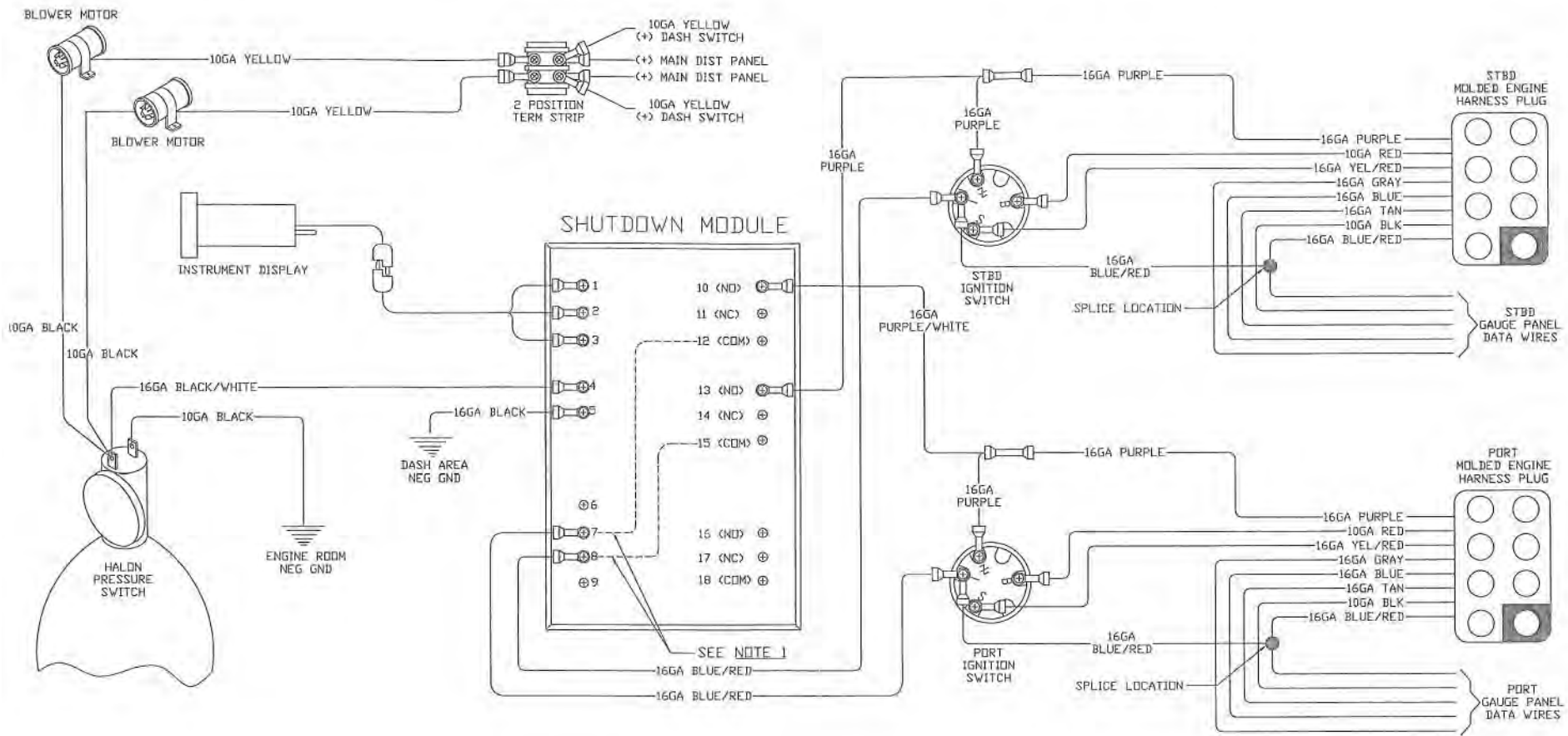

- NOTES:
1. THE CONNECTION BETWEEN TERMINALS #8 AND #15, #7 AND #12 ARE INTERNAL.
 2. THIS DWG IS FOR TWIN VOLVO DIESEL INSTALLATIONS THAT DO NOT USE THE BLACK BOX CONVERSION.

REVISION DESCRIPTION	DR. BY:	APP. BY:	REV. DATE:
 REGAL <i>Living Performance Boats</i>			
REGAL MARINE INDUSTRIES 2300 JEFFERSON DRIVE ORLANDO FLORIDA 32809-7895 TELEPHONE: (407) 851-4280			
DRAWING TITLE: VOLVO DIESEL TWIN ENG FIRE EXT SHUTDOWN			
DATE:	LATEST REV LET:	SCALE:	NTS
DR. BY: R SIFORD	APP. BY: 	DWG. NO.:	WS-212

TYPICAL TWIN VOLVO DIESEL ENGINE FIRE EXT. SHUTDOWN

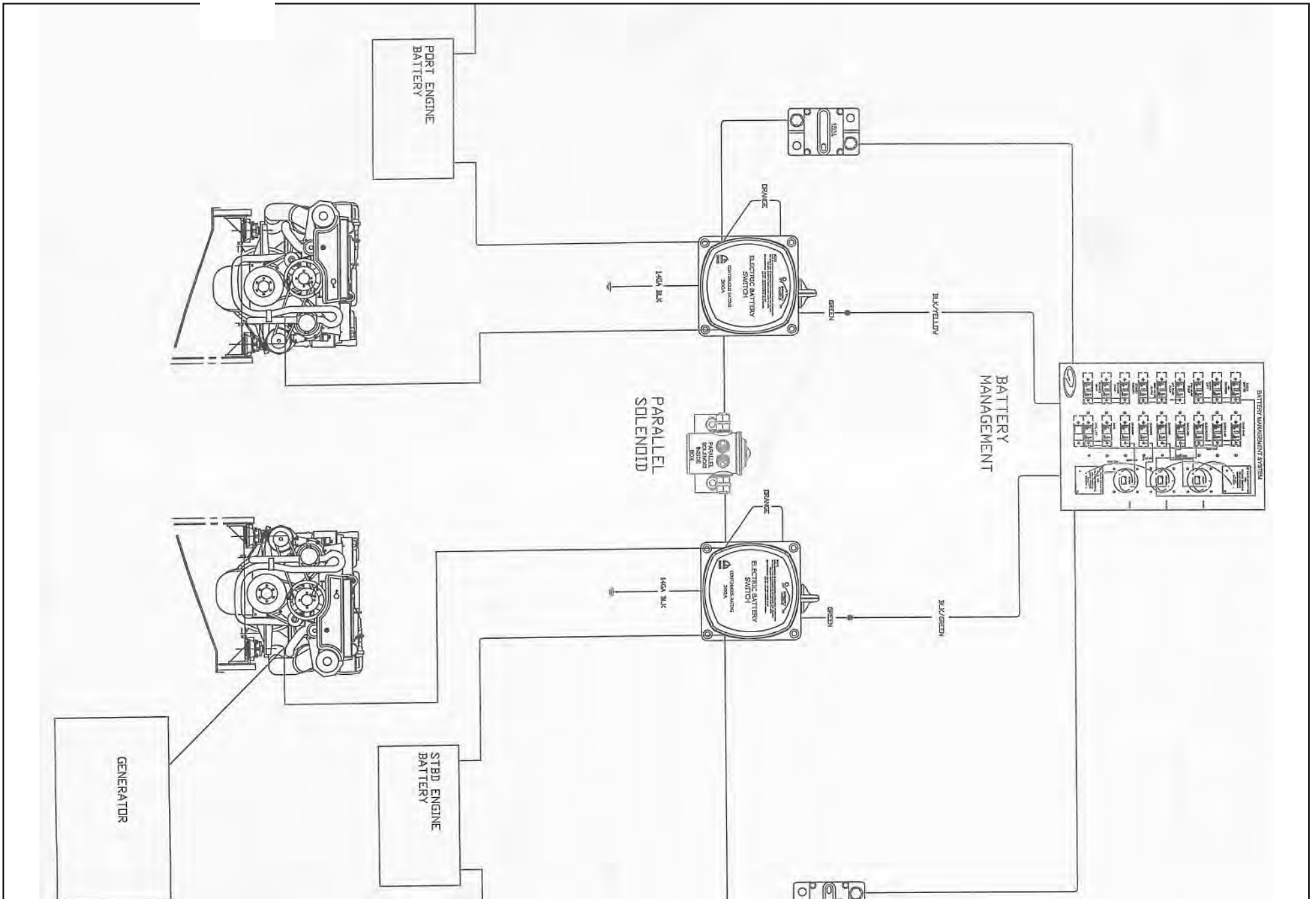

TYPICAL BATTERY SWITCH CIRCUITRY

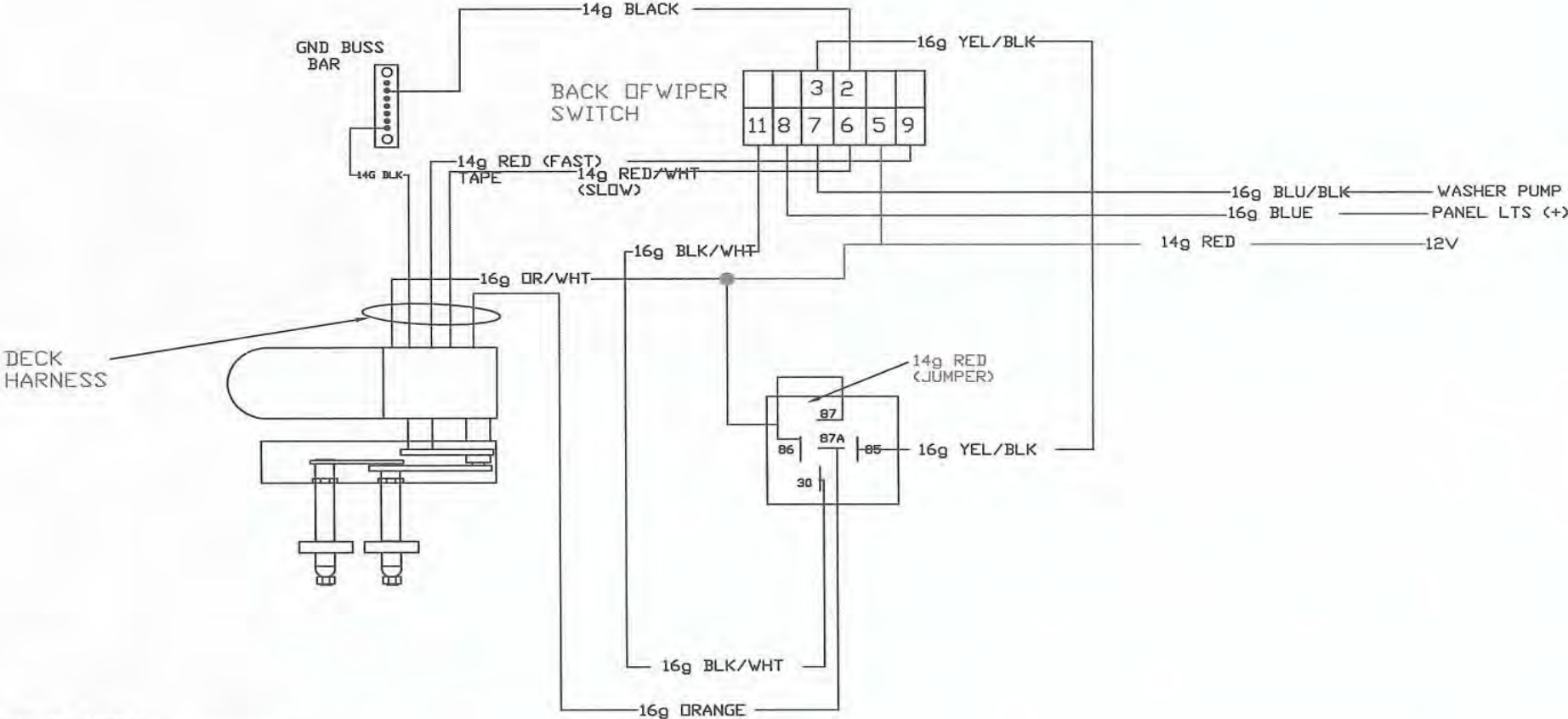

WIRING AT WIPER:
 BLACK HARNESS TO BLACK WIPER
 RED WHITE HARNESS TO BLUE/YEL WIPER
 ORANGE HARNESS TO BLUE/BLK WIPER
 ORANGE/WHT HARNESS TO BLUE/RED WIPER
 RED HARNESS TO BLUE WIPER

WIPER WIRING CODE ON WIPER PLUG:
 BLACK = "GROUND"
 BLUE/BLK = "SWITCH"
 BLUE/RED = "PARK"
 BLUE = "FAST"
 BLUE/GRN = "SLOW"

REVISION DESCRIPTION	DR. BY:	APP. BY:	REV. DATE:
			REGAL MARINE INDUSTRIES 2300 JETPORT DRIVE ORLANDO FLORIDA 32809-7895 TELEPHONE (407) 851-4360
DRAWING TITLE: WIPER SWITCH WIRING			
DATE: 1/29/09	CHECK BY:	PAGE NO.: 1 OF 1	
DR. BY: M. GARCIA/R. GILLS	APP. BY: R. GILLS	DWG. NO.: WI- 872	

TYPICAL WIPER CIRCUITRY OVERVIEW

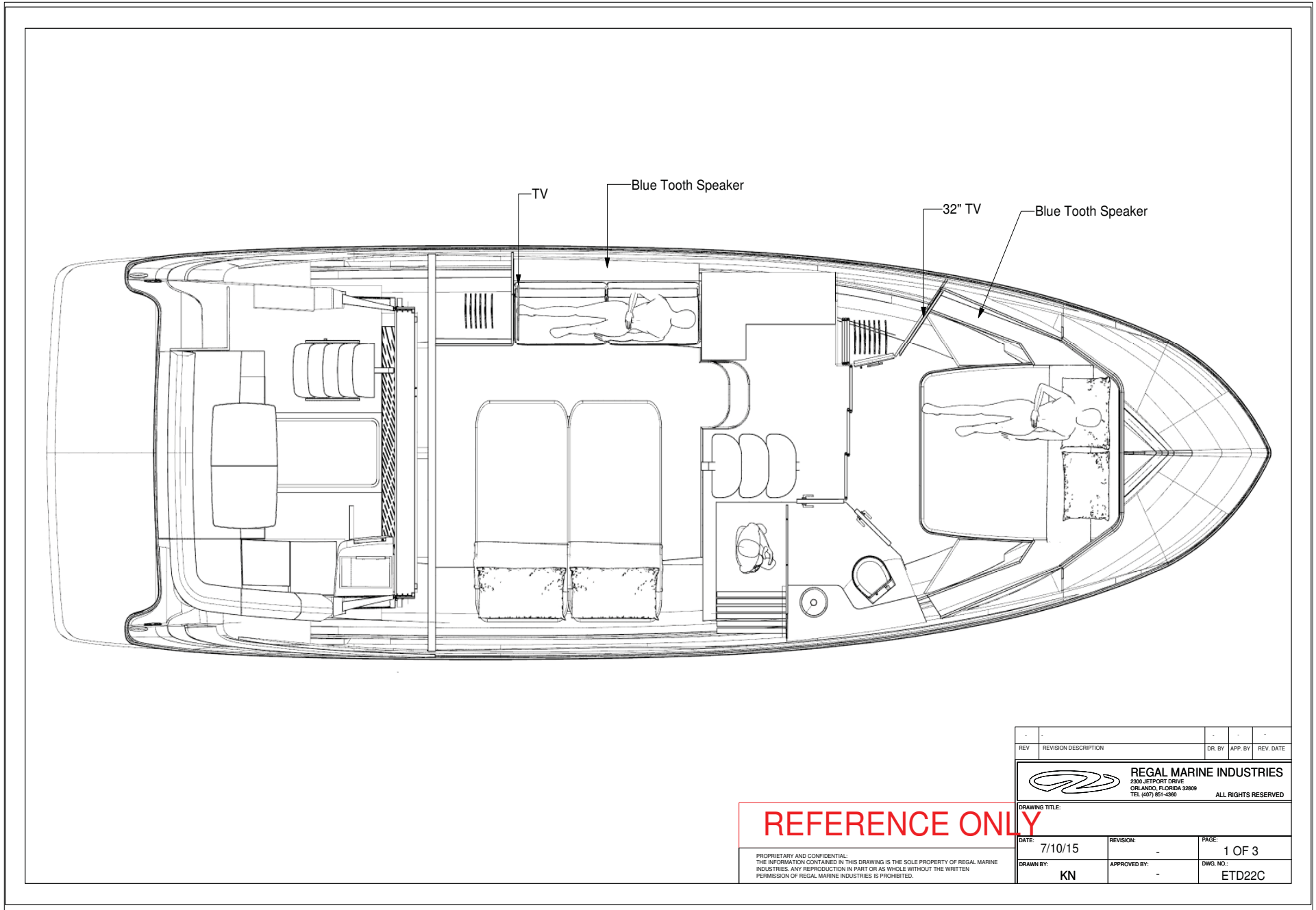

REV	REVISION DESCRIPTION	DR. BY	APP. BY	REV. DATE
-	-	-	-	-

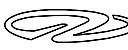
REGAL MARINE INDUSTRIES
 2300 JETPORT DRIVE
 ORLANDO, FLORIDA 32809
 TEL. (407) 951-4300 ALL RIGHTS RESERVED

DRAWING TITLE:

REFERENCE ONLY

DATE:	7/10/15	REVISION:	-	PAGE:	1 OF 3
DRAWN BY:	KN	APPROVED BY:	-	DWG. NO.:	ETD22C

PROPRIETARY AND CONFIDENTIAL:
 THE INFORMATION CONTAINED IN THIS DRAWING IS THE SOLE PROPERTY OF REGAL MARINE INDUSTRIES. ANY REPRODUCTION IN PART OR AS WHOLE WITHOUT THE WRITTEN PERMISSION OF REGAL MARINE INDUSTRIES IS PROHIBITED.

42 GRANDE COUPE/FLY ENTERTAINMENT COMPONENT LOCATIONS

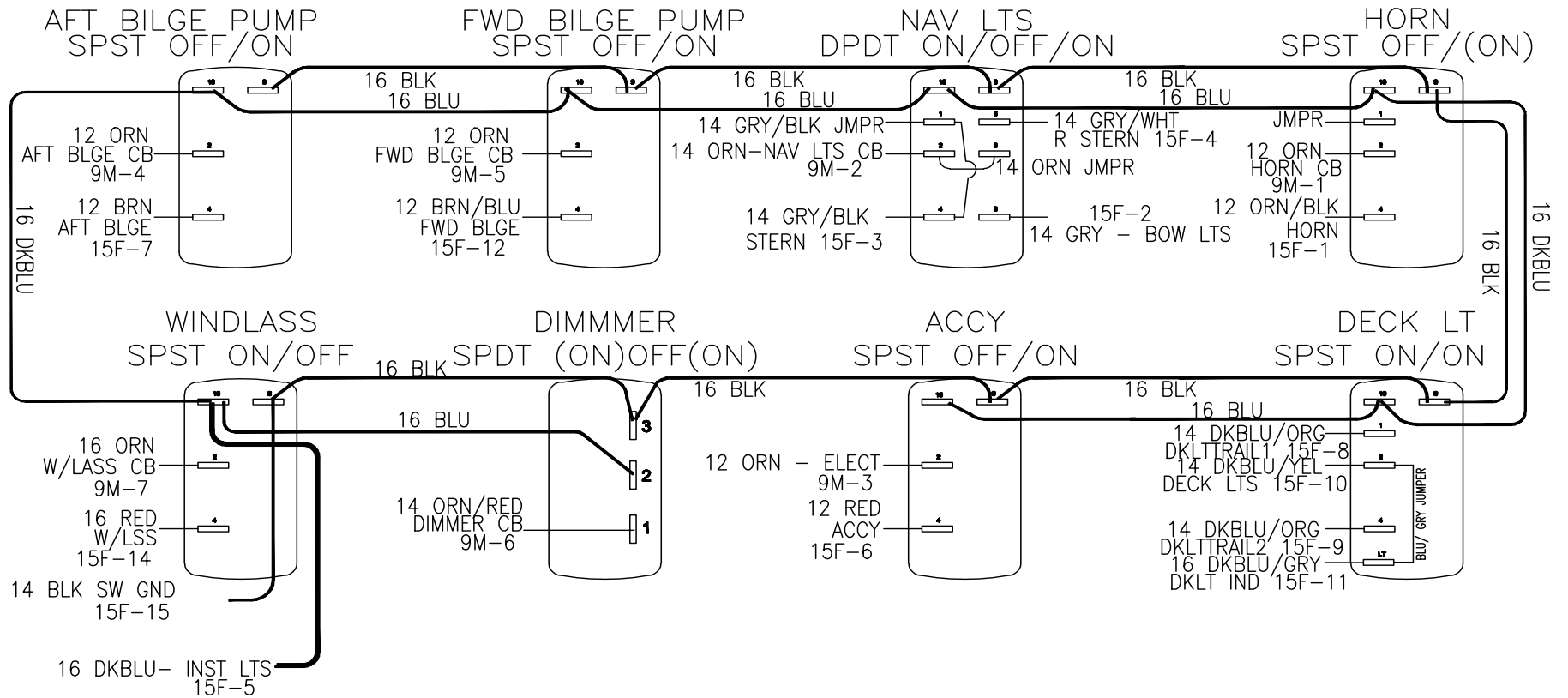
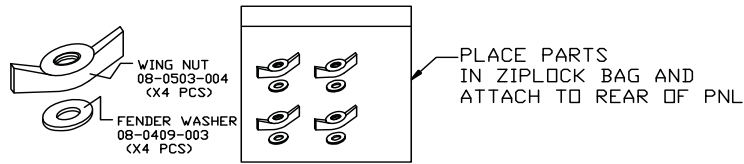

REGAL MARINE 2016
40 UPPER HELM SWP

B	R24809	PEM STUD WAS 080604075	09-01-15	MEM
PROTO	28486	BOM/WIRING ADJUSTMENTS	02-09-16	MEM
PR1	28812	REPROTO W/ CHNGS X 2 PCS	05-16-16	JTD
A	28812A	RELEASE TO PRODUCTION	07-25-16	JTD
REV.	ECN#	DESCRIPTION	DATE	BY

NOTES:
90-0003-763

Kauffman
Engineering Inc

85233545A
12-16-15
SHEET 1 OF 1

42 FLY UPPER HELM SWITCH PANEL

Technical Information

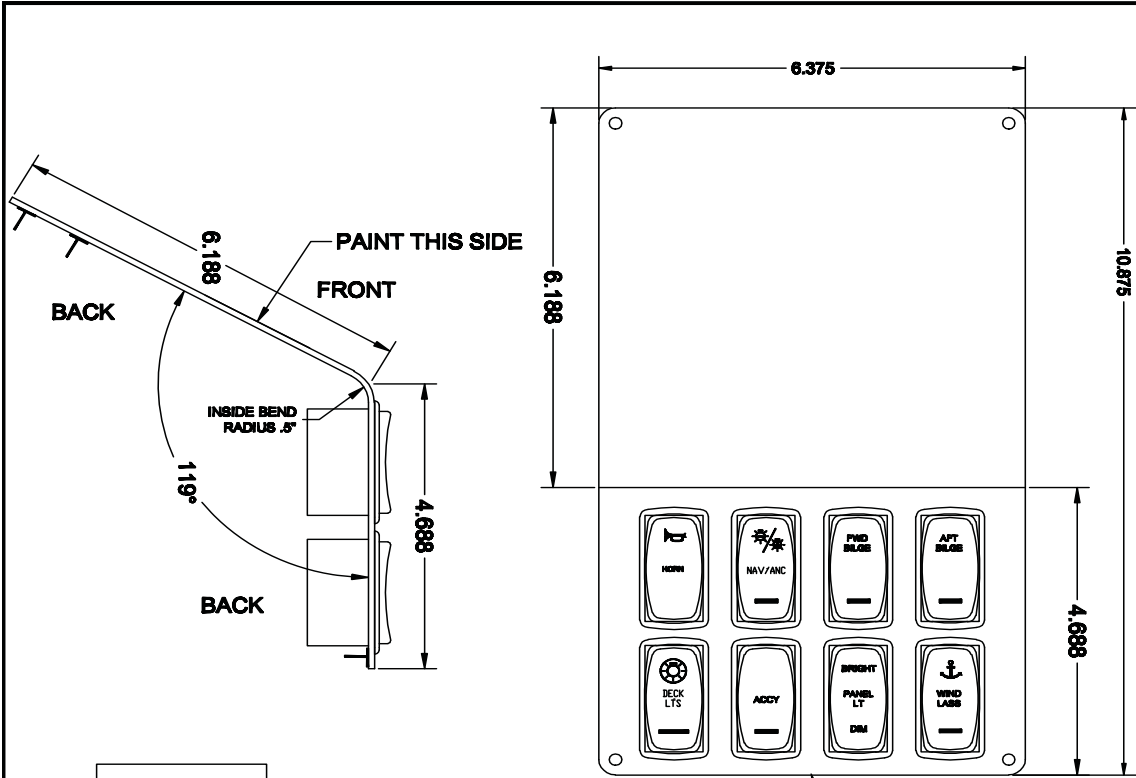

GENERAL INFORMATION:

SWITCHES:		L - SERIES SWITCH
P/N	QTY.	DESCRIPTION
011903001	1	(ON)OFF SPST "HORN"
011901011	1	ON/OFF SPST "AFT BILGE"
011901018	1	ON/OFF SPST "FWD BILGE"
011902001	1	ON/OFF/ON DPDT "NAV/ANC LTS"
011901030	1	ON/OFF SPST "WINDLASS"
011901006	1	(ON)OFF(OFF) "DIMMER"
011901002	1	ON/OFF DPST "ELECT"
011906002	1	ON/ON SPST "DECK LTS"

ACCESSORY ITEMS:

P/N	QTY.	DESCRIPTION
080409003	4	#8 FENDER WASHER
080503004	4	#8 -32 WINGNUT
320107012	1	4 X 4 ZIPLOCK
140101001	1	TIEWRAP

HARNESS:

P/N	QTY.	REV.	DESCRIPTION
900003763	1	A	PANEL WIRING

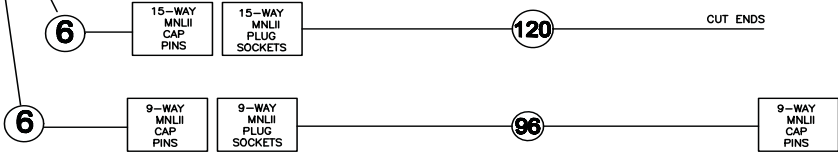
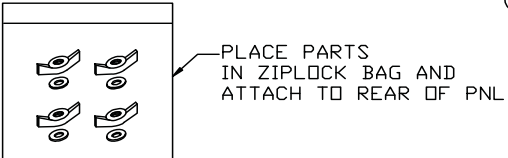

BIPS: PAINTED BLACK WITH GLOSS CLEARCOAT
 P/N QTY. REV. DESCRIPTION
 8906544 1 B PAINTED 230109583 (MADE FR. 23-0109-588)

ORDERING INFORMATION:

KIT #	KE P/N	DESCRIPTION	CUST P/N
	85233545	40 UPR HELM	401796

REGAL MARINE 2016
 40 UPPER HELM SWP

REV.	ECN#	DESCRIPTION	DATE	BY
B	R24809	PEM STUD WAS 080604075	09-01-15	MEM
PROTO	28486	BOM/WIRING ADJUSTMENTS	02-09-16	MEM
PR1	28812	REPROTO W/ CHNGS X 2 PCS	05-16-16	JTD
A	28812A	RELEASE TO PRODUCTION	07-25-16	JTD

NOTES:
 90-0003-763



85233545
 12-16-15
 SHEET 1 OF 1

42 FLY UPPER HELM SWITCH PANEL

Technical Information

04 26 16 – CHANGES TO PROTO

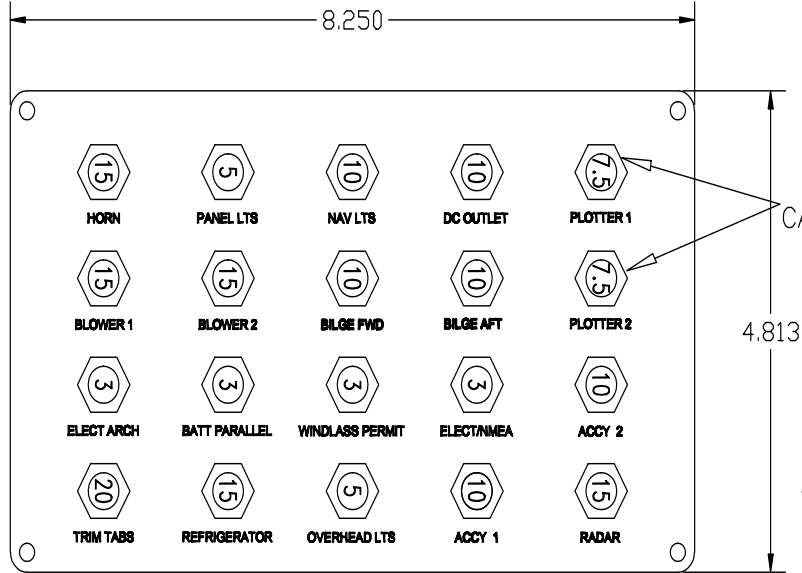

8 RED #ELECT — 8 RED #HELM 2 — 8 RED #HELM 1 —
 PLOTTERS
 MUST BE
 PUSH/PULL
 SO THEY
 CAN BE TURNED
 ON OR OFF

DON'T USE
 BOOTS ON
 ANY BREAKERS

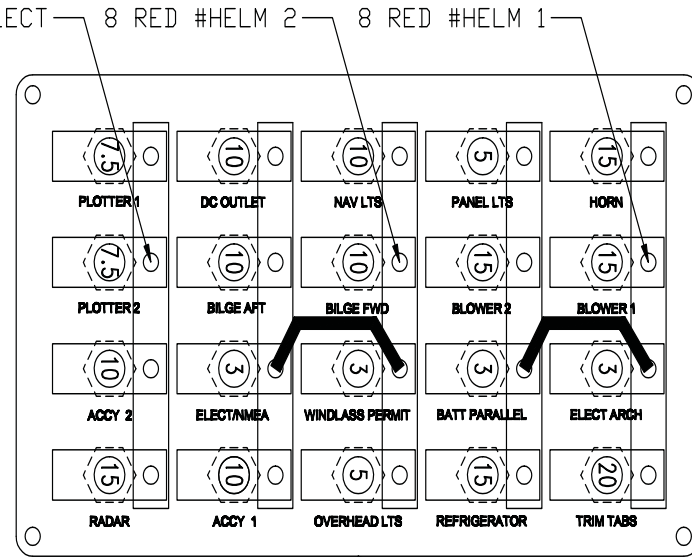

14 ORN – OVERHEAD LTS
 60 INCHES, CUT END, COIL HERE

11 30 15 – NEW 40 UPPER HELM BREAKER PANEL
 REGAL #401790, PAINT FLAT BLACK

- 9-WAY MNLII PLUG SOCKETS
- 1 – 12 ORN – HORN CB
 - 2 – 14 ORN – NAV LTS CB
 - 3 – 12 ORN – ELECTRONICS CB
 - 4 – 12 ORN – AFT BILGE CB
 - 5 – 12 ORN – FWD BILGE CB
 - 6 – 14 ORN/RED – DIMMER CB
 - 7 – 16 ORN – WINDLASS PERMIT CB
 - 8 – BLANK
 - 9 – BLANK

- 6-WAY PLUG / SOCKETS
- 1 – 14 ORN – PLOTTER 1
 - 2 – 14 ORN – PLOTTER 2
 - 3 – 16 ORN – ELECT ARCH
 - 4 – 14 ORN – DC OUTLET
 - 5 – 10 ORN – TRIM TABS
 - 6 – 14 ORN – ACCY 1

- 2-WAY PLUG / SOCKETS
- 1 – 10 ORN – REFRIGERATOR
 - 2 – 12 ORN – RADAR

- 4-WAY PLUG / SOCKETS
- 1 – 12 ORN – BLOWER 1
 - 2 – 12 ORN – BLOWER 2
 - 3 – 16 ORN – PARALLEL
 - 4 – 14 ORN – ACCY 2

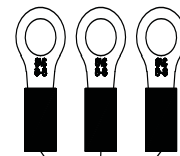

8 RED #HELM 1
 8 RED #HELM 2
 8 RED #ELECT
 3 RINGS
 LABEL EACH

48

12

60

TO UPPER SWP
 9-WAY
 PLUG
 SOCKETS

6-WAY
 PLUG
 SOCKETS

4-WAY
 PLUG
 SOCKETS

2-WAY
 PLUG
 SOCKETS

42 FLY UPPER HELM BREAKER PANEL

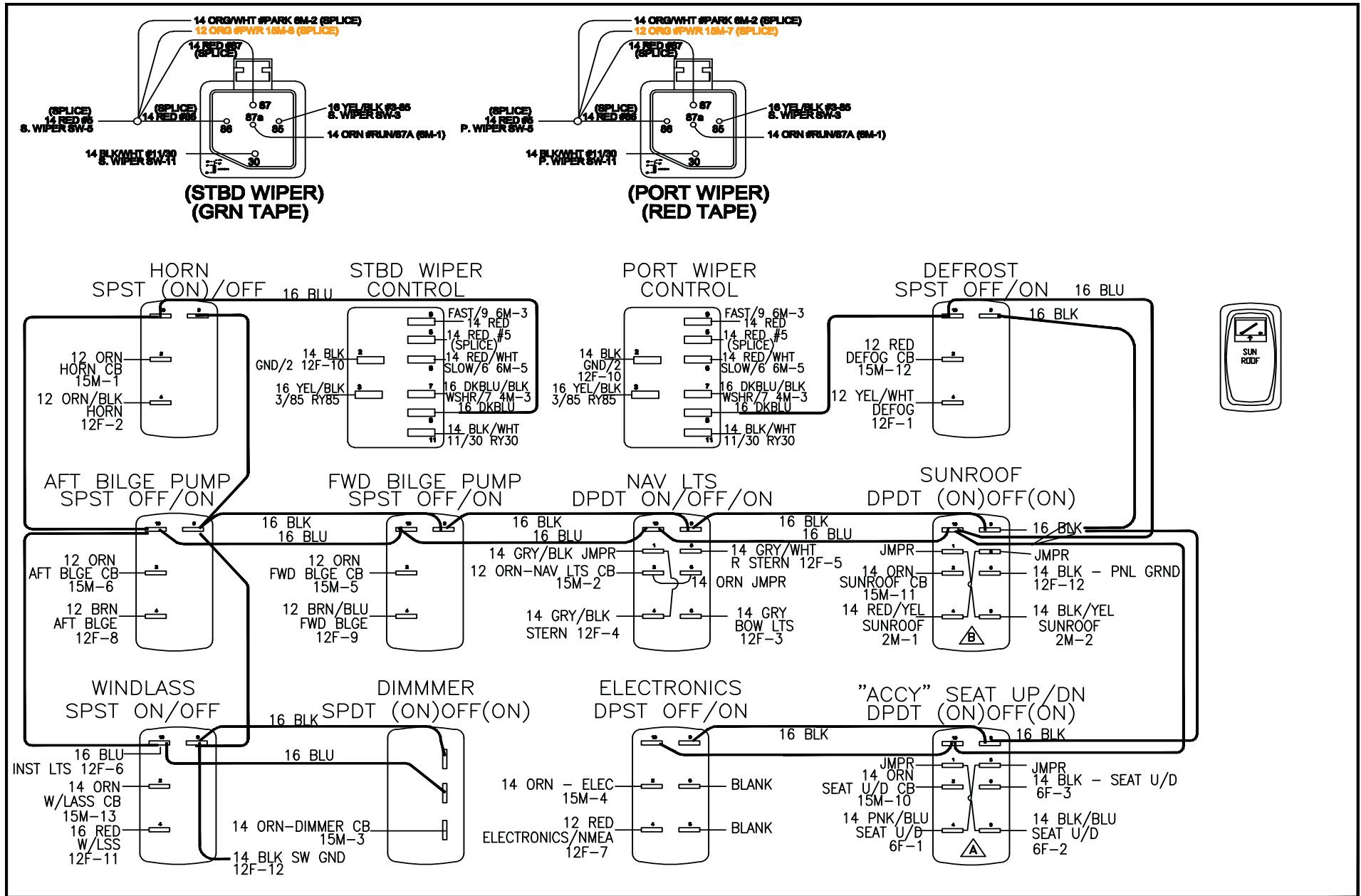

REGAL MARINE 2016
40 LWR HELM SWP

REV.	ECN#	DESCRIPTION	DATE	BY
A	28873A	RELEASE TO PRODUCTION	07-25-16	JTD
A	XXXXX	CORRECTED SEAT WIRING DETAIL	08-16-16	MEM
B	R24809	PEM STUD WAS 080604075	09-01-16	MEM
PR2	28873	REVISIONS TO PANEL ASSY	06-22-16	MEM

NOTES:
90-0003-764

Kauffman
Engineering Inc

85233546A
12-16-15
SHEET 1 OF 2

42 GRANDE COUPE/FLY LOWER HELM SWITCH PANEL

Technical Information

07 07 16 - CHANGED 2-WAY AND 4-WAY PIN OUTS
 REGAL 40 - LOWER HELM BREAKER PANEL - REGAL #401789

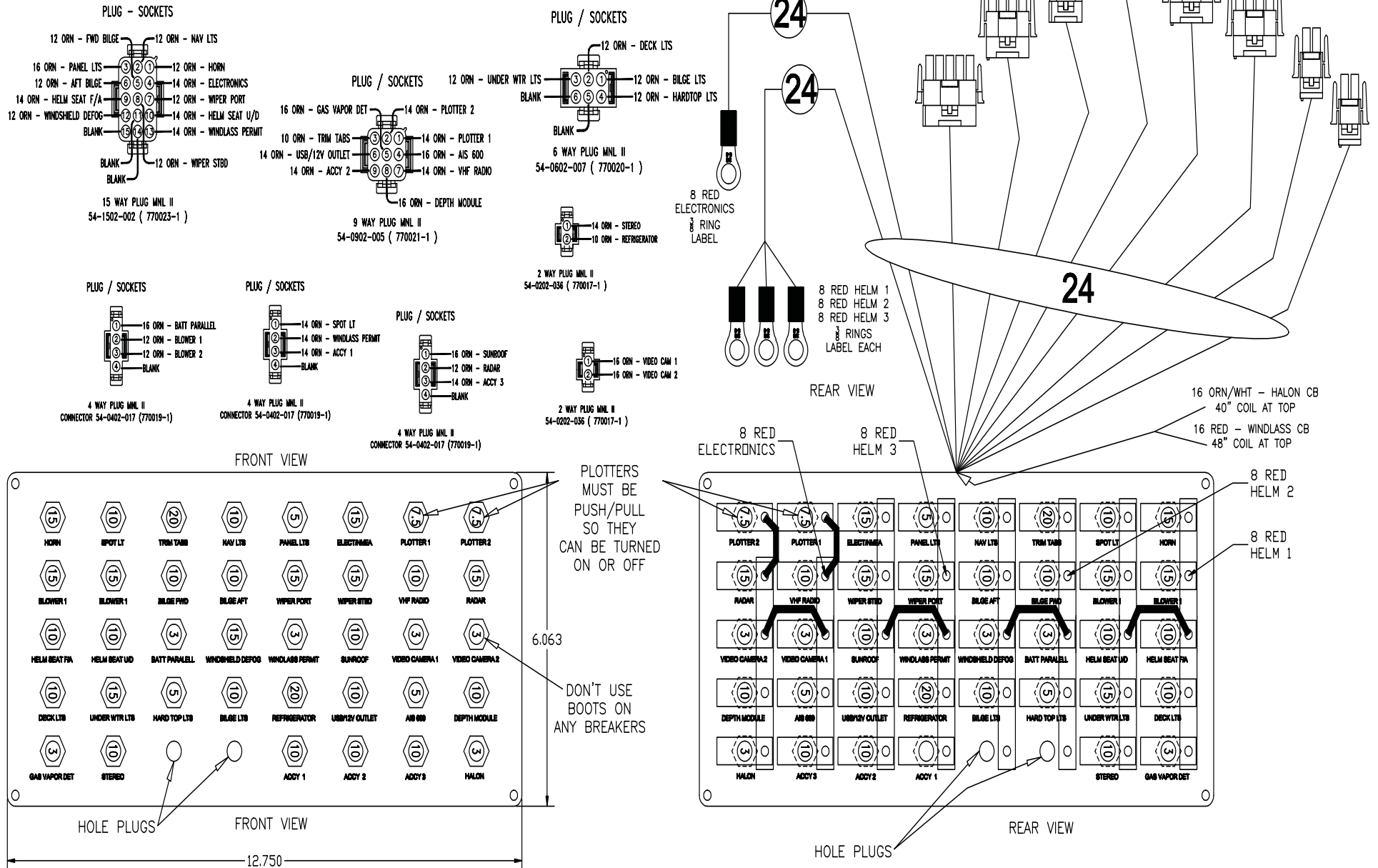

Technical Information

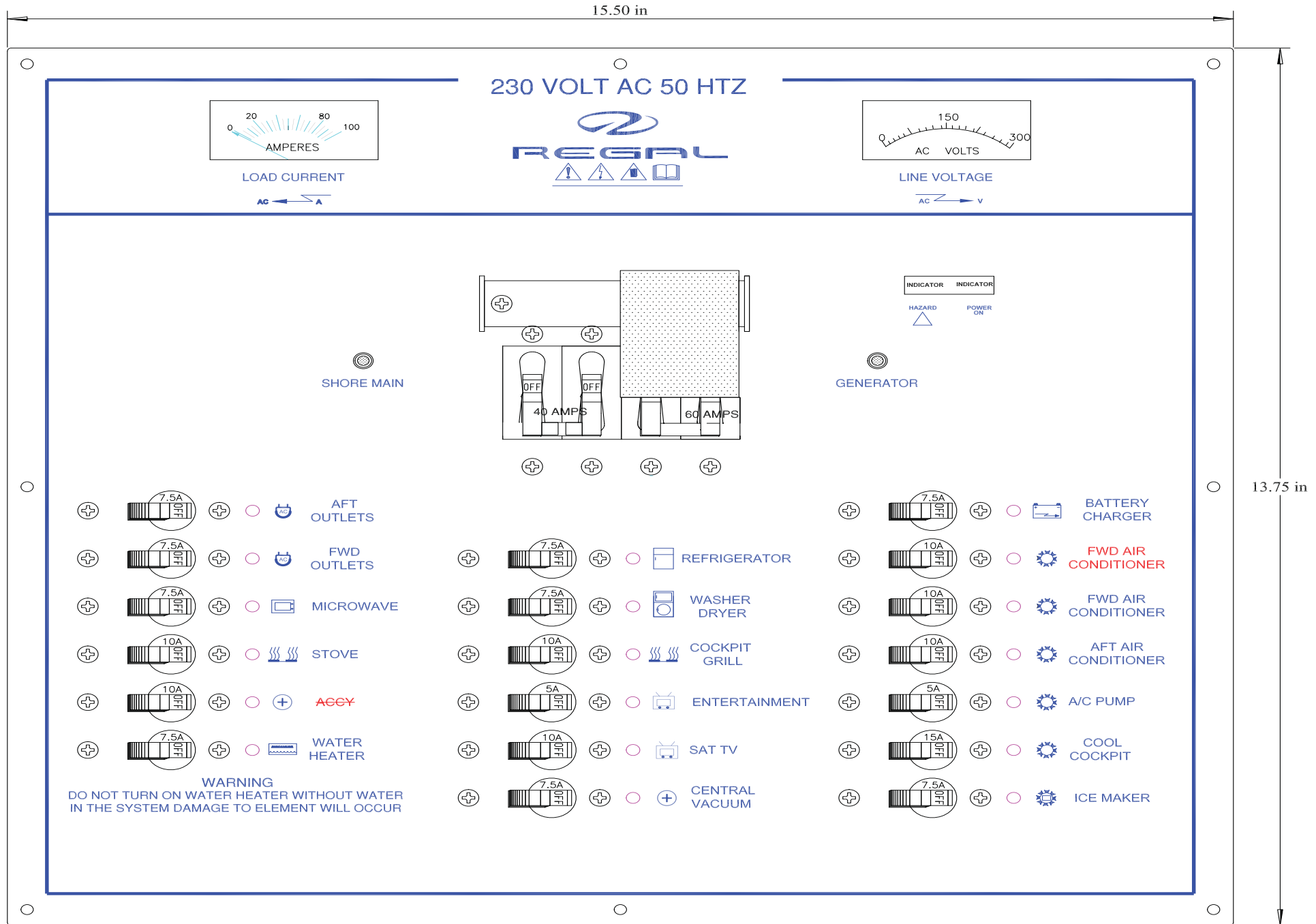

42 GRANDE COUPE/FLY EUROPEAN 230 VOLT AC PANEL

Technical Information

2/29/2016 CHANGE ARTWORK FROM STEREO TO TELEVISION
 4/29/2016 CHANGE FWD AND MID CABIN LTS TO 20A STABILIZER TO 15A

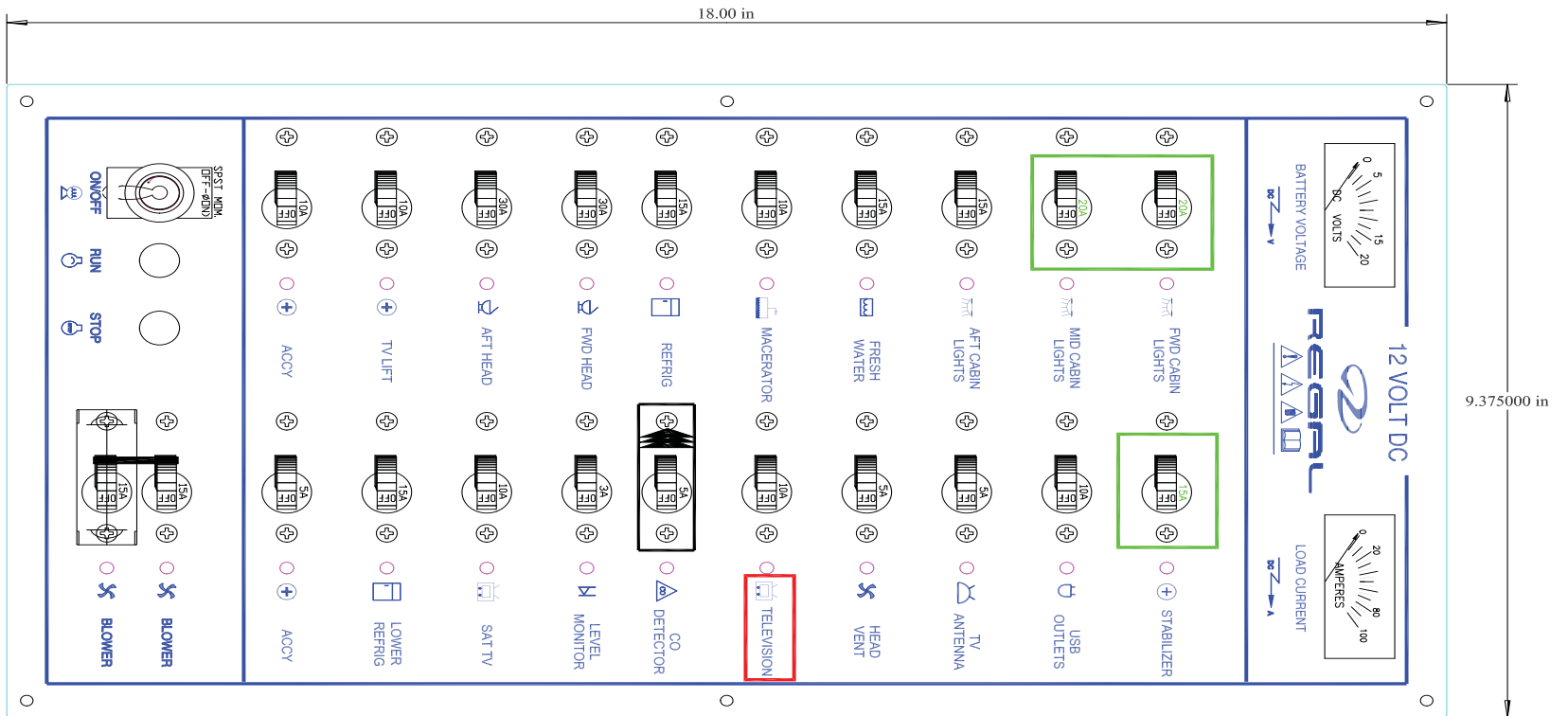

PART#401773

	REGAL BOATS		
	TITLE	40 12 VDC MDP	
SIZE	CAGE CODE	DWG NO	REV
SCALE	12/13/2015	401773	1
XR MARTIN		12/13/2015	SHEET

42 GRANDE COUPE/FLY 12 VOLT DC PANEL

42(TD/TF)

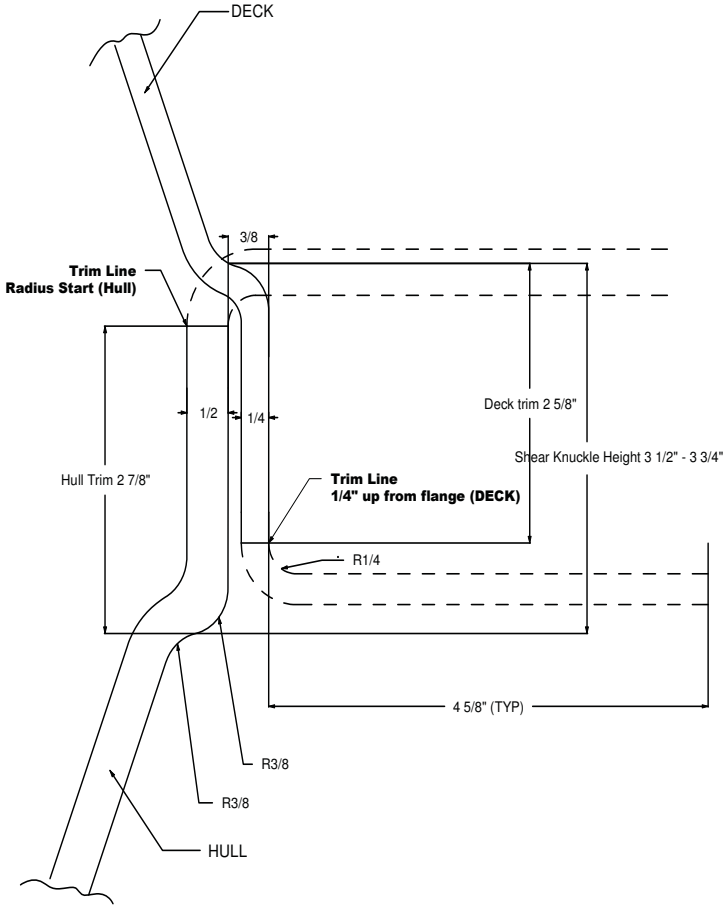

PROPRIETARY AND CONFIDENTIAL:
 THE INFORMATION CONTAINED IN THIS DRAWING IS THE SOLE PROPERTY OF REGAL MARINE INDUSTRIES. ANY REPRODUCTION IN PART OR AS WHOLE WITHOUT THE WRITTEN PERMISSION OF REGAL MARINE INDUSTRIES IS PROHIBITED.

REV	REVISION DESCRIPTION	DR. BY	APP. BY	REV. DATE
-	-	-	-	-

REGAL MARINE INDUSTRIES
 2300 JETPORT DRIVE
 ORLANDO, FLORIDA 32809
 TEL (407) 851-4360
 ALL RIGHTS RESERVED

DRAWING TITLE:
42(TD/TF) Hull-Deck Trim Requirements

DATE: 7/29/15	REVISION: -	PAGE: 1 OF 1
DRAWN BY: KN	APPROVED BY: MW	DWG. NO.: MTD23A

42 GRANDE COUPE/FLY HULL/DECK TRIM

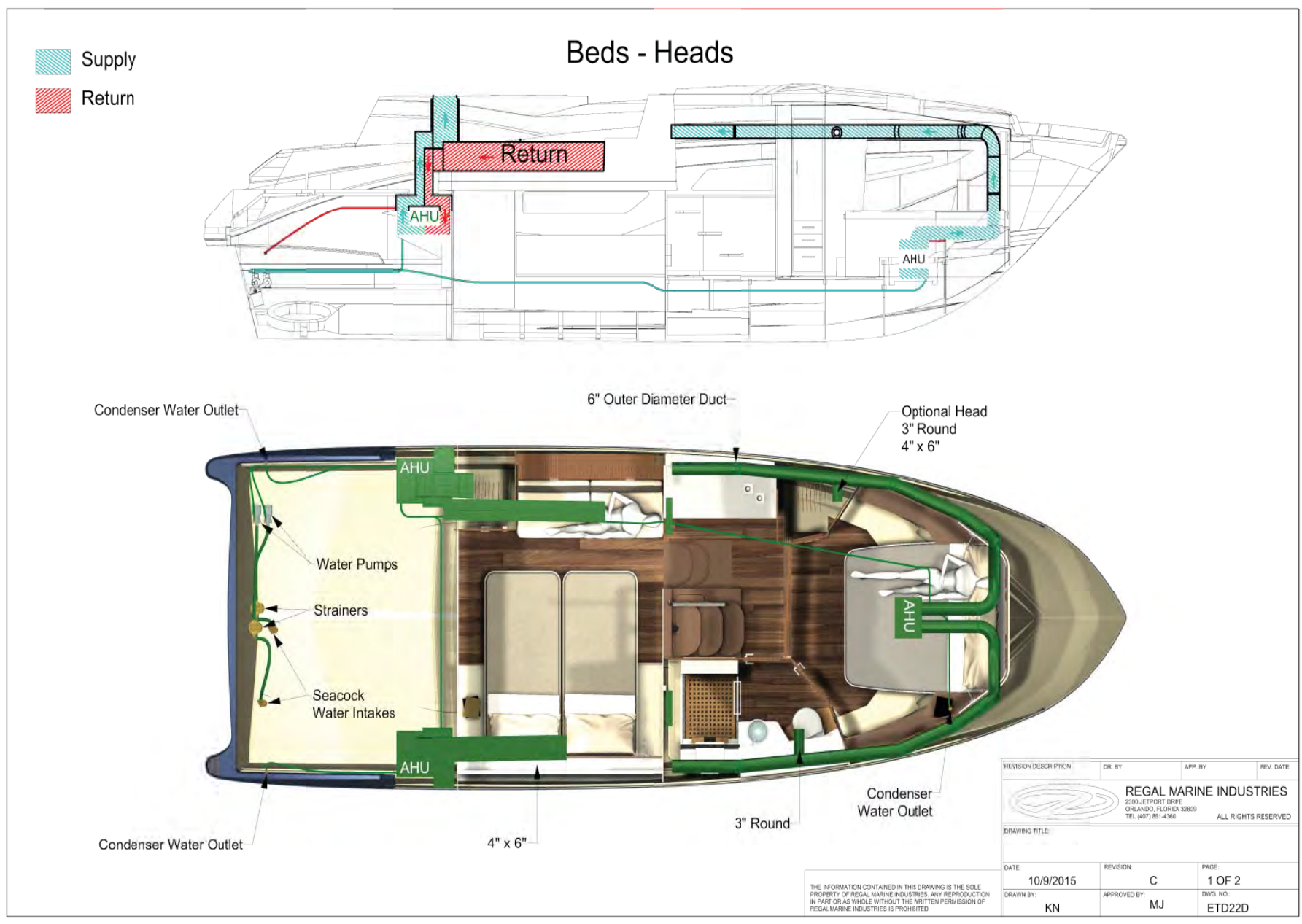

42 GRANDE COUPE/FLY AIR CONDITIONING SYSTEM OVERVIEW

Item	Name	Notes	Item	Name	Notes	Item	Name	Notes	Item	Name	Notes
1	Fireboy Bracket	Dimension to bracket edge	4	Mastervolt Chargemaster		7	Negative Bus Bar		10	U-Lube Option	
2	Ground Bus Bar		5	Battery Management Panel		8	Positive Bus Bar				
3	Junction Box		6	Battery Switch Panel		9	Dometic Pump Relay				

Firewall Dimensions

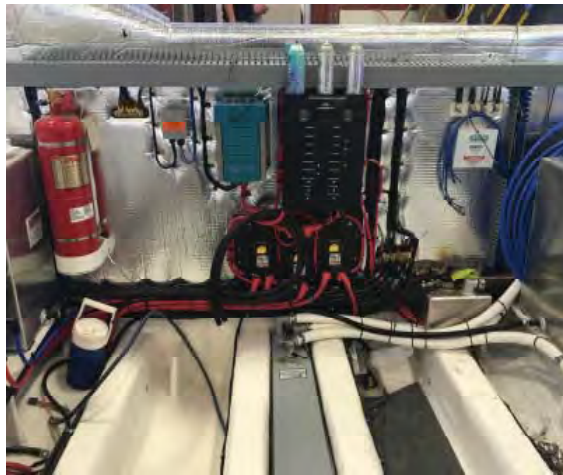
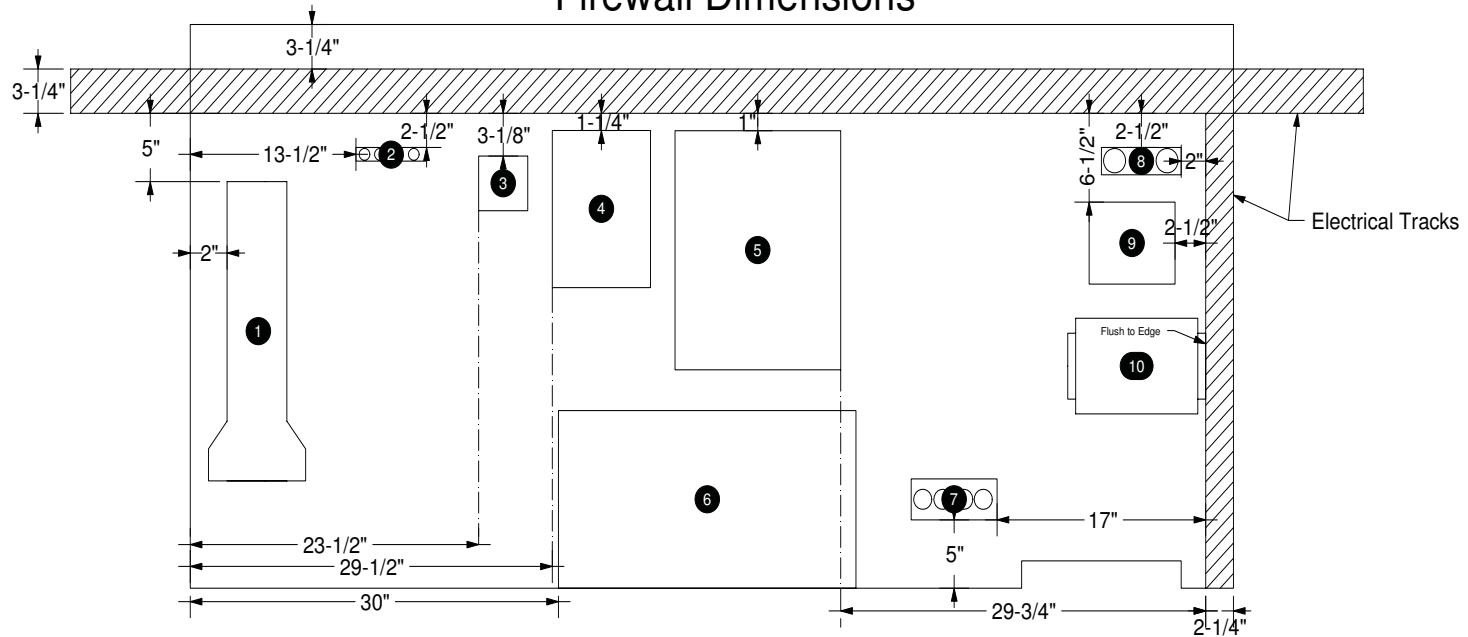

THE INFORMATION CONTAINED IN THIS DRAWING IS THE SOLE PROPERTY OF REGAL MARINE INDUSTRIES. ANY REPRODUCTION IN PART OR AS WHOLE WITHOUT THE WRITTEN PERMISSION OF REGAL MARINE INDUSTRIES IS PROHIBITED.

REVISION DESCRIPTION	DR. BY	APP. BY	REV. DATE
 REGAL MARINE INDUSTRIES 2300 JETPORT DRIVE ORLANDO, FLORIDA 32809 TEL. (407) 851-4369 ALL RIGHTS RESERVED			
DRAWING TITLE: 42 TD/TF Sump Layout			
DATE: 1/7/2016	REVISION: -	PAGE: 1 OF 2	
DRAWN BY: KN	APPROVED BY: MW	DWG. NO.: MTD23B	

42 GRANDE COUPE/FLY SUMP FIREWALL OVERVIEW

Fuel Tank Capacity: 258 Gal.

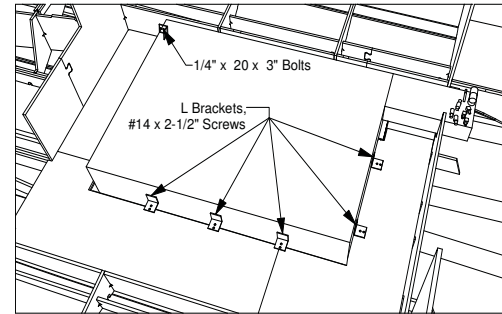
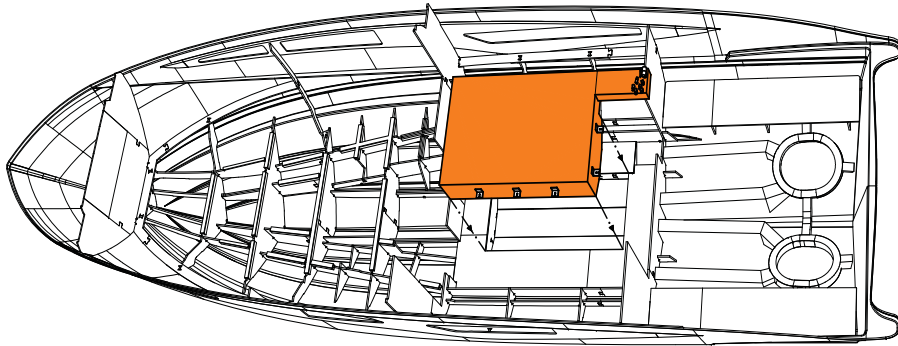

- █ Fuel Fill
- █ Feed Line
- █ Return Line

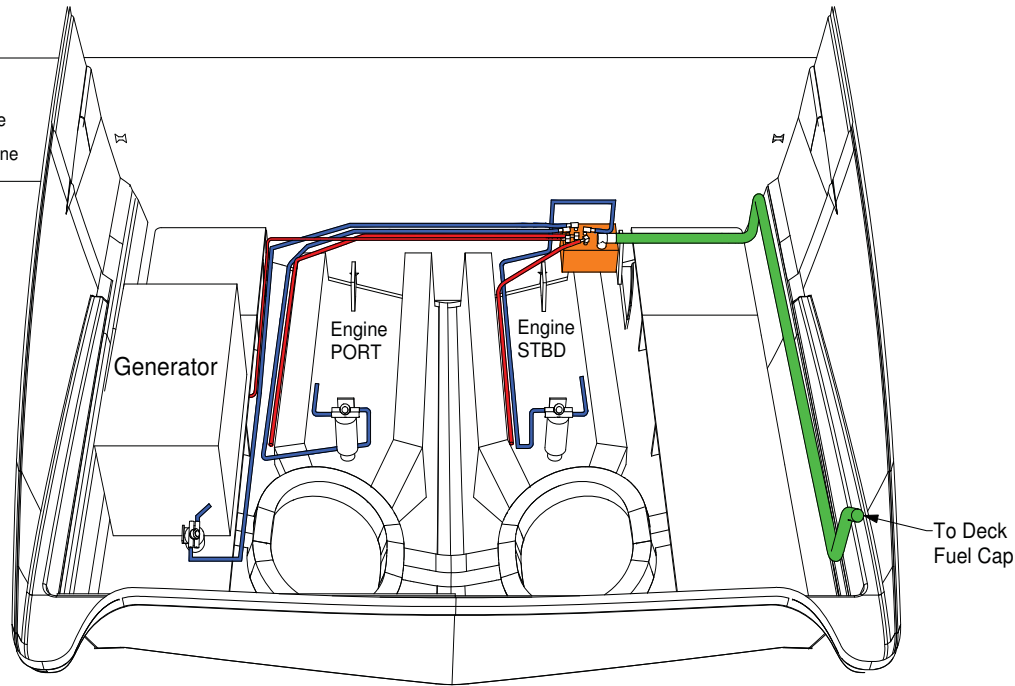

1	Vent	5	Generator Return
2	Fuel Fill	6	Engine Feed PORT
3	Engine Return STBD	7	Generator Feed
4	Engine Return PORT	8	Engine Feed STBD

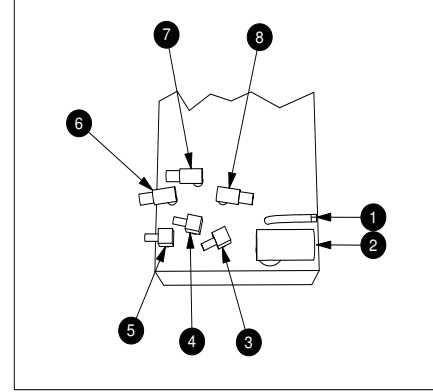

PROPRIETARY AND CONFIDENTIAL.
THE INFORMATION CONTAINED IN THIS DRAWING IS THE SOLE PROPERTY OF REGAL MARINE INDUSTRIES. ANY REPRODUCTION IN PART OR AS WHOLE WITHOUT THE WRITTEN PERMISSION OF REGAL MARINE INDUSTRIES IS PROHIBITED.

REV	REVISION DESCRIPTION	DR. BY	APP. BY	REV. DATE
REGAL MARINE INDUSTRIES 2300 JETPORT DRIVE ORLANDO, FLORIDA 32809 TEL (407) 851-4360 ALL RIGHTS RESERVED				
DRAWING TITLE:				
42(TD/TF) Fuel Tank Location-Install-Routing				
DATE:	10/15/2015	REVISION:	-	PAGE: 1 OF 1
DRAWN BY:	KN	APPROVED BY:	MW	DWG. NO.: MTD23C

42 GRANDE COUPE/FLY FUEL TANK LOCATION/INSTALL OVERVIEW

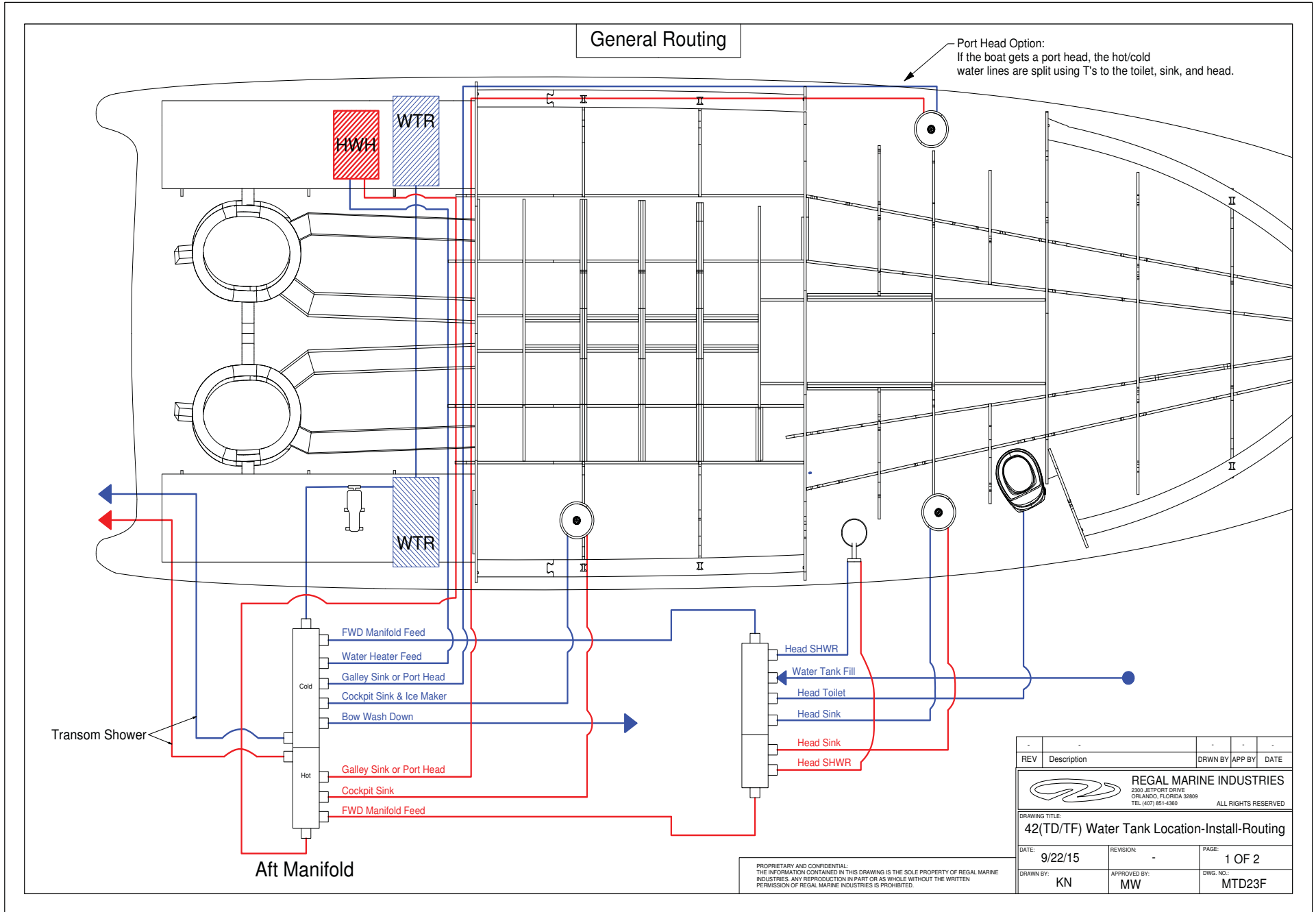

42 GRANDE COUPE/FLY WATER TANK LOCATION

Greywater Routing

Item	Name	Notes
1	Forward AC Unit	
2	Port Refreshment Sink	
3	Port Head Sink	Option
4	Port Head Shower Drain	Option
5	Starboard Head Shower Drain	
6	Starboard Head Sink	
7	Cockpit Sink	
8	Bilge Pump	

Port Head Option

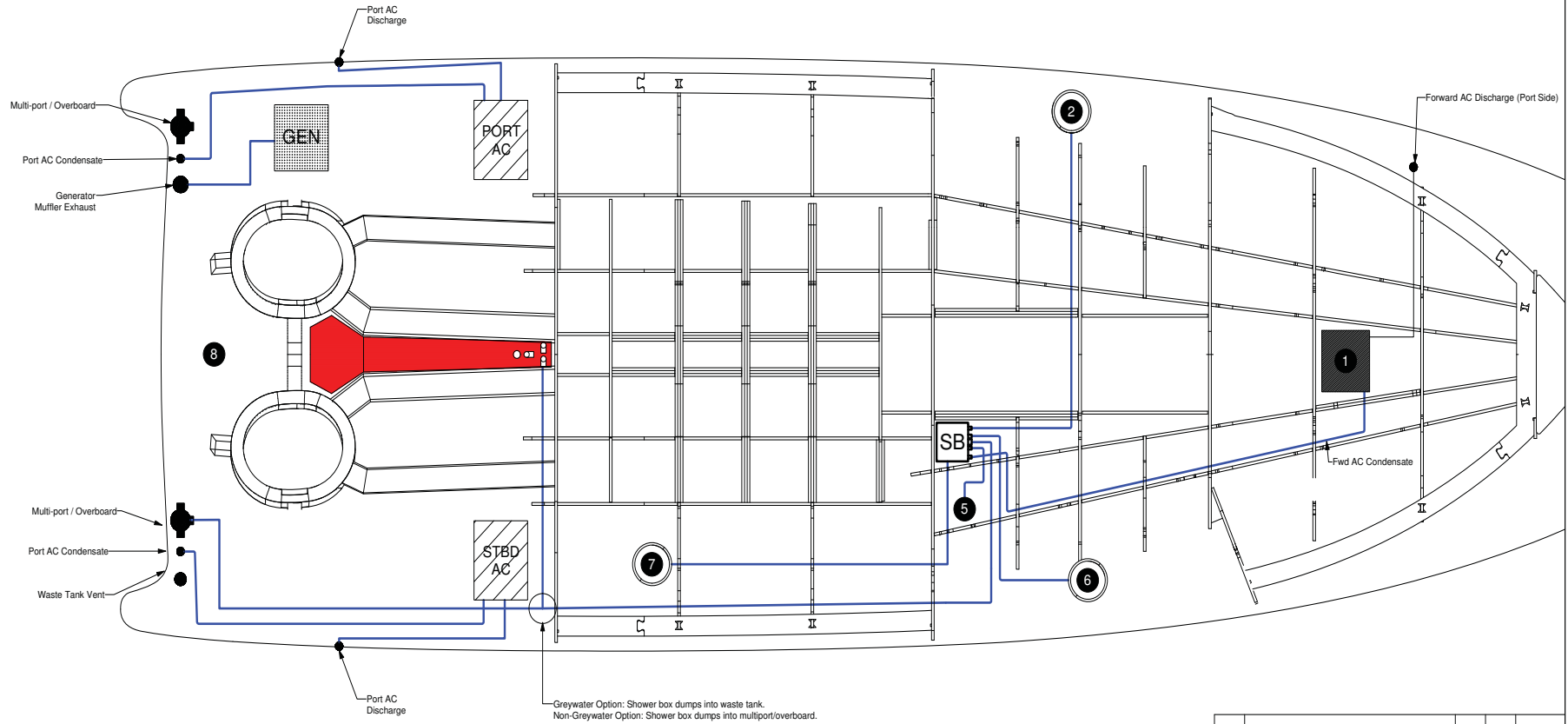
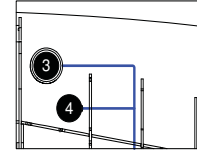

REV	REVISION DESCRIPTION	DR. BY	APP. BY	REV. DATE
-	-	-	-	-

REGAL MARINE INDUSTRIES
2300 JETPORT DRIVE
ORLANDO, FLORIDA 32809
TEL (407) 851-4300 ALL RIGHTS RESERVED

DRAWING TITLE:
42(TD/TF) Black-Grey Water Routing

DATE: 10/12/2015 REVISION: - PAGE: 1 OF 2

DRAWN BY: KN APPROVED BY: MW DWG. NO.: MTD23D

PROPRIETARY AND CONFIDENTIAL
THE INFORMATION CONTAINED IN THIS DRAWING IS THE SOLE PROPERTY OF REGAL MARINE INDUSTRIES. ANY REPRODUCTION IN PART OR AS WHOLE WITHOUT THE WRITTEN PERMISSION OF REGAL MARINE INDUSTRIES IS PROHIBITED.

Deck Level Discharge

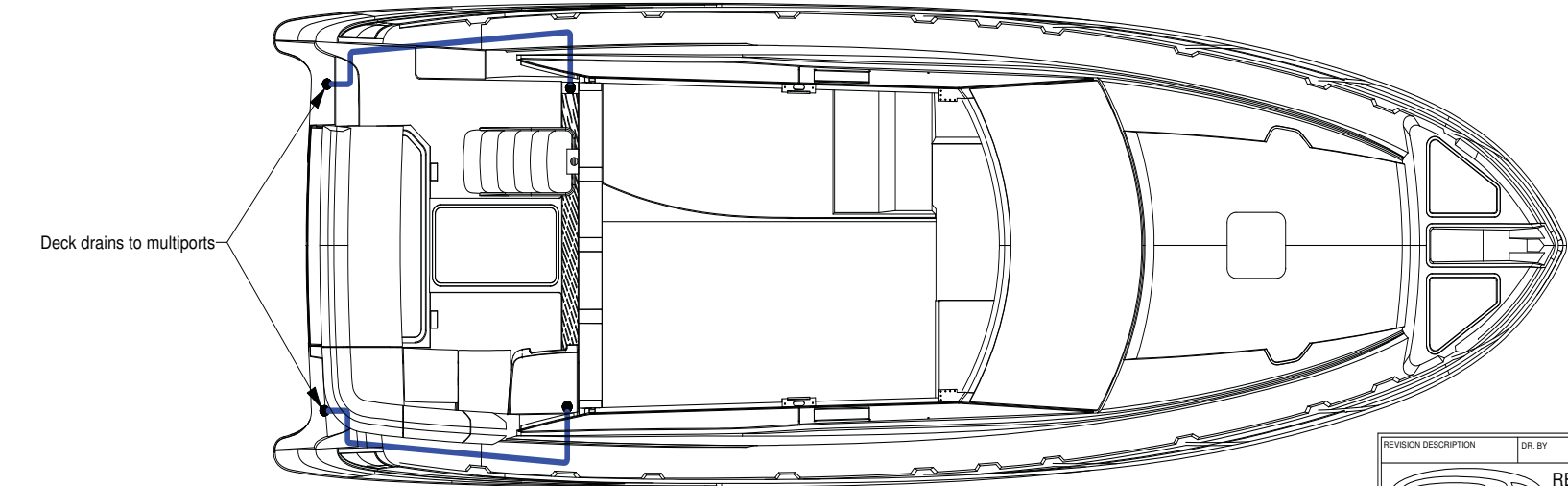
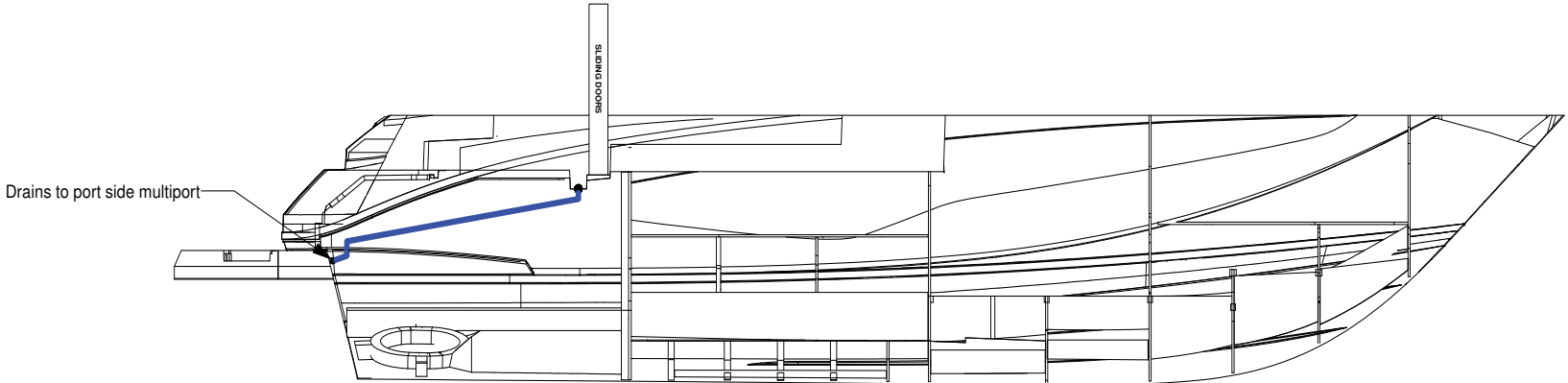

THE INFORMATION CONTAINED IN THIS DRAWING IS THE SOLE PROPERTY OF REGAL MARINE INDUSTRIES. ANY REPRODUCTION IN PART OR AS WHOLE WITHOUT THE WRITTEN PERMISSION OF REGAL MARINE INDUSTRIES IS PROHIBITED

REVISION DESCRIPTION	DR. BY	APP. BY	REV. DATE
 REGAL MARINE INDUSTRIES 2300 JETPORT DRIVE ORLANDO, FLORIDA 32809 TEL. (407) 851-4880 ALL RIGHTS RESERVED			
DRAWING TITLE:			
42(TD/TF) Overboard Discharge			
DATE:	REVISION:	PAGE:	
10/14/2015	-	1 OF 2	
DRAWN BY:	APPROVED BY:	DWG. NO.:	
KN	MW	MTD23G	

42 GRANDE COUPE/FLY OVERBOARD DISCHARGE

Top View

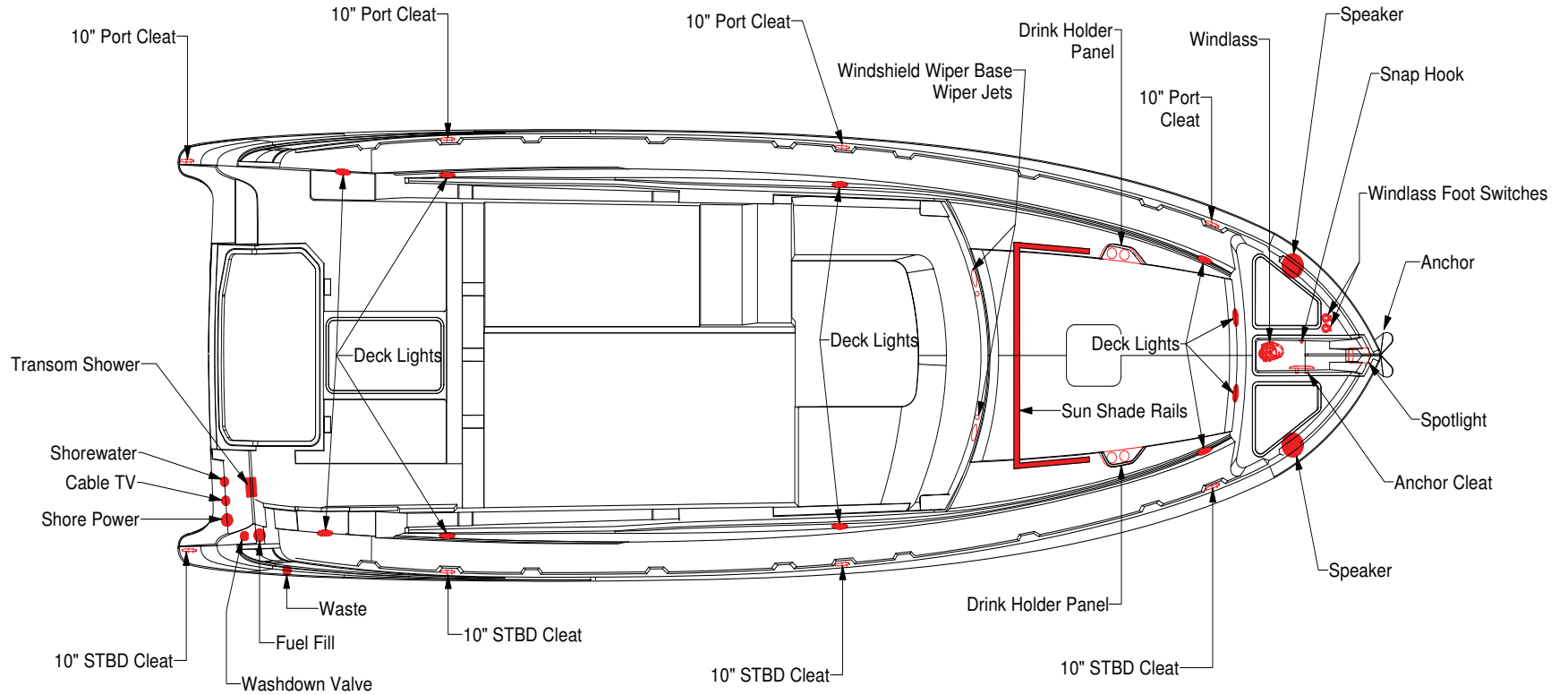

THE INFORMATION CONTAINED IN THIS DRAWING IS THE SOLE PROPERTY OF REGAL MARINE INDUSTRIES. ANY REPRODUCTION IN PART OR AS WHOLE WITHOUT THE WRITTEN PERMISSION OF REGAL MARINE INDUSTRIES IS PROHIBITED

REVISION DESCRIPTION	DR. BY	APP. BY	REV. DATE
 REGAL MARINE INDUSTRIES 2300 JETPORT DRIVE ORLANDO, FLORIDA 32809 TEL (407) 851-4850 ALL RIGHTS RESERVED			
DRAWING TITLE:			
42(TD/TF) Deck Hardware			
DATE:	REVISION:	PAGE:	
1/7/2016	-	1 OF 2	
DRAWN BY:	APPROVED BY:	DWG. NO.:	
KN	MW	MTD24A	

42 GRANDE COUPE/FLY DECK HARDWARE

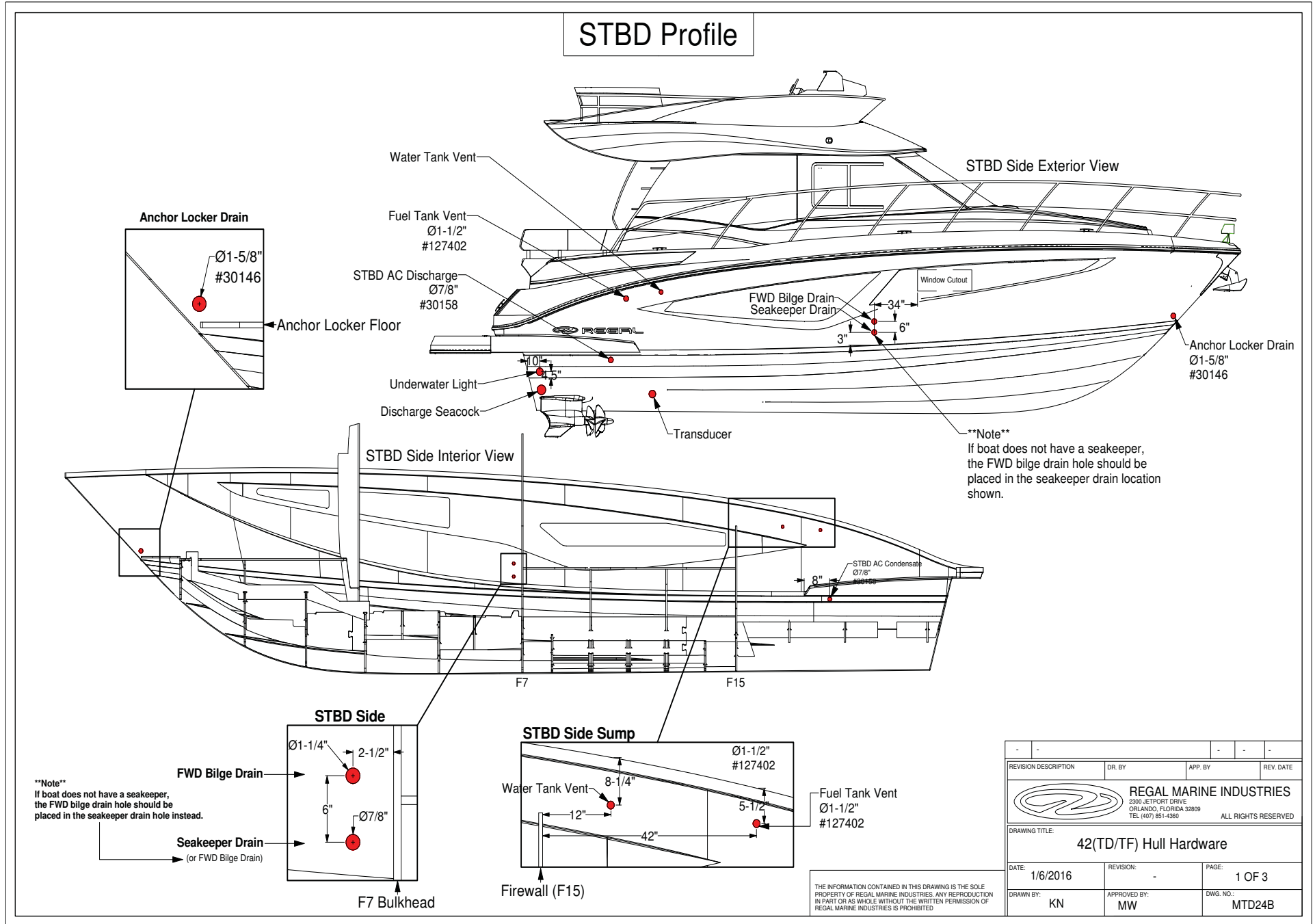

REVISION DESCRIPTION	DR. BY	APP. BY	REV. DATE
REGAL MARINE INDUSTRIES 2300 JETPORT DRIVE ORLANDO, FLORIDA 32809 TEL (407) 851-4850 ALL RIGHTS RESERVED			
DRAWING TITLE:			
42(TD/TF) Hull Hardware			
DATE:	REVISION:	PAGE:	
1/6/2016	-	1 OF 3	
DRAWN BY:	APPROVED BY:	DWG. NO.:	
KN	MW	MTD24B	

42 GRANDE COUPE/FLY HULL HARDWARE

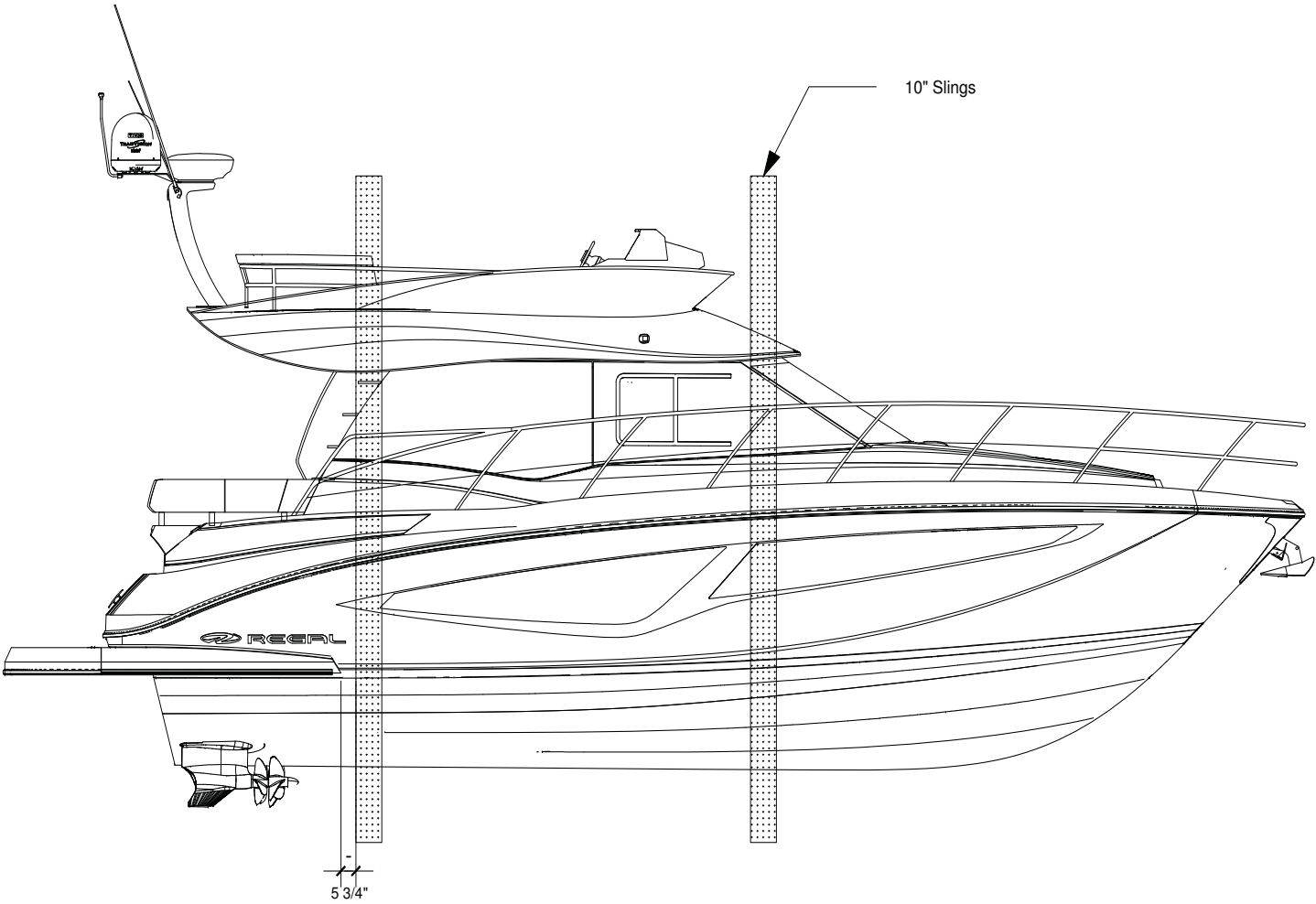

Measured from edge of swim platform to edge of sling

 REGAL MARINE INDUSTRIES 2300 JETPORT DRIVE ORLANDO, FLORIDA 32809 TEL (407) 851-4360		
ALL RIGHTS RESERVED		
DRAWING TITLE:		
42(TD/TF) Sling Locations		
DATE:	REVISION:	PAGE:
4/12/2016	-	1 OF 1
DRAWN BY:	APPROVED BY:	DWG. NO.:
CVL	MW	MTD25F

PROPRIETARY AND CONFIDENTIAL.
 THE INFORMATION CONTAINED IN THIS DRAWING IS THE SOLE PROPERTY OF REGAL MARINE INDUSTRIES. ANY REPRODUCTION IN PART OR AS WHOLE WITHOUT THE WRITTEN PERMISSION OF REGAL MARINE INDUSTRIES IS PROHIBITED.

42 GRANDE COUPE/FLY SLING LOCATIONS

Port + Starboard Locations

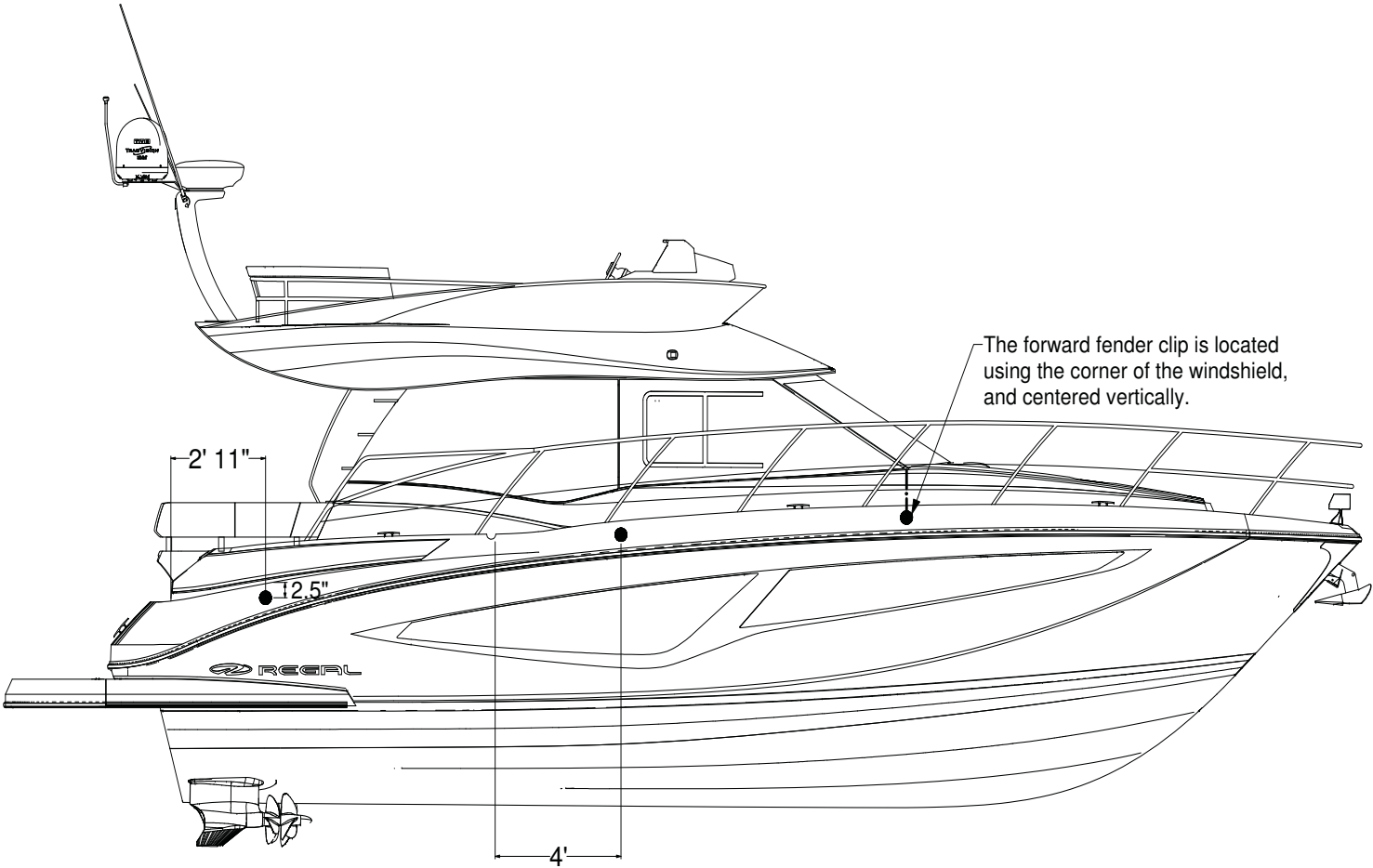

The forward fender clip is located using the corner of the windshield, and centered vertically.

This clip location is 4ft forward from deck groove (drain), and centered vertically.

REVISION DESCRIPTION	DR. BY	APP. BY	REV. DATE
 REGAL MARINE INDUSTRIES 2300 JETPORT DRIVE ORLANDO, FLORIDA 32809 TEL (407) 851-4360 ALL RIGHTS RESERVED			
DRAWING TITLE:			
42(TD/TF) Fender Clip Locations			
DATE:	REVISION:	PAGE:	
1/7/2016	-	1 OF 1	
DRAWN BY:	APPROVED BY:	DWG. NO.:	
KN	MW	MTD25H	

THE INFORMATION CONTAINED IN THIS DRAWING IS THE SOLE PROPERTY OF REGAL MARINE INDUSTRIES. ANY REPRODUCTION IN PART OR AS WHOLE WITHOUT THE WRITTEN PERMISSION OF REGAL MARINE INDUSTRIES IS PROHIBITED.

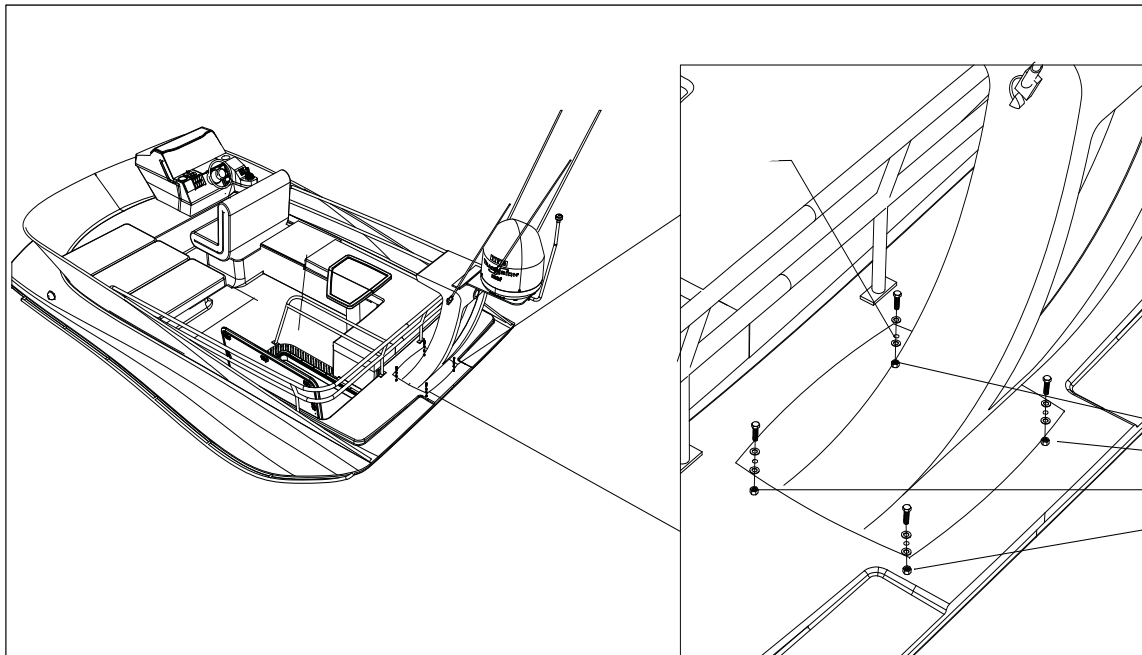

BILL OF MATERIALS		
ITEM	QTY.	DESCRIPTION
1	4	3/8"-16 x 1-1/4" Bolt
2	8	3/8" Fender Washer
3	4	3/8" Hex Nut

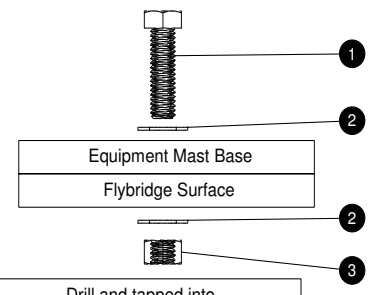

Drill and tapped into imbedded aluminum reinforcement on Centerline (x4)

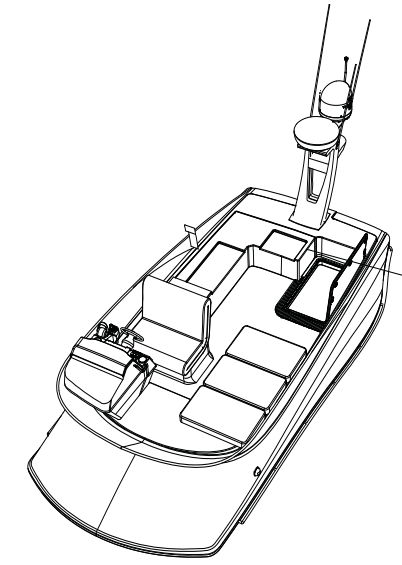
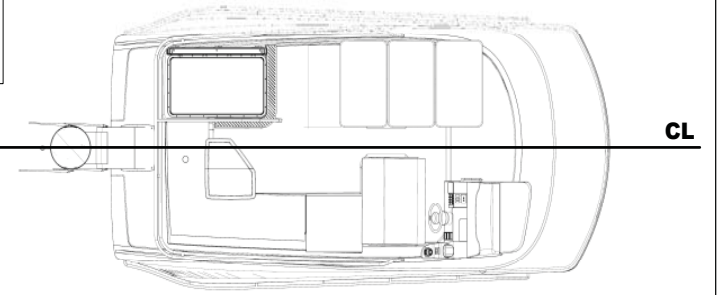

REGAL MARINE INDUSTRIES
 2300 JETPORT DRIVE
 ORLANDO, FLORIDA 32809
 TEL (407) 851-4300 ALL RIGHTS RESERVED

DRAWING TITLE:
40(TD/TF) Equipment Mast Installation

DATE: 3/24/2016	REVISION: -	PAGE: 1 OF 1
DRAWN BY: CVL	APPROVED BY: MW	DWG. NO.: MTD25T

PROPRIETARY AND CONFIDENTIAL:
 THE INFORMATION CONTAINED IN THIS DRAWING IS THE SOLE PROPERTY OF REGAL MARINE INDUSTRIES. ANY REPRODUCTION IN PART OR AS WHOLE WITHOUT THE WRITTEN PERMISSION OF REGAL MARINE INDUSTRIES IS PROHIBITED.

42 GRANDE COUPE/FLY ELECTRONICS MAST



Item	Name	Notes	Item	Name	Notes
1	Engine Batteries		14	Blackwater Tank	
2	Generator Muffler		15	Seawater Pump	
3	Fuel/Water Separator	For Generator	16	Shoreline Reel	
4	Generator		17	Macerator / Discharge Pump	
5	Hot Water Heater		18	Blackwater Vent Filter	
6	Water Tank	Port	19	Gulper Water Pump	
7	Dometic Air Handler	Mounted above water tank	20	Shurflo Water Pump	
8	8D House Battery	All part of shelf extended inboard to hold case	21	Water Manifold	
9	Fuel/Water Separator	For Engine	22	Water Tank	
10	Intake Seacock		23	Dometic Air Handler	Stbd
11	Water Strainer		24	Discharge Seacock	Mounted above water tank
12	Bilge Pump		25	Transducer + Bilge	
13	Fuel/Water Separator	For Engine	26	Fuel Tank Hookups	

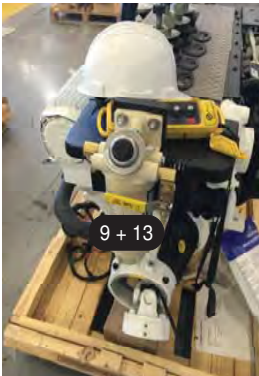
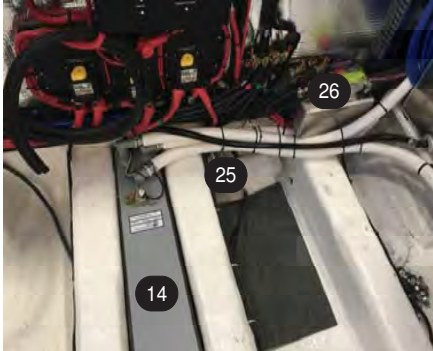

REGAL MARINE INDUSTRIES
 2300 JETPORT DRIVE
 ORLANDO, FLORIDA 32809
 TEL (407) 851-4360 ALL RIGHTS RESERVED

DRAWING TITLE: 42 Component Locations		
DATE: 1/13/2017	REVISION: -	PAGE: 4 OF 4
DRAWN BY: KN	APPROVED BY: D. Reis	DWG. NO.: 5

REFERENCE ONLY
REGAL MARINE INDUSTRIES AND COMPANIES, THE INFORMATION CONTAINED HEREIN IS UNCLASSIFIED AND IS THE SOLE PROPERTY OF REGAL MARINE INDUSTRIES. IT IS TO BE USED ONLY FOR THE PURPOSES AND IN THE MANNER SPECIFIED BY THE ORIGINAL CONTRACTOR OR USER. ALL RIGHTS RESERVED.

42 GRANDE COUPE/FLY COMPONENTS LOCATION

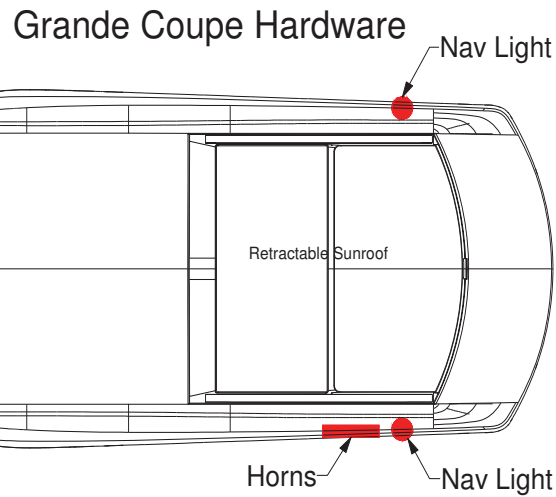
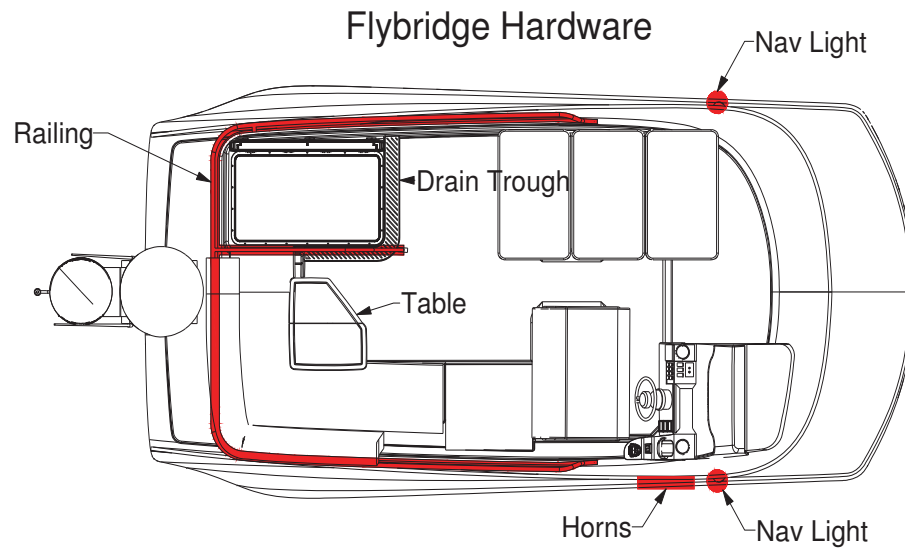

REFERENCE ONLY

REGAL MARINE INDUSTRIES AND COMPANIES
DO NOT WARRANT OR GUARANTEE THE ACCURACY OF THE INFORMATION OR THE MERCHANTABILITY OF THE INFORMATION.
REGAL MARINE INDUSTRIES AND COMPANIES

 REGAL MARINE INDUSTRIES 2300 JETPORT DRIVE ORLANDO, FLORIDA 32809 TEL (407) 851-4360			
DRAWING TITLE:			
42 Deck Hardware			
DATE:	REVISION:	PAGE:	
1/13/2017	-	2 OF 2	
DRAWN BY:	APPROVED BY:	DWG. NO.:	
KN	D. Reis	11	

42 GRANDE COUPE/FLY DECK HARDWARE

Component Locations

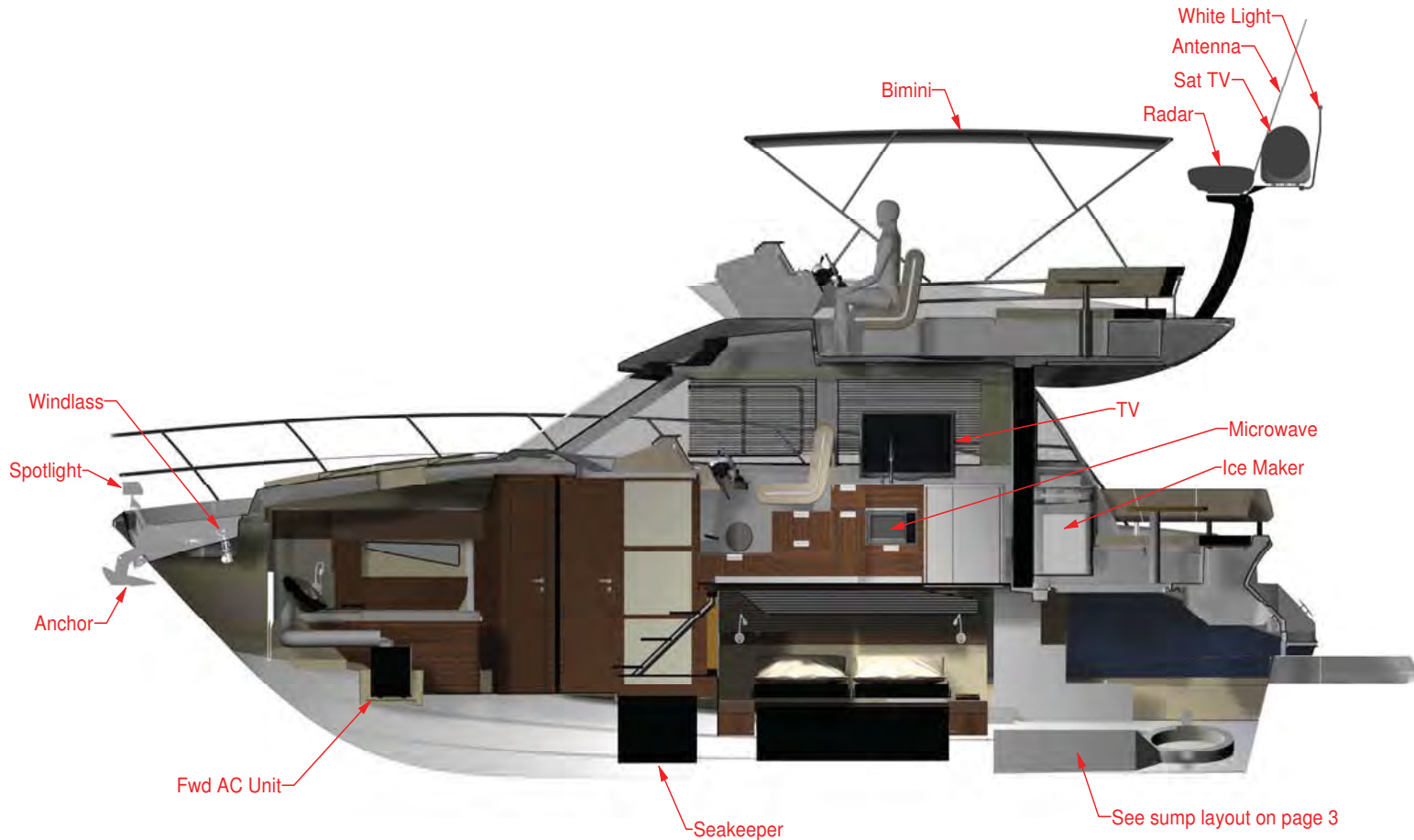

REGAL MARINE INDUSTRIES
 2300 JETPORT DRIVE
 ORLANDO, FLORIDA 32809
 TEL (407) 851-4360 ALL RIGHTS RESERVED

DRAWING TITLE: 42 Component Locations			
DATE: 1/13/2017	REVISION: -	PAGE: 2 OF 4	
DRAWN BY: KN	APPROVED BY: D. Reis	DWG. NO.: 5	

REFERENCE ONLY

 PROPRIETARY AND CONFIDENTIAL. THE INFORMATION CONTAINED HEREIN IS THE SOLE PROPERTY OF REGAL MARINE INDUSTRIES. ANY REPRODUCTION OR TRANSMISSION OF THIS INFORMATION WITHOUT THE WRITTEN PERMISSION OF REGAL MARINE INDUSTRIES IS PROHIBITED.

42 GRANDE COUPE/FLY PORT CUT-AWAY VIEW- HARDWARE

Component Locations

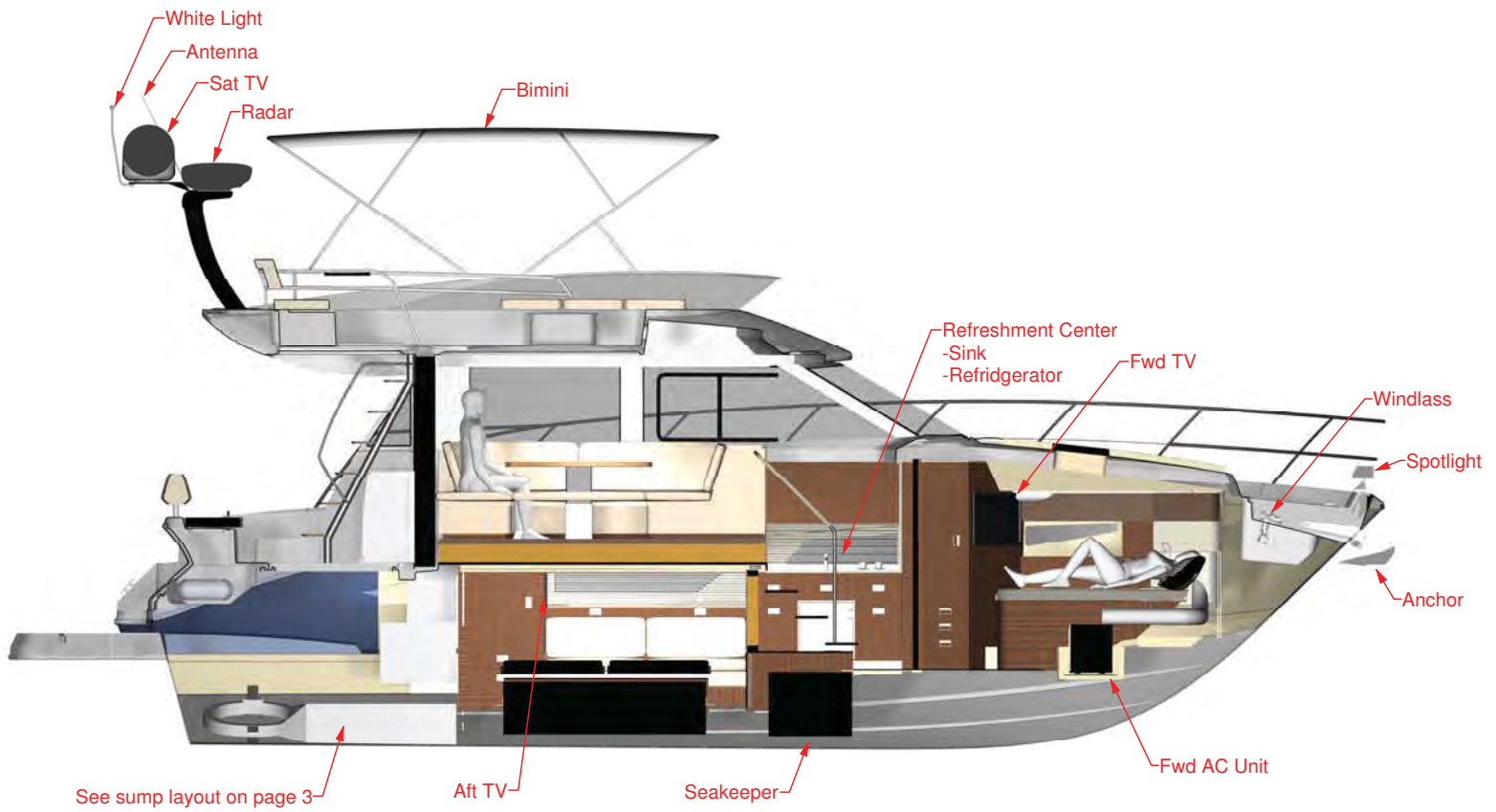

 REGAL MARINE INDUSTRIES 2300 JETPORT DRIVE ORLANDO, FLORIDA 32809 TEL: (407) 851-4365 ALL RIGHTS RESERVED			
DRAWING TITLE: 42 Component Locations			
DATE: 1/13/2017	REVISION: -	PAGE: 1 OF 4	
DRAWN BY: KN	APPROVED BY: D. Reis	DWG. NO.: 5	

REFERENCE ONLY

REGAL MARINE INDUSTRIES AND COMPANIES DO NOT WARRANT THE ACCURACY OF THIS INFORMATION OR THE MERCHANTABILITY OF ANY GOODS OR SERVICES PROVIDED BY REGAL MARINE INDUSTRIES OR ANY OF ITS COMPANIES.

42 GRANDE COUPE/FLY STBD. CUT-AWAY VIEW- HARDWARE

42 Fly Dimensions

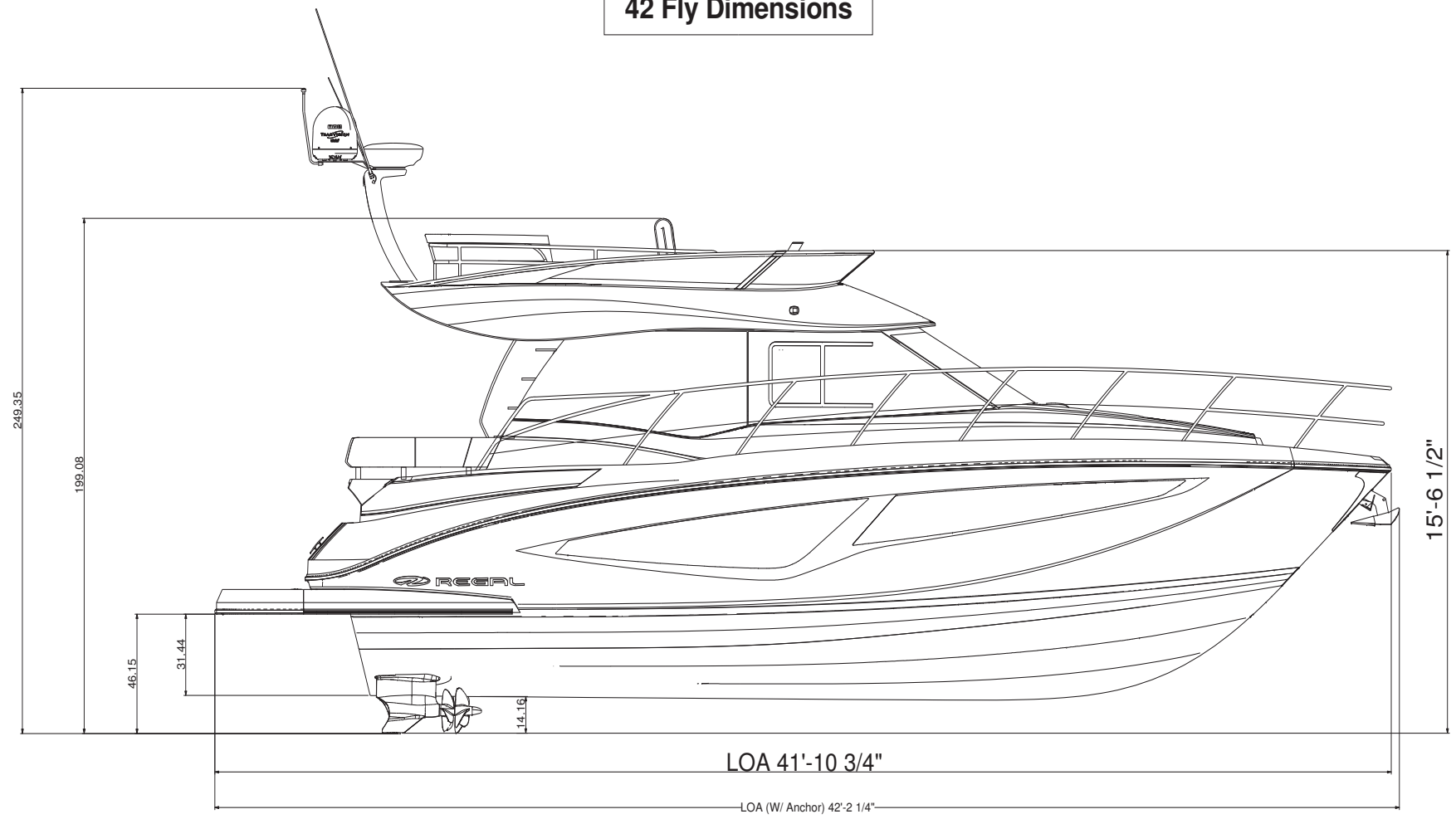

	REGAL MARINE INDUSTRIES 2300 JETPORT DRIVE GULF BEND, FLORIDA 32809 TEL (407) 851-4360			ALL RIGHTS RESERVED
	DRAWING TITLE: 42 Dimensions			
REFERENCE ONLY	DATE: 1/13/2017	REVISION: -	PAGE: 1 OF 2	
PROPRIETARY AND CONFIDENTIAL ALL RIGHTS ARE RESERVED TO REGAL MARINE INDUSTRIES. NO PART OF THIS DRAWING OR THE INFORMATION CONTAINED HEREIN IS TO BE REPRODUCED OR TRANSMITTED IN ANY FORM OR BY ANY MEANS, ELECTRONIC OR MECHANICAL, INCLUDING PHOTOCOPYING, RECORDING, OR BY ANY INFORMATION STORAGE AND RETRIEVAL SYSTEM, WITHOUT THE WRITTEN PERMISSION OF REGAL MARINE INDUSTRIES.	DRAWN BY: KN	APPROVED BY: D. Reis	DWG. NO.: 3	

42 FLY DIMENSIONS

42 Grande Coupe Dimensions

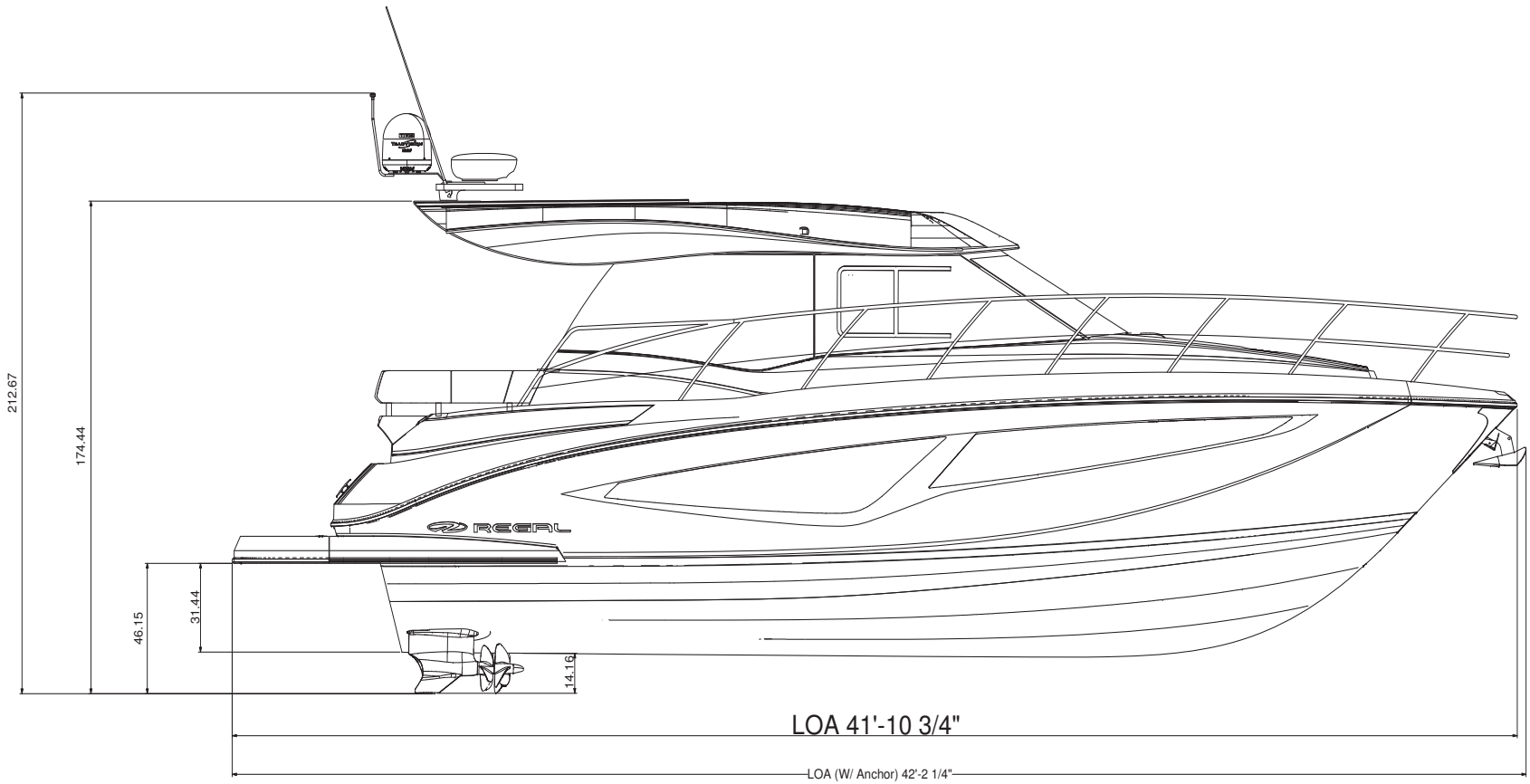

 REGAL MARINE INDUSTRIES 2300 JETPORT DRIVE CLEVELAND, FLORIDA 32809 TEL (407) 851-4360		ALL RIGHTS RESERVED			
		DRAWING TITLE: 42 Dimensions			
DATE:	1/13/2017	REVISION:	-	PAGE:	2 OF 2
DRAWN BY:	KN	APPROVED BY:	D. Reis	DWG. NO.:	3

REFERENCE ONLY

REGAL MARINE AND COMPANY
DO NOT BE RESPONSIBLE FOR THE CONTENTS OF THIS DRAWING IN THE SALE PROPERTY OF REGAL MARINE
INDUSTRIES. THE INFORMATION CONTAINED HEREIN IS THE PROPERTY OF REGAL MARINE INDUSTRIES AND IS NOT TO BE
REPRODUCED OR TRANSMITTED IN ANY FORM OR BY ANY MEANS, ELECTRONIC OR MECHANICAL, INCLUDING
PHOTOCOPYING, RECORDING, OR BY ANY INFORMATION STORAGE AND RETRIEVAL SYSTEM.

42 GRANDE COUPE DIMENSIONS